

Voltage selector switch with fuseholder, 6 stages, step switch, panel mounting



See below:

Approvals and Compliances

Description

- Voltage Selector , with fuseholder , 6 stages
- Step switch
- For 5 x 20 mm fuse-links
- Solder terminals

References

We recommend for new applications the type **SWP**
 Last order date: 31.12.2016

Technical Data

Ratings	IEC: 6.3 A / 250 VAC; 50 Hz UL: 6.3 A / 250 VAC; 60 Hz CSA: 10 A / 250 VAC; 60 Hz	Solderability	350 °C / 2 sec acc. to IEC 60068-2-20, Test Ta, method 2
Mounting	Panel mount from front side	Resistance to Soldering Heat	350 °C / 10 sec acc. to IEC 60068-2-20, Test Tb, method 2
Attachment	Screw-on mounting	Insulation Resistance	> 10'000MΩ (500VDC; 1min)
Terminal	Solder	Contact Resistance	< 10mΩ at 20 mV
Number of Stages	6	Dielectric Strength	> 2kVAC between L-N > 4kVAC between L/N-PE (1min; 50Hz)
Lifetime	300 operating cycles (without load)	Clearance and Creepage Distance	> 3mm > 8mm between L/N-PE
Degree of Protection	IP 40	Resistance to Vibration	acc. to IEC 60068-2-6, test Fc
Shock-Safe Category	PC2		
Protection Class	Suitable for appliances with protection class II acc. to IEC 61140		
Allowable Operation Temperature	-40 °C to 70 °C		
Climatic Category	25/85/21 acc. to IEC 60068-1		
Material: Socket	Thermoplastic, black, UL 94V-0		
Weight	20.4 g		

Approvals and Compliances



Detailed information on product approvals, code requirements, usage instructions and detailed test conditions can be looked up in [Details about Approvals](#)

SCHURTER products are designed for use in industrial environments. They have approvals from independent testing bodies according to national and international standards. Products with specific characteristics and requirements such as required in the automotive sector according to IATF 16949, medical technology according to ISO 134485 or in the aerospace industry can be offered exclusively with customer-specific, individual agreements by SCHURTER.

Approvals



The approval mark is used by the testing authorities to certify compliance with the safety requirements placed on electronic products.

Approval Reference Type: SWK

Approval Logo	Certificates	Certification Body	Description
	UL Approvals	UL	UL File Number: E72661
	CSA Approvals	CSA	CSA Certification Record: LR45945
	SEMKO Approvals	SEMKO	Svenska Elektriska Materielkontrollanstalten

Product standards

Product standards that are referenced

Organization	Design	Standard	Description
	Designed according to	UL 508	Industrial control equipment
	Designed according to	CSA C22.2 no. 55	Fuseholder general requirements



Application standards

Application standards where the product can be used

Organization	Design	Standard	Description
	Designed for applications acc.	IEC/UL 60950	IEC 60950-1 includes the basic requirements for the safety of information technology equipment.

Compliances

The product complies with following Guide Lines

Identification	Details	Initiator	Description
	CE declaration of conformity	SCHURTER AG	The CE marking declares that the product complies with the applicable requirements laid down in the harmonisation of Community legislation on its affixing in accordance with EU Regulation 765/2008.
	REACH	SCHURTER AG	On 1 June 2007, Regulation (EC) No 1907/2006 on the Registration, Evaluation, Authorization and Restriction of Chemicals 1 (abbreviated as "REACH") entered into force.

Dimension [mm]

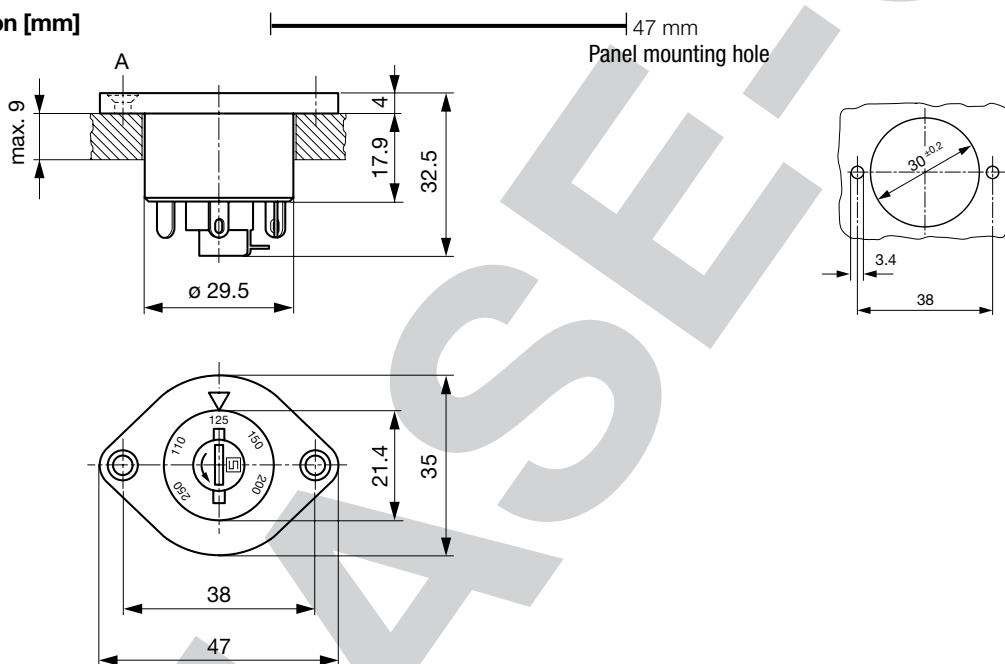

A) Hole for M3

Diagrams

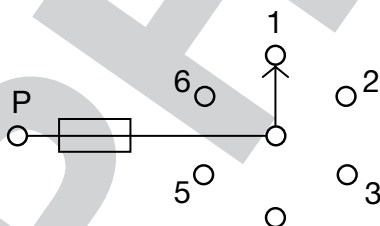

All Variants

Letterings						Order Number
Stage 1	Stage 2	Stage 3	Stage 4	Stage 5	Stage 6	
110	125	150	200	220	250	0033.1500

Availability for all products can be searched real-time:<https://www.schurter.com/en/Stock-Check/Stock-Check-SCHURTER>

Packaging Unit 50 Pcs

Mouser Electronics

Authorized Distributor

Click to View Pricing, Inventory, Delivery & Lifecycle Information:

Schurter:

[0033.1501](#) [0033.1502](#) [0033.1504](#) [0033.1509](#) [0033.1511](#) [0033.1513](#) [0033.1514](#) [0033.1517](#) [0033.1523](#) [0033.1500](#)