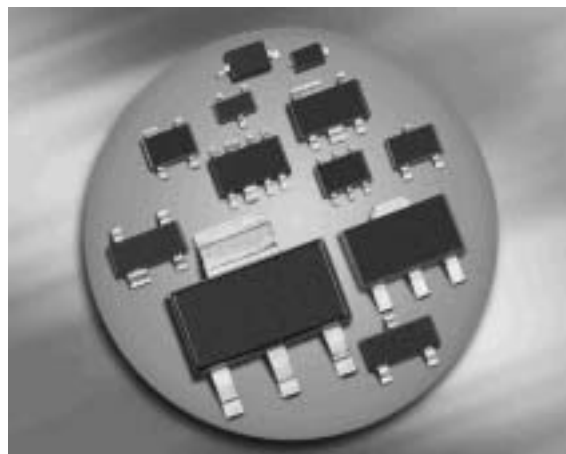
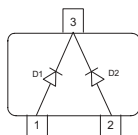
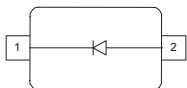

Silicon Tuning Diodes

- High capacitance ratio
- High Q hyperabrupt tuning diode
- Low series resistance
- Designed for low tuning voltage operation for VCO's in mobile communications equipment
- Very low capacitance spread
- Pb-free (RoHS compliant) package ¹⁾
- Qualified according AEC Q101

BBY66-02V
**BBY66-05
BBY66-05W**

Type	Package	Configuration	L_S (nH)	Marking
BBY66-02V	SC79	single	0.6	h
BBY66-05	SOT23	common cathode	1.8	O1s / O2s**
BBY66-05W	SOT323	common cathode	1.4	OBs

**For differences see next page Capacitance groups

Maximum Ratings at $T_A = 25^\circ\text{C}$, unless otherwise specified

Parameter	Symbol	Value	Unit
Diode reverse voltage	V_R	12	V
Forward current	I_F	50	mA
Operating temperature range	T_{op}	-55 ... 150	°C
Storage temperature	T_{stg}	-55 ... 150	

¹⁾Pb-containing package may be available upon special request

Electrical Characteristics at $T_A = 25^\circ\text{C}$, unless otherwise specified

Parameter	Symbol	Values			Unit
		min.	typ.	max.	
DC Characteristics					
Reverse current $V_R = 10\text{ V}$ $V_R = 10\text{ V}, T_A = 65^\circ\text{C}$	I_R	-	-	20 200	nA
AC Characteristics					
Diode capacitance ¹⁾ $V_R = 1\text{ V}, f = 1\text{ MHz}$ $V_R = 2\text{ V}, f = 1\text{ MHz}$ $V_R = 3\text{ V}, f = 1\text{ MHz}$ $V_R = 4.5\text{ V}, f = 1\text{ MHz}$	C_T	66 33 19.7 12	68.7 35.4 20.95 12.7	71.5 38 22.2 13.5	pF
Capacitance ratio $V_R = 1\text{ V}, V_R = 4.5\text{ V}$	$C_{T1}/C_{T4.5}$	5	5.41	-	
Series resistance $V_R = 1\text{ V}, f = 470\text{ MHz}$	r_S	-	0.25	0.4	Ω

¹Capacitance groups at 1V, coded 01; 02 (only BBY66-05)

C_T /groups	01	02
C_{1V} min	66pF	68.5pF
C_{1V} max	69pF	71.5pF

Deliveries contain either C_T group 01 or group 02 (marked on reel).

No direct order of C_T groups possible

Diode capacitance $C_T = f(V_R)$

$f = 1\text{MHz}$

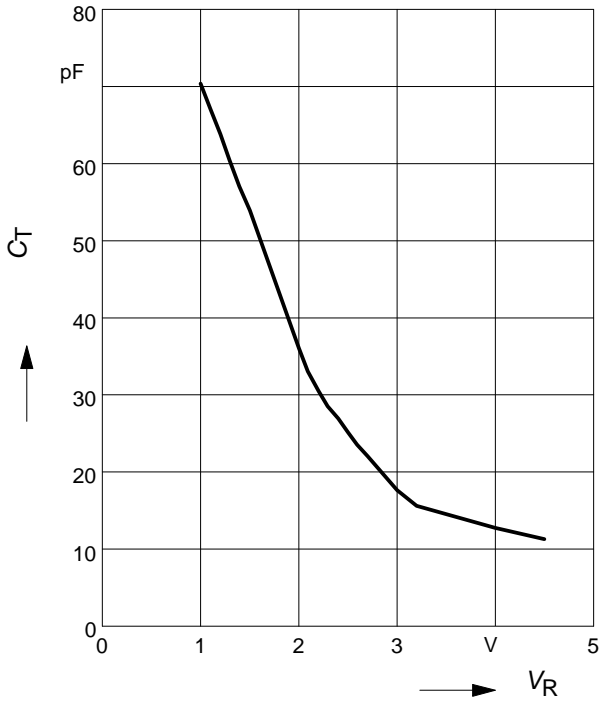

Temperature coefficient of the diode capacitance $T_{CC} = f(V_R)$

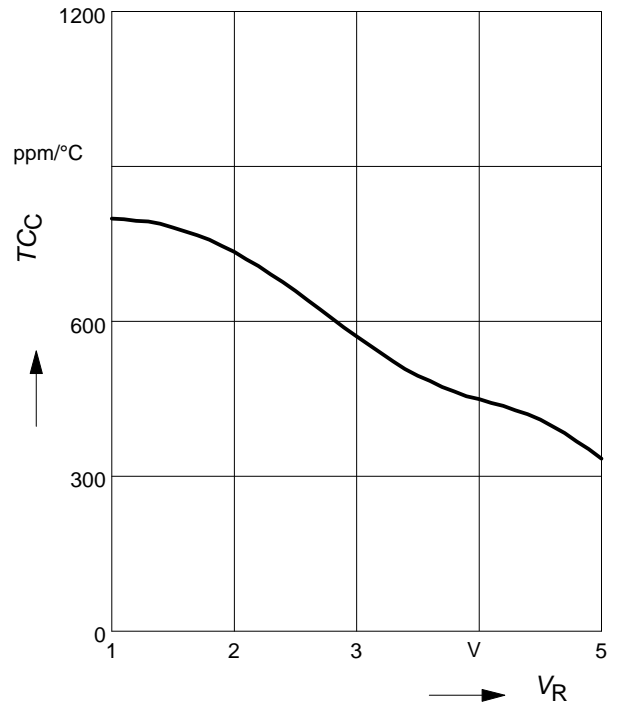

Reverse current $I_R = f(V_R)$

$T_A = \text{Parameter}$

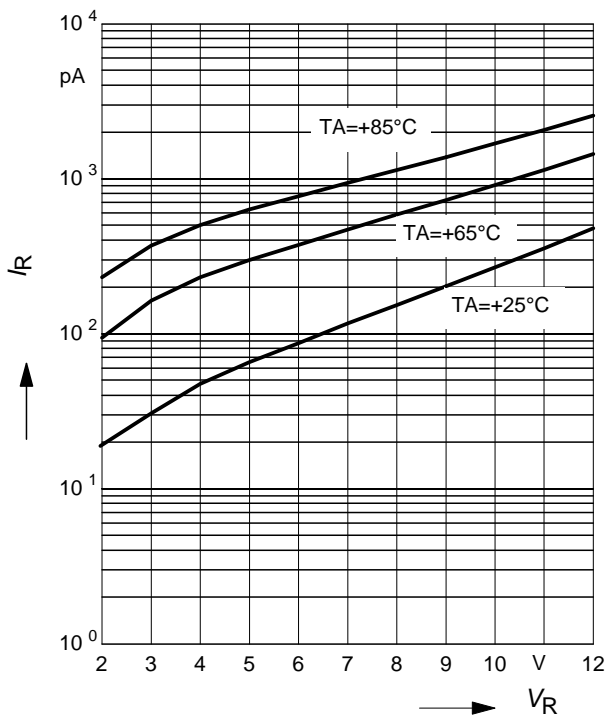

Package Outline

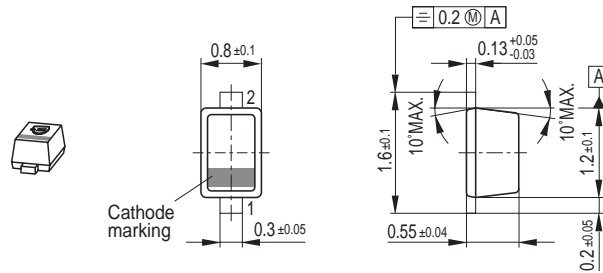

Foot Print

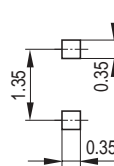

Marking Layout (Example)

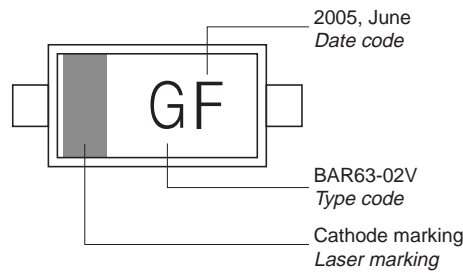

Standard Packing

Reel \varnothing 180 mm = 3.000 Pieces/Reel
 Reel \varnothing 180 mm = 8.000 Pieces/Reel (2 mm Pitch)
 Reel \varnothing 330 mm = 10.000 Pieces/Reel



Date Code marking for discrete packages with one digit (SCD80, SC79, SC75¹⁾) CES-Code

Month	2003	2004	2005	2006	2007	2008	2009	2010	2011	2012	2013	2014
01	a	p	A	P	a	p	A	P	a	p	A	P
02	b	q	B	Q	b	q	B	Q	b	q	B	Q
03	c	r	C	R	c	r	C	R	c	r	C	R
04	d	s	D	S	d	s	D	S	d	s	D	S
05	e	t	E	T	e	t	E	T	e	t	E	T
06	f	u	F	U	f	u	F	U	f	u	F	U
07	g	v	G	V	g	v	G	V	g	v	G	V
08	h	x	H	X	h	x	H	X	h	x	H	X
09	j	y	J	Y	j	y	J	Y	j	y	J	Y
10	k	z	K	Z	k	z	K	Z	k	z	K	Z
11	l	2	L	4	l	2	L	4	l	2	L	4
12	n	3	N	5	n	3	N	5	n	3	N	5

1) New Marking Layout for SC75, implemented at October 2005.

Package Outline



1) Lead width can be 0.6 max. in dambar area

Foot Print

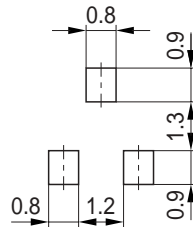

Marking Layout (Example)

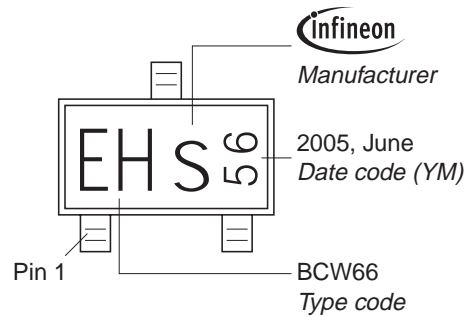

Standard Packing

Reel \varnothing 180 mm = 3.000 Pieces/Reel
 Reel \varnothing 330 mm = 10.000 Pieces/Reel

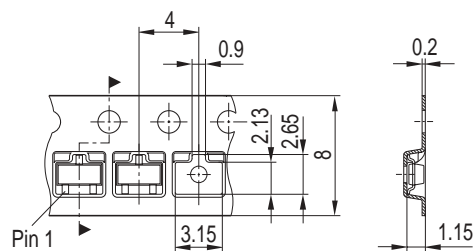

Package Outline

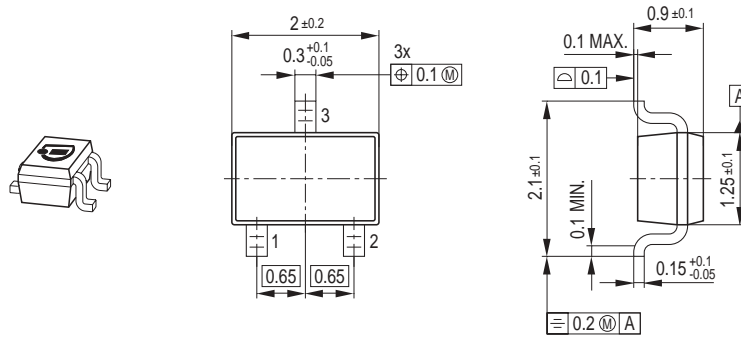

Foot Print

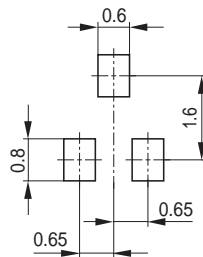

Marking Layout (Example)

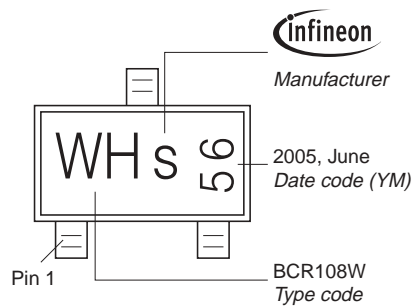

Standard Packing

Reel \varnothing 180 mm = 3.000 Pieces/Reel
 Reel \varnothing 330 mm = 10.000 Pieces/Reel

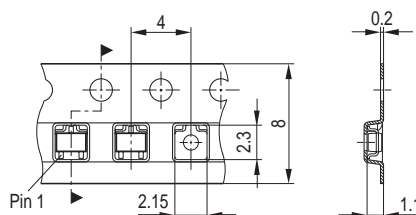

Edition 2006-02-01
Published by
Infineon Technologies AG
81726 München, Germany
© Infineon Technologies AG 2007.
All Rights Reserved.

Attention please!

The information given in this dokument shall in no event be regarded as a guarantee of conditions or characteristics ("Beschaffenheitsgarantie"). With respect to any examples or hints given herein, any typical values stated herein and/or any information regarding the application of the device, Infineon Technologies hereby disclaims any and all warranties and liabilities of any kind, including without limitation warranties of non-infringement of intellectual property rights of any third party.

Information

For further information on technology, delivery terms and conditions and prices please contact your nearest Infineon Technologies Office (www.infineon.com).

Warnings

Due to technical requirements components may contain dangerous substances. For information on the types in question please contact your nearest Infineon Technologies Office.

Infineon Technologies Components may only be used in life-support devices or systems with the express written approval of Infineon Technologies, if a failure of such components can reasonably be expected to cause the failure of that life-support device or system, or to affect the safety or effectiveness of that device or system.

Life support devices or systems are intended to be implanted in the human body, or to support and/or maintain and sustain and/or protect human life. If they fail, it is reasonable to assume that the health of the user or other persons may be endangered.

Mouser Electronics

Authorized Distributor

Click to View Pricing, Inventory, Delivery & Lifecycle Information:

[Infineon:](#)

[BBY 66-02V E6327](#) [BBY 66-02V H6327](#) [BBY 66-05W H6327](#) [BBY 66-05W E6327](#) [BBY 66-05 E6327](#)
[BBY6602VH6327XTSA1](#)