

PB2 Series

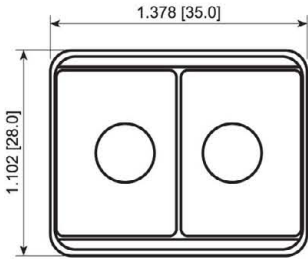

Suggested Panel Cutout

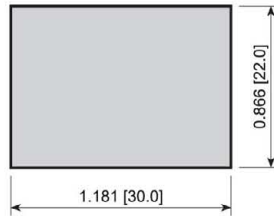

Illumination Options

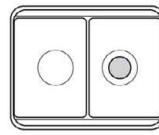

Round Lens

Terminal Options

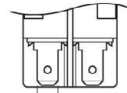

4.8mm Tab

Safety Lock Option

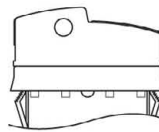

Safety Lock

FEATURES:

- Popular 22mm x 30mm Cutout
- High Power Ratings
- Internal O-rings for Water Resistance
- Illumination Options

SPECIFICATIONS:

RATING: 20A 125VAC [cURus UL508]
12A 250VAC [cURus UL508]
European Approvals Pending

TEMPERATURE: -20°C to 85°C

ELECTRICAL LIFE: 10,000 Cycles

CONTACT RESISTANCE: 50mΩ Max.

INSULATION RESISTANCE: 5MΩ Min. at 500VDC

DIELECTRIC STRENGTH: 1,500VAC for 1 Minute

INGRESS PROTECTION: IP54

MATERIALS:

Body: Polyamide 6/6
BEZEL: Polyamide 6/6
ACTUATOR: Polyamide 6/6
Lens: Polycarbonate
GASKET: Polyvinyl Chloride
CONTACTS: Silver Plated Copper
TERMINALS: Silver Plated Brass
O-Ring: Silicone

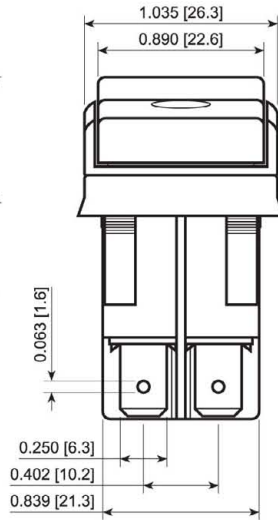
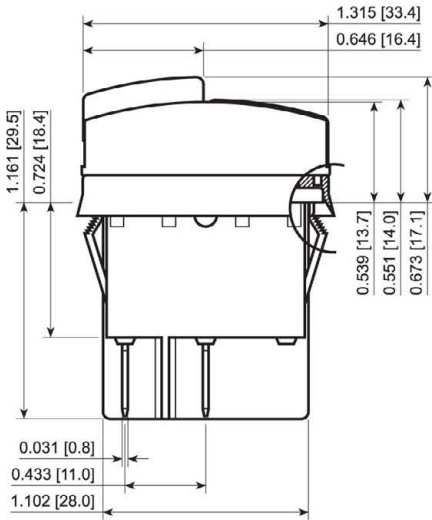

PB242D1100

SPECIFICATIONS SUBJECT TO CHANGE WITHOUT NOTICE

Series	Terminal	Function	Rating	Body Color	Actuator Color	Marking Color	Marking Type	Lens Style	Lens Color	Lamp Voltage
<input type="checkbox"/> PB2 - Std. Version	<input type="checkbox"/> 1 - 4.8mm Tab	<input type="checkbox"/> 1 Pole:	<input type="checkbox"/> D - 20A 125VAC	<input type="checkbox"/> 1 - Black	<input type="checkbox"/> 1 - Black	<input type="checkbox"/> 0 - None	<input type="checkbox"/> 0 - None	<input type="checkbox"/> 2 - Round	<input type="checkbox"/> 0 - Clear	<input type="checkbox"/> 3 - 6V
<input type="checkbox"/> PB2L - Safety Lock	<input type="checkbox"/> 4 - 6.3mm Tab	<input type="checkbox"/> 1 - Off-On	<input type="checkbox"/> 12A 250VAC	<input type="checkbox"/> 2 - White	<input type="checkbox"/> 2 - White	<input type="checkbox"/> 1 - Black	<input type="checkbox"/> 1 - I/O Vert.	<input type="checkbox"/>	<input type="checkbox"/> 1 - Red	<input type="checkbox"/> 4 - 12V
		<input type="checkbox"/> 3 - On-On		<input type="checkbox"/> A - Red/Green	<input type="checkbox"/> 2 - White	<input type="checkbox"/> 2 - White	<input type="checkbox"/> 3 - ON/OFF Vert.		<input type="checkbox"/> 2 - Amber	<input type="checkbox"/> 5 - 24V
		<input type="checkbox"/> 2 Pole:				<input type="checkbox"/> 1 - I/O Horiz.	<input type="checkbox"/> R - I/O Horiz.		<input type="checkbox"/> 3 - Green	<input type="checkbox"/> 6 - 125V
		<input type="checkbox"/> 2 - Off-On							<input type="checkbox"/> 4 - Blue	<input type="checkbox"/> 7 - 250V
		<input type="checkbox"/> G - On-On								

Custom Colors and Markings Available Upon Request

For Illuminated Switches Only

EXAMPLE PART NUMBERS:

PB242D1100 **2P Off-On**
Black Body/Actuator, No Marking



E-SWITCH®

www.e-switch.com

800.867.2717

PUSHBUTTON

Mouser Electronics

Authorized Distributor

Click to View Pricing, Inventory, Delivery & Lifecycle Information:

[E-Switch:](#)

[PB242D212R-207T](#) [PB241D212Z02T](#) [PB242D1A2R-236](#) [PB242D1100](#)