



Introducing ZDC RF Coax Connector Series 50 & 75 Ohm

ZDC RF Coax Connector Series 50 & 75 Ohm



Our commitment. Your advantage.

KEY FEATURES

Bayonet Coupling for rapid connectivity

Threaded Coupling to provide secure termination

Multiple PCB mounting options and styles

INTRODUCTION

The RoHS compliant ZDC Coax Connector series from Tyco Electronics offers quality cost effective solutions for commercial applications by the use of precision die-cast components, and thermoplastic dielectrics. This brochure showcases some of the popular BNC interface part numbers in a variety of styles. The ZDC line also includes parts with TNC, UHF, M-UHF, F and SMA interface.

The connector interfaces are compatible with the requirements of MIL-C-39012 and MIL STD348A, and are therefore intermateable with products manufactured to these specifications. Available in a range of cable mounted plugs and jacks, bulkhead and PCB sockets, the Tyco Electronics ZDC Coax Connector range offers a comprehensive choice of solutions for cost demanding applications. The crimp connectors utilize standard hexagonal crimp tools and die-sets avoiding costly retooling.

DESCRIPTION

RoHS compliant coax crimp and PCB styles

Precision die-cast construction

Interface meets MIL STD348A

Available in plug, jack, socket and adaptor types

Standard hexagonal crimp hand tool and dies

Terminates to popular RG coax cables

MECHANICAL

Operating temperature range -55°C to +85°C

Durability 50 cycles minimum

APPLICATIONS

Instrumentation

Medical equipment

Industrial process and control

Transportation

CCTV monitoring



ZDC RF Coax Connector Series 50 & 75 Ohm

ELECTRICAL

50 Ohm and 75 Ohm impedance
DC - 4GHz frequency range

MATERIALS

Nickel plated zinc die cast construction
Gold plated center contact and thermoplastic dielectric

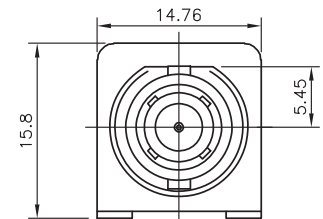
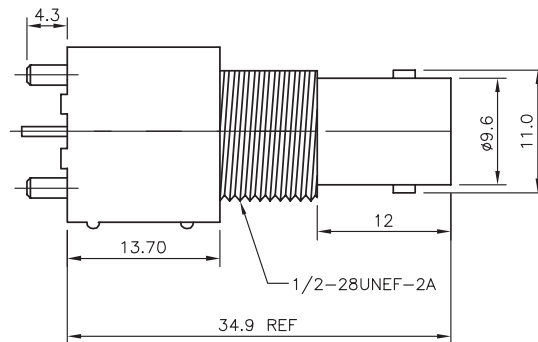
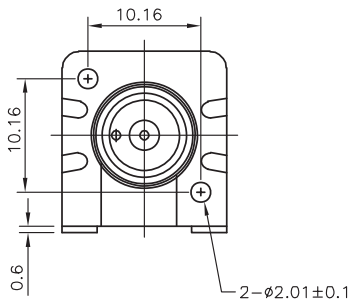

RECOMMENDED PCB LAYOUT
WITH MOUNTING POSTS OR BOARD LOCKS

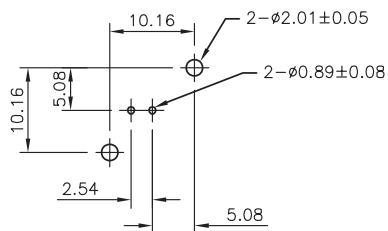

RECOMMENDED MOUNTING HOLE
MAX PANEL THICKNESS: 5.5mm

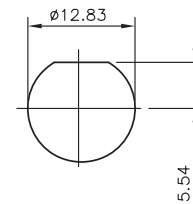

PRODUCT OFFERING & DIMENSIONS

BNC Straight Plug Crimp

TE Part Number	Ohms	Cable Group
5-1634500-1	50	RG174
5-1634500-2	50	RG58
5-1634502-4	75	RG179
5-1634502-2	75	RG59



BNC Straight Jack Crimp

TE Part Number	Ohms	Cable Group
5-1634511-1	50	RG174
5-1634511-2	50	RG58
5-1634514-1	75	RG59



BNC Bulkhead Jack Rear Mount

TE Part Number	Ohms	Cable Group
5-1634516-1	50	RG58
5-1624516-3	75	RG179
5-1634516-5	75	RG59



BNC Bulkhead Socket Front Mount

TE Part Number	Ohms	Cable Group
5-1634523-1	50	-
5-1634523-2	75	-



BNC Bulkhead Socket Rear Mount

TE Part Number	Ohms	Cable Group
5-1634518-1	50	-
5-1634518-3	75	-



BNC Insulated Bulkhead Socket

TE Part Number	Ohms	Cable Group
5-1634504-1	50	-
5-1634504-2	75	-



BNC Elbow PCB Socket - Insulated*

TE Part Number	Ohms	Description
1-1337542-0	50	White Low Profile
1-1337543-0	50	White Std Profile
1-1634613-0	50	Black Low Profile
1-1634612-0	50	Black Std Profile
1-1478031-0	75	White Low Profile
1-1478032-0	75	White Std Profile
1-1634624-0	75	Black Low Profile
1-1634622-0	75	Black Std Profile



BNC Elbow PCB Socket - Metal*

TE Part Number	Ohms	Description
1-1337494-0	50	Metal Std Profile
1-1634508-0	75	Metal Std Profile



***BNC PCB Accessories for Noted Series**

TE Part Number	Description
1-1634817-0	Lockwasher
1-1634816-0	Hex Nut



ZDC RF Coax Connector Series 50 & 75 Ohm

PRODUCT OFFERING & DIMENSIONS

BNC Straight PCB Socket - Insulated*

TE Part Number	Ohms	Description
1-1337541-0	50	White
1-1634505-0	50	Black
1-1478033-0	75	White
1-1634629-0	75	Black



BNC Straight PCB Socket - Metal

TE Part Number	Ohms	Description
5-1634503-1	50	Metal
5-1634503-3	75	Metal



BNC Straight Adaptors

TE Part Number	Ohms	Description
5-1634534-1	50	Jack - Jack



BNC T - Adaptors

TE Part Number	Ohms	Description
5-1634532-1	50	Jack - Plug - Jack



TECHNICAL SPECIFICATIONS

Nominal Impedance	50Ω and 75Ω
Working Voltage	500Vrms
Contact Resistance	1.5mΩ max
Insulation Resistance (initial)	5000MΩ min
Dielectric Withstand Voltage	1500Vrms (sea level)
Frequency Range	0-4GHz (50Ω) 0-2GHz (75Ω)
VSWR	
DC - 2GHz	Straight 1.15 max
Durability (Cycles)	50
Temperature Range	-55°C to +85°C
Body Material	Zinc
Body Plating	Nickel
Male Contact Material	Brass
Female Contact Material	Phosphor Bronze
Contact Plating	Gold
Insulation	Delrin or Polyethylene

TERMINATION TOOLING

Hand Tool	9-1478240-0
Die sets	9-147824X-0

For Tooling see customer drawings at www.tycoelectronics.com

FOR MORE INFORMATION

Technical Support

Internet: www.tycoelectronics.com
E-mail: newproducts@tycoelectronics.com
USA: 1-800-522-6752
Canada: 1-905-470-4425
Mexico: 52-55-1106-0800
C. America: 57-1-254-4444
South America: 55-11-2103-6000
Hong Kong: 852-2735-1628
Japan: 81-44-844-8013
UK: 44-208-420-8341

CONNECTORS WIRE & CABLE EMI/RFI FILTERS CIRCUIT BREAKERS HARNESSING & PROTECTION IDENTIFICATION & LABELING
CIRCUIT BREAKERS HARNESSING & PROTECTION IDENTIFICATION & LABELING PCB & CABLE ASSEMBLIES RELAYS TOOLING S
ION IDENTIFICATION & LABELING PCB & CABLE ASSEMBLIES RELAYS TOOLING SENSORS SWITCHES CONTACTORS CONNECT
ASSEMBLIES RELAYS TOOLING SENSORS SWITCHES CONTACTORS CONNECTORS WIRE & CABLE EMI/RFI FILTERS CIRCUIT
WITCHES CONTACTORS CONNECTORS WIRE & CABLE EMI/RFI FILTERS CIRCUIT BREAKERS HARNESSING & PROTECTION IDE
CABLE EMI/RFI FILTERS CIRCUIT BREAKERS HARNESSING & PROTECTION IDENTIFICATION & LABELING PCB & CABLE ASSEMB
HARNESSING & PROTECTION IDENTIFICATION & LABELING PCB & CABLE ASSEMBLIES RELAYS TOOLING SENSORS SWITCHES
LABELING PCB & CABLE ASSEMBLIES RELAYS TOOLING SENSORS SWITCHES CONTACTORS CONNECTORS WIRE & CABLE E
OOLING SENSORS SWITCHES CONTACTORS CONNECTORS WIRE & CABLE EMI/RFI FILTERS CIRCUIT BREAKERS HARNESSING
CONNECTORS WIRE & CABLE EMI/RFI FILTERS CIRCUIT BREAKERS HARNESSING & PROTECTION IDENTIFICATION & LABELING
CIRCUIT BREAKERS HARNESSING & PROTECTION IDENTIFICATION & LABELING PCB & CABLE ASSEMBLIES RELAYS TOOLING S
ION IDENTIFICATION & LABELING PCB & CABLE ASSEMBLIES RELAYS TOOLING SENSORS SWITCHES CONTACTORS CONNECT
ASSEMBLIES RELAYS TOOLING SENSORS SWITCHES CONTACTORS CONNECTORS WIRE & CABLE EMI/RFI FILTERS CIRCUIT
WITCHES CONTACTORS CONNECTORS WIRE & CABLE EMI/RFI FILTERS CIRCUIT BREAKERS HARNESSING & PROTECTION IDE
CABLE EMI/RFI FILTERS CIRCUIT BREAKERS HARNESSING & PROTECTION IDENTIFICATION & LABELING PCB & CABLE ASSEMB
HARNESSING & PROTECTION IDENTIFICATION & LABELING PCB & CABLE ASSEMBLIES RELAYS TOOLING SENSORS SWITCHES
LABELING PCB & CABLE ASSEMBLIES RELAYS TOOLING SENSORS SWITCHES CONTACTORS CONNECTORS WIRE & CABLE E
OOLING SENSORS SWITCHES CONTACTORS CONNECTORS WIRE & CABLE EMI/RFI FILTERS CIRCUIT BREAKERS HARNESSING

Tyco Electronics Corporation
Harrisburg, PA

tycoelectronics.com

©2007 Tyco Electronics Corporation. All rights reserved.
6-1773448-5-5M-MS/FP 10-07
TE Logo and Tyco Electronics are trademarks.



Mouser Electronics

Authorized Distributor

Click to View Pricing, Inventory, Delivery & Lifecycle Information:

[TE Connectivity:](#)

[1-1337494-0](#)