

3M™ Chip Carrier Sockets

Low Profile, Four-Row, Through Hole

8400 Series



- Accepts chip carriers conforming to JEDEC outline MO-047 for square and MO-052 for rectangular
- Compatible with automated loading equipment
- Open top design allows unrestricted air flow
- Molded slots for ease of device extraction
- Wave solder compatible. Not suitable for reflow soldering
- RoHS Compliant. See the Regulatory Information Appendix (RIA) in the "RoHS Compliance" section of www.3Mconnector.com for compliance information (RIA E1 and C1 apply)

Date Modified: September 14, 2011

TS-2148-B
Sheet 1 of 2

Physical

Insulation

Material: Glass Filled Polyester (PBT)

Flammability: UL 94V-0

Color: Black

Contact

Material: Copper Alloy

Plating

Underplating: 50 μ " [1.27 μ m] Nickel - Overall

Wiping Area: 160 μ " , [4.06 μ m] Matte Tin

Electrical

Contact Resistance: 15 m Ω

Insulation Resistance: >10³ M Ω minimum

Capacitance: <1 pF at 1 MHz

Environmental

Temperature Rating: -40°C to +105°C

Process Rating: Wave Solder Only

Notice:

Please be aware that the 3M PLCC products are tin plated on the contact wiping surface. This is necessary to ensure mated reliability since standard PLCC contacts are also tin plated. Since tin whiskers are an inherent characteristic of tin and mechanically stressing the tin is a known driver of whisker growth, it is possible the PLCC and PLCC socket may exhibit tin whisker growth after mating. 3M follows the iNEMI plating recommendations which include whisker mitigating tin plating chemistry to reduce the likelihood of tin whisker growth. Please consider whether a PLCC socket is suitable for your particular needs after considering your product applications life span and environment including mechanical stresses, humidity, and thermal cycling all of which have been shown to stimulate tin whisker growth.

3M

Electronic Solutions Division
Interconnect Solutions
<http://www.3Mconnectors.com>

3M is a trademark of 3M Company.
For technical, sales or ordering information call
800-225-5373

3M™ Chip Carrier Sockets

Low Profile, Four-Row, Through Hole

8400 Series

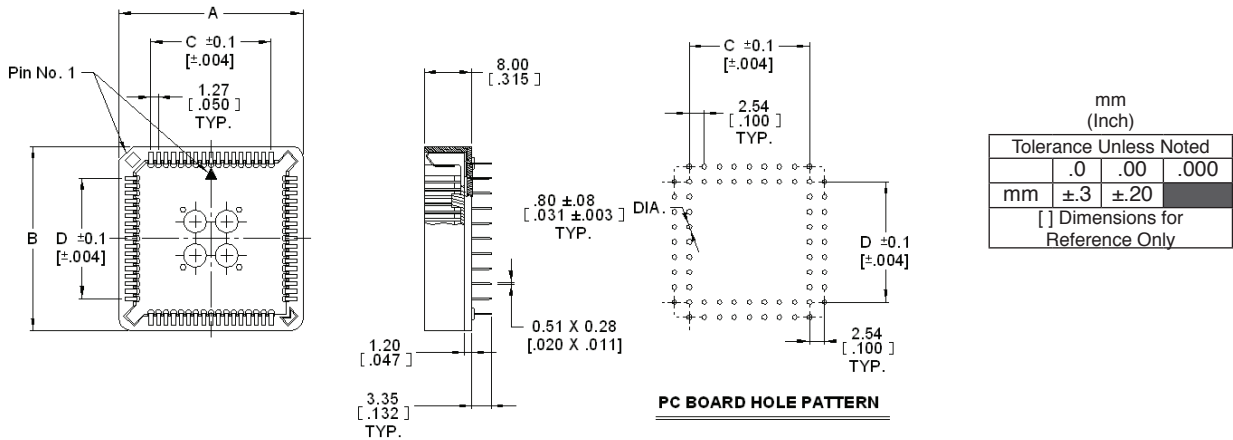

Contact Quantity	Part No.	A	B	C	D
20	8420-11B1-RK-TP	15.50 [0.611]	15.50 [0.611]	5.08 [0.200]	5.08 [0.200]
28	8428-11B1-RK-TP	18.05 [0.711]	18.05 [0.711]	7.62 [0.300]	7.62 [0.300]
32	8432-11B1-RK-TP	18.05 [0.711]	20.60 [0.812]	7.62 [0.300]	10.16 [0.400]
44	8444-11B1-RK-TP	23.50 [0.926]	23.50 [0.926]	12.70 [0.500]	12.70 [0.500]
52	8452-11B1-RK-TP	25.88 [1.020]	25.88 [1.020]	15.24 [0.600]	15.24 [0.600]
68	8468-11B1-RK-TP	31.05 [1.223]	31.05 [1.223]	20.32 [0.801]	20.32 [0.801]
84	8484-11B1-RK-TP	36.05 [1.420]	36.05 [1.420]	25.40 [1.001]	25.40 [1.001]

LAYOUT DIAGRAM

20 POSITION

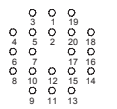

28 POSITION

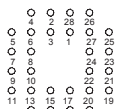

32 POSITION

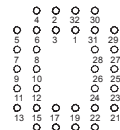

44 POSITION

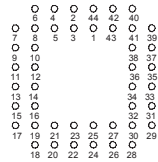

52 POSITION



64 POSITION

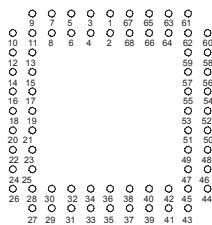

84 POSITION

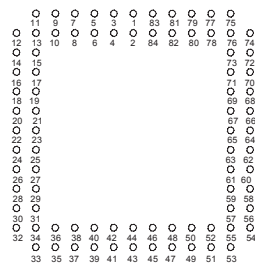

Ordering Information

84XX - 11B1 - RK - TP

└── Contact Quantity
(See Table)

Note: Parts packaged in tubes.

TS-2148-B
Sheet 2 of 2

Important Notice

All statements, technical information, and recommendations related to 3M's products are based on information believed to be reliable, but the accuracy or completeness is not guaranteed. Before using this product, you must evaluate it and determine if it is suitable for your intended application. You assume all risks and liability associated with such use. Any statements related to the product which are not contained in 3M's current publications, or any contrary statements contained on your purchase order shall have no force or effect unless expressly agreed upon, in writing, by an authorized officer of 3M.

Warranty; Limited Remedy; Limited Liability.

This product will be free from defects in material and manufacture for a period of ninety (90) days from the time of purchase. **3M MAKES NO OTHER WARRANTIES INCLUDING, BUT NOT LIMITED TO, ANY IMPLIED WARRANTY OF MERCHANTABILITY OR FITNESS FOR A PARTICULAR PURPOSE.** If this product is defective within the warranty period stated above, your exclusive remedy shall be, at 3M's option, to replace or repair the 3M product or refund the purchase price of the 3M product. **Except where prohibited by law, 3M will not be liable for any indirect, special, incidental or consequential loss or damage arising from this 3M product, regardless of the legal theory asserted.**

**3M Electronics Solutions Division**

6801 River Place Blvd.
Austin, TX 78726-9000
U.S.A.
1-800-225-5373
www.3Mconnector.com

Please recycle. Printed in USA.
© 3M 2010. All rights reserved.
RIA-2217B-E

3M is a trademark of 3M Company.

Mouser Electronics

Authorized Distributor

Click to View Pricing, Inventory, Delivery & Lifecycle Information:

[3M:](#)

[8420-11B1-RK-TP](#) [8452-11B1-RK-TP](#) [8428-11B1-RK-TP](#) [8468-11B1-RK-TP](#) [8444-11B1-RK-TP](#) [8432-11B1-RK-TP](#)
[8484-11B1-RK-TP](#)