

AUIRFR4615 AUIRFU4615

HEXFET® Power MOSFET

Features

- Advanced Process Technology
- Low On-Resistance
- 175°C Operating Temperature
- Fast Switching
- Repetitive Avalanche Allowed up to Tjmax
- Lead-Free, RoHS Compliant
- Automotive Qualified *

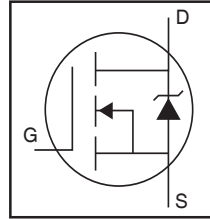

V_{DSS}		150V
$R_{DS(on)}$	typ.	34mΩ
	max.	42mΩ
I_D		33A

Description

Specifically designed for Automotive applications, this HEXFET® Power MOSFET utilizes the latest processing techniques to achieve extremely low on-resistance per silicon area. Additional features of this design are a 175°C junction operating temperature, fast switching speed and improved repetitive avalanche rating. These features combine to make this design an extremely efficient and reliable device for use in Automotive applications and a wide variety of other applications.

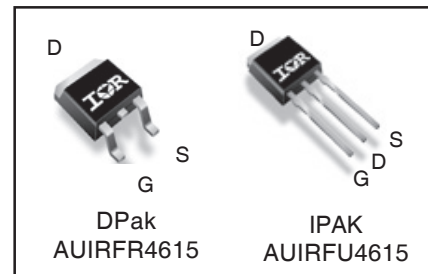

G	D	S
Gate	Drain	Source

Absolute Maximum Ratings

Stresses beyond those listed under “Absolute Maximum Ratings” may cause permanent damage to the device. These are stress ratings only; and functional operation of the device at these or any other condition beyond those indicated in the specifications is not implied. Exposure to absolute-maximum-rated conditions for extended periods may affect device reliability. The thermal resistance and power dissipation ratings are measured under board mounted and still air conditions. Ambient temperature (T_A) is 25°C, unless otherwise specified.

	Parameter	Max.	Units
$I_D @ T_C = 25^\circ\text{C}$	Continuous Drain Current, $V_{GS} @ 10\text{V}$	33	A
$I_D @ T_C = 100^\circ\text{C}$	Continuous Drain Current, $V_{GS} @ 10\text{V}$	24	
I_{DM}	Pulsed Drain Current ①	140	
$P_D @ T_C = 25^\circ\text{C}$	Maximum Power Dissipation	144	W
	Linear Derating Factor	0.96	W/°C
V_{GS}	Gate-to-Source Voltage	± 20	V
E_{AS} (Thermally limited)	Single Pulse Avalanche Energy ②	109	mJ
I_{AR}	Avalanche Current ①	See Fig. 14, 15, 22a, 22b,	A
E_{AR}	Repetitive Avalanche Energy ①		mJ
dv/dt	Peak Diode Recovery ③	38	V/ns
T_J	Operating Junction and	-55 to + 175	°C
T_{STG}	Storage Temperature Range		
	Soldering Temperature, for 10 seconds		

Thermal Resistance

	Parameter	Typ.	Max.	Units
$R_{\theta JC}$	Junction-to-Case ④	—	1.045	°C/W
$R_{\theta JA}$	Junction-to-Ambient (PCB Mount) ⑦	—	50	
$R_{\theta JA}$	Junction-to-Ambient	—	110	

HEXFET® is a registered trademark of International Rectifier.

*Qualification standards can be found at <http://www.irf.com/>

Static Electrical Characteristics @ T_J = 25°C (unless otherwise specified)

	Parameter	Min.	Typ.	Max.	Units	Conditions
V _{(BR)DSS}	Drain-to-Source Breakdown Voltage	150	—	—	V	V _{GS} = 0V, I _D = 250μA
ΔV _{(BR)DSS} /ΔT _J	Breakdown Voltage Temp. Coefficient	—	0.19	—	V/°C	Reference to 25°C, I _D = 5mA ^①
R _{DS(on)}	Static Drain-to-Source On-Resistance	—	34	42	mΩ	V _{GS} = 10V, I _D = 21A ^④
V _{GS(th)}	Gate Threshold Voltage	3.0	—	5.0	V	V _{DS} = V _{GS} , I _D = 100μA
gfs	Forward Transconductance	35	—	—	S	V _{DS} = 50V, I _D = 21A
I _{DSS}	Drain-to-Source Leakage Current	—	—	20	μA	V _{DS} = 150V, V _{GS} = 0V
		—	—	250		V _{DS} = 150V, V _{GS} = 0V, T _J = 125°C
I _{GSS}	Gate-to-Source Forward Leakage	—	—	100	nA	V _{GS} = 20V
	Gate-to-Source Reverse Leakage	—	—	-100		V _{GS} = -20V
R _{G(int)}	Internal Gate Resistance	—	2.7	—	Ω	

Dynamic @ T_J = 25°C (unless otherwise specified)

	Parameter	Min.	Typ.	Max.	Units	Conditions
Q _g	Total Gate Charge	—	26	—	nC	I _D = 21A V _{DS} = 75V V _{GS} = 10V ^④
Q _{gs}	Gate-to-Source Charge	—	8.6	—		
Q _{gd}	Gate-to-Drain ("Miller") Charge	—	9.0	—		
Q _{sync}	Total Gate Charge Sync. (Q _g - Q _{gd})	—	17	—		
t _{d(on)}	Turn-On Delay Time	—	15	—	ns	V _{DD} = 98V I _D = 21A R _G = 7.3Ω V _{GS} = 10V ^④
t _r	Rise Time	—	35	—		
t _{d(off)}	Turn-Off Delay Time	—	25	—		
t _f	Fall Time	—	20	—		
C _{iss}	Input Capacitance	—	1750	—	pF	V _{GS} = 0V V _{DS} = 50V f = 1.0MHz (See Fig.5) V _{GS} = 0V, V _{DS} = 0V to 120V ^⑥ (See Fig.11) V _{GS} = 0V, V _{DS} = 0V to 120V ^⑤
C _{oss}	Output Capacitance	—	155	—		
C _{rss}	Reverse Transfer Capacitance	—	40	—		
C _{oss eff. (ER)}	Effective Output Capacitance (Energy Related)	—	179	—		
C _{oss eff. (TR)}	Effective Output Capacitance (Time Related)	—	382	—		

Diode Characteristics

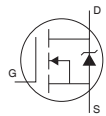
	Parameter	Min.	Typ.	Max.	Units	Conditions
I _S	Continuous Source Current (Body Diode)	—	—	33	A	MOSFET symbol showing the integral reverse p-n junction diode. 
I _{SM}	Pulsed Source Current (Body Diode) ^①	—	—	140		
V _{SD}	Diode Forward Voltage	—	—	1.3	V	T _J = 25°C, I _S = 21A, V _{GS} = 0V ^④
t _{rr}	Reverse Recovery Time	—	70	—	ns	T _J = 25°C V _R = 100V, T _J = 125°C I _F = 21A
Q _{rr}	Reverse Recovery Charge	—	177	—		
		—	247	—		
I _{RRM}	Reverse Recovery Current	—	4.9	—	A	T _J = 25°C
t _{on}	Forward Turn-On Time	Intrinsic turn-on time is negligible (turn-on is dominated by LS+LD)				

Notes:

- ① Repetitive rating; pulse width limited by max. junction temperature.
- ② Limited by T_{Jmax}, starting T_J = 25°C, L = 0.51mH
R_G = 25Ω, I_{AS} = 21A, V_{GS} = 10V. Part not recommended for use above this value.
- ③ I_{SD} ≤ 21A, di/dt ≤ 549A/μs, V_{DD} ≤ V_{(BR)DSS}, T_J ≤ 175°C.
- ④ Pulse width ≤ 400μs; duty cycle ≤ 2%.
- ⑤ C_{oss eff. (TR)} is a fixed capacitance that gives the same charging time as C_{oss} while V_{DS} is rising from 0 to 80% V_{DSS}.
- ⑥ C_{oss eff. (ER)} is a fixed capacitance that gives the same energy as C_{oss} while V_{DS} is rising from 0 to 80% V_{DSS}.
- ⑦ When mounted on 1" square PCB (FR-4 or G-10 Material). For recommended footprint and soldering techniques refer to application note #AN-994
- ⑧ R_θ is measured at T_J approximately 90°C

Qualification Information[†]

Qualification Level		Automotive (per AEC-Q101) ^{††}	
		Comments: This part number(s) passed Automotive qualification. IR's Industrial and Consumer qualification level is granted by extension of the higher Automotive level.	
Moisture Sensitivity Level		D PAK	MSL1
		I-PAK	N/A
ESD	Machine Model	Class M3(+/- 400V) ^{†††} AEC-Q101-002	
	Human Body Model	Class H1B(+/- 1000V) ^{†††} AEC-Q101-001	
	Charged Device Model	Class C5(+/- 2000V) ^{†††} AEC-Q101-005	
RoHS Compliant		Yes	

† Qualification standards can be found at International Rectifier's web site: <http://www.irf.com/>

†† Exceptions (if any) to AEC-Q101 requirements are noted in the qualification report.

††† Highest passing voltage

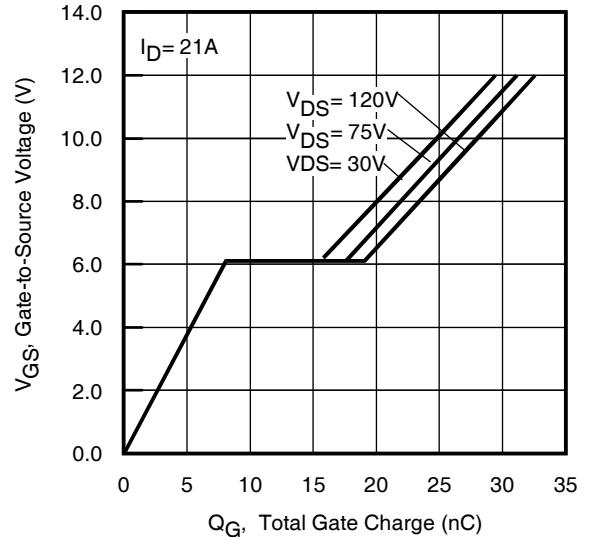
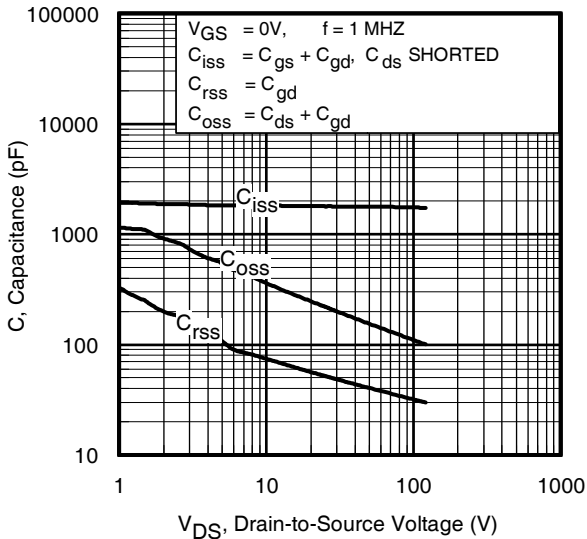
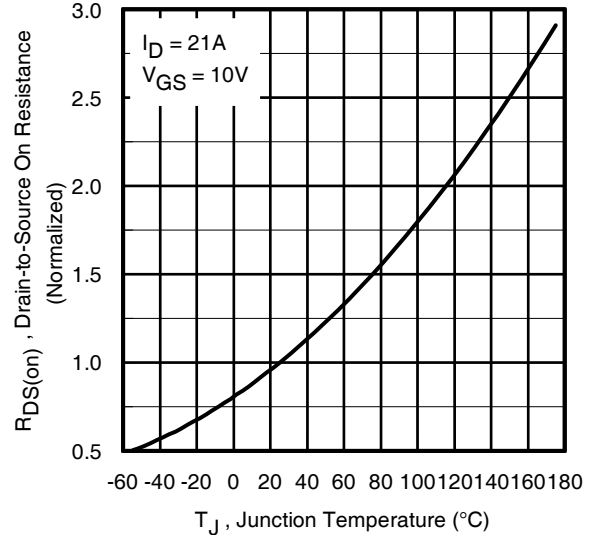
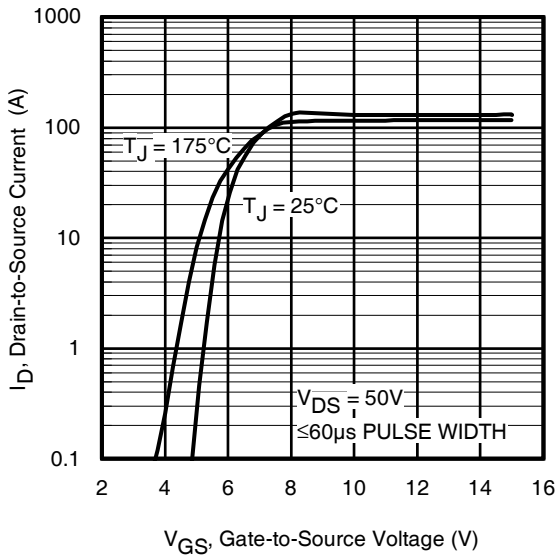
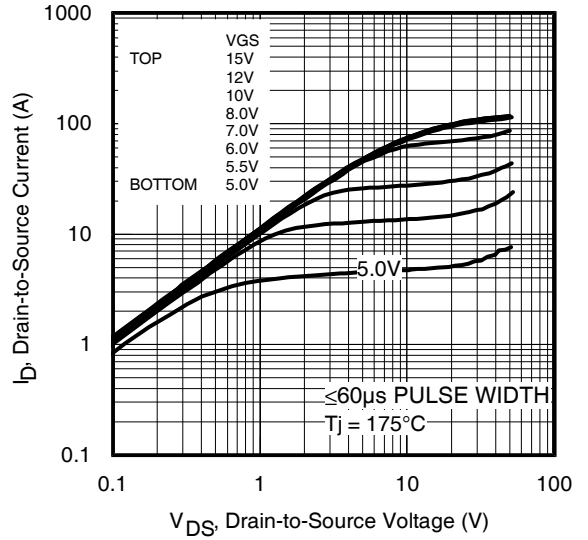
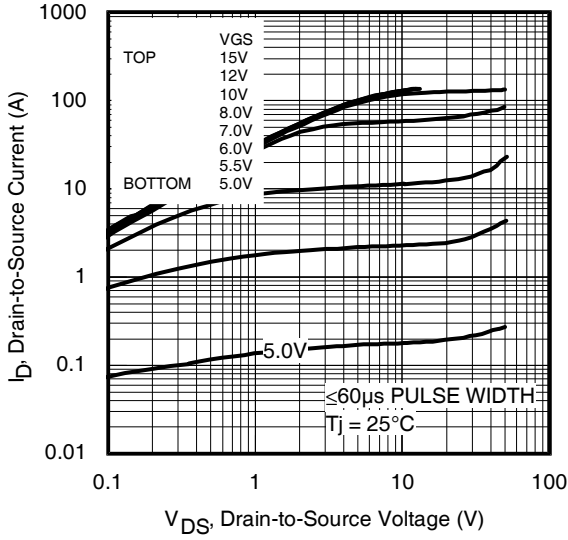

Fig 5. Typical Capacitance vs. Drain-to-Source Voltage

Fig 6. Typical Gate Charge vs. Gate-to-Source Voltage

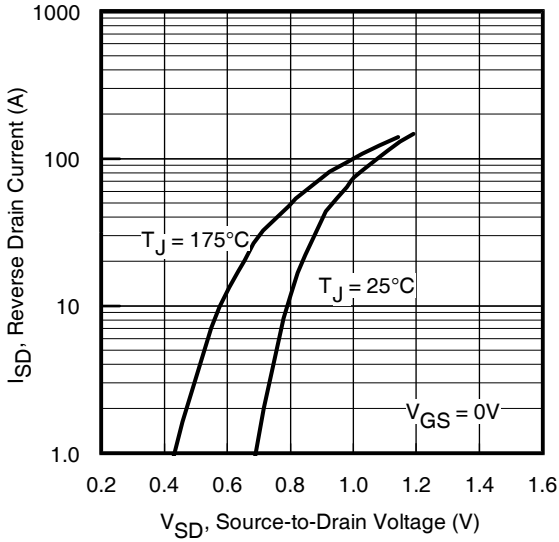

Fig 7. Typical Source-Drain Diode Forward Voltage

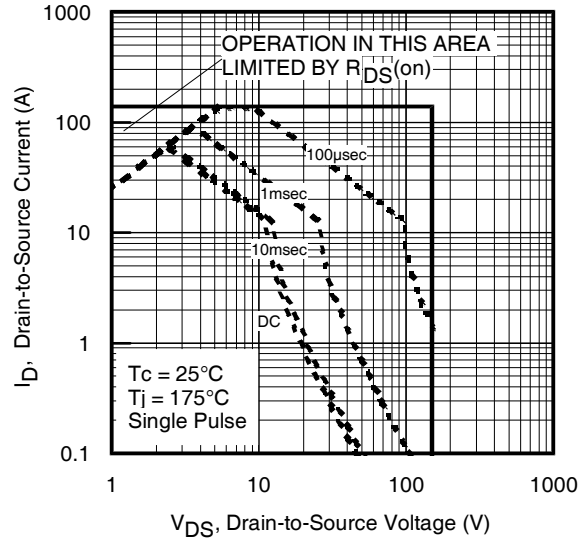

Fig 8. Maximum Safe Operating Area

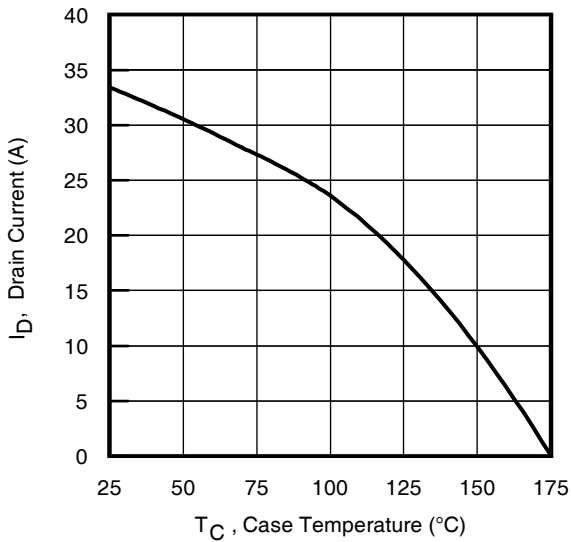

Fig 9. Maximum Drain Current vs. Case Temperature

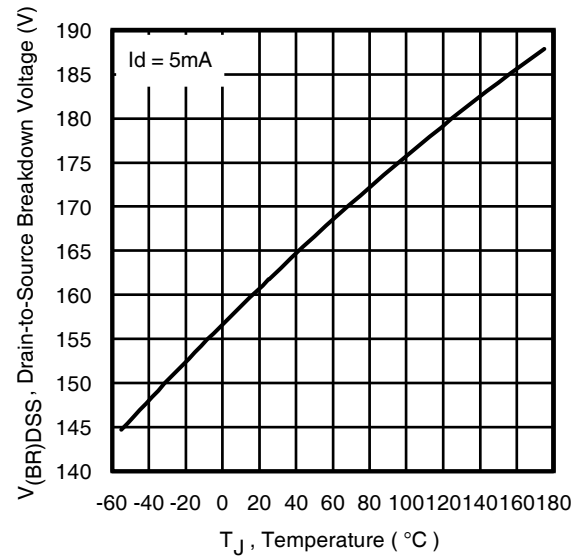

Fig 10. Drain-to-Source Breakdown Voltage

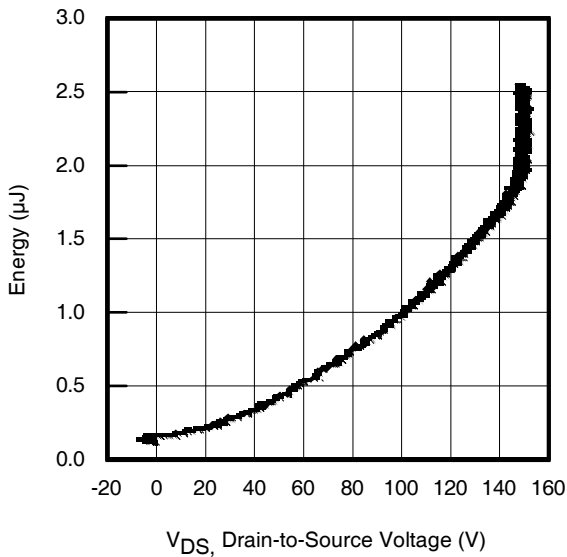

Fig 11. Typical C_{OSS} Stored Energy

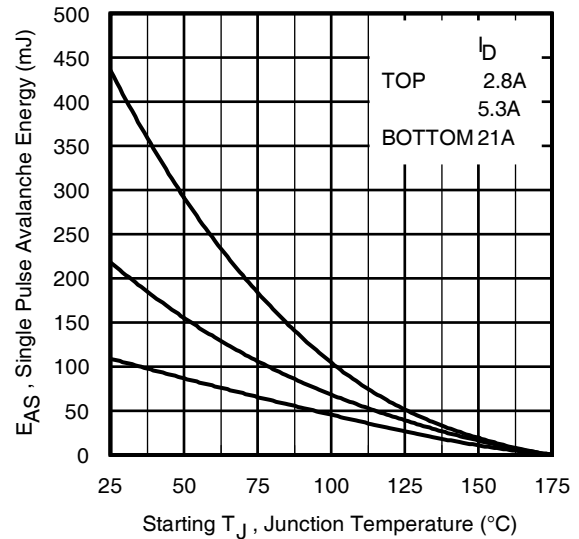

Fig 12. Maximum Avalanche Energy vs. Drain Current

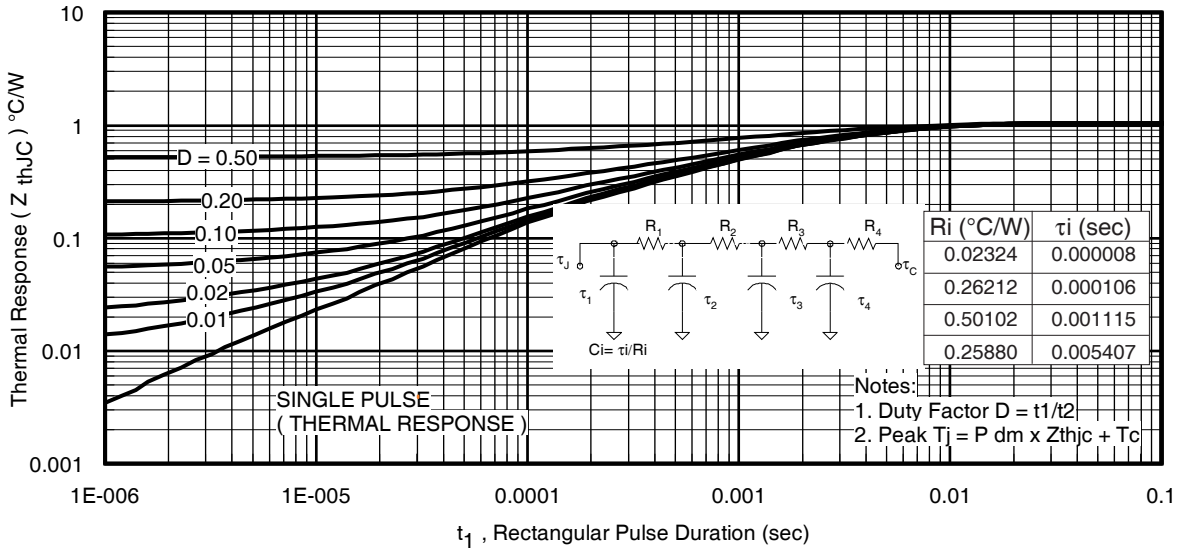

Fig 13. Maximum Effective Transient Thermal Impedance, Junction-to-Case

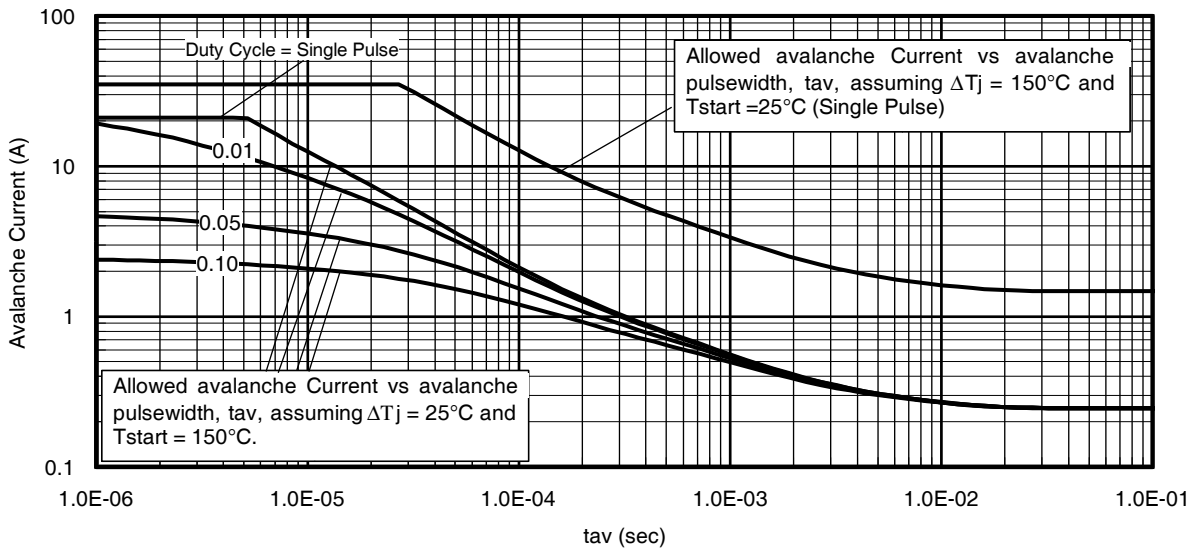
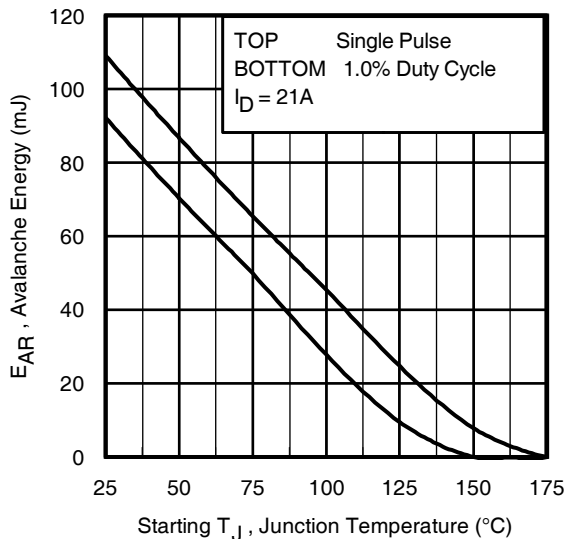

Fig 14. Typical Avalanche Current vs. Pulsewidth



Notes on Repetitive Avalanche Curves , Figures 14, 15:
 (For further info, see AN-1005 at www.irf.com)

1. Avalanche failures assumption:
Purely a thermal phenomenon and failure occurs at a temperature far in excess of T_{jmax} . This is validated for every part type.
2. Safe operation in Avalanche is allowed as long as T_{jmax} is not exceeded.
3. Equation below based on circuit and waveforms shown in Figures 22a,22b.
4. $P_{D(ave)}$ = Average power dissipation per single avalanche pulse.
5. BV = Rated breakdown voltage (1.3 factor accounts for voltage increase during avalanche).
6. I_{av} = Allowable avalanche current.
7. ΔT = Allowable rise in junction temperature, not to exceed T_{jmax} (assumed as 25°C in Figure 14, 15).
 t_{av} = Average time in avalanche.
 D = Duty cycle in avalanche = $t_{av} \cdot f$
 $Z_{thJC}(D, t_{av})$ = Transient thermal resistance, see Figures 13)

$$P_{D(ave)} = 1/2 (1.3 \cdot BV \cdot I_{av}) = \Delta T / Z_{thJC}$$

$$I_{av} = 2\Delta T / [1.3 \cdot BV \cdot Z_{th}]$$

$$E_{AS(AR)} = P_{D(ave)} \cdot t_{av}$$

Fig 15. Maximum Avalanche Energy vs. Temperature

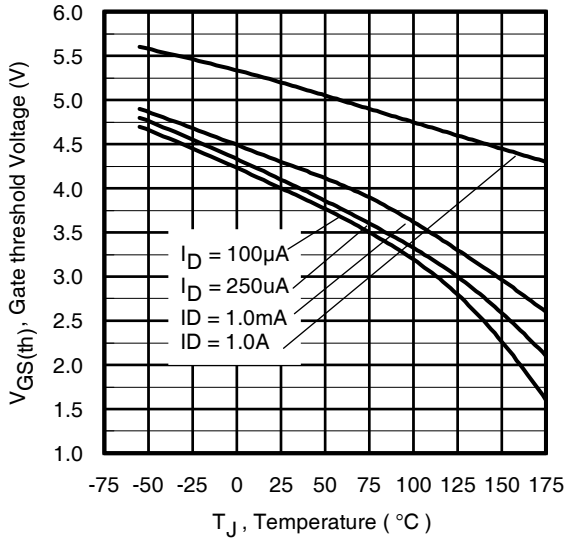

Fig. 16. Threshold Voltage vs. Temperature

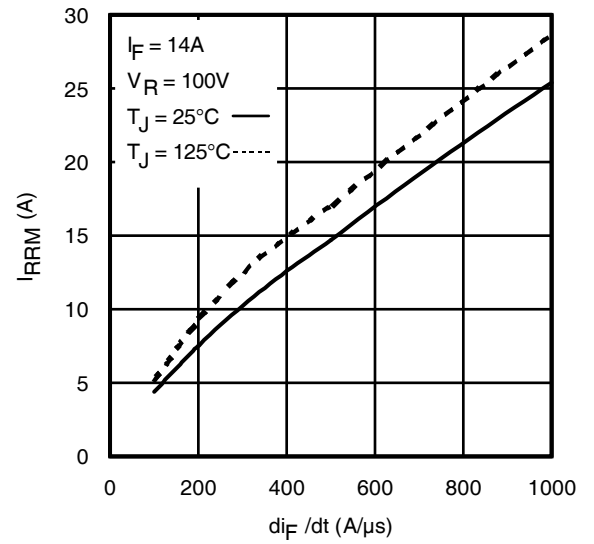

Fig. 17 - Typical Recovery Current vs. di_F/dt

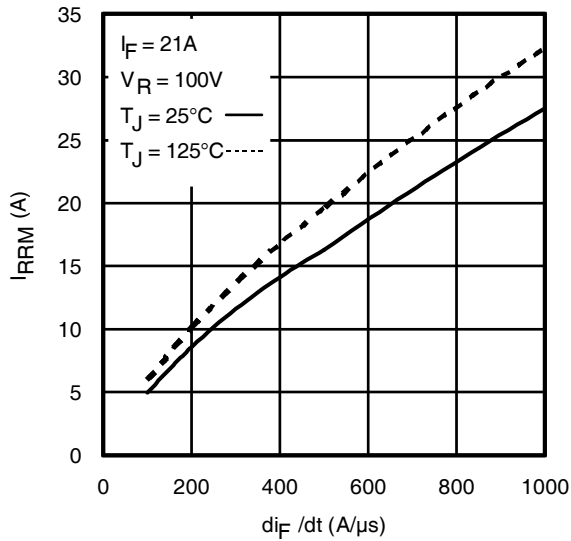

Fig. 18 - Typical Recovery Current vs. di_F/dt

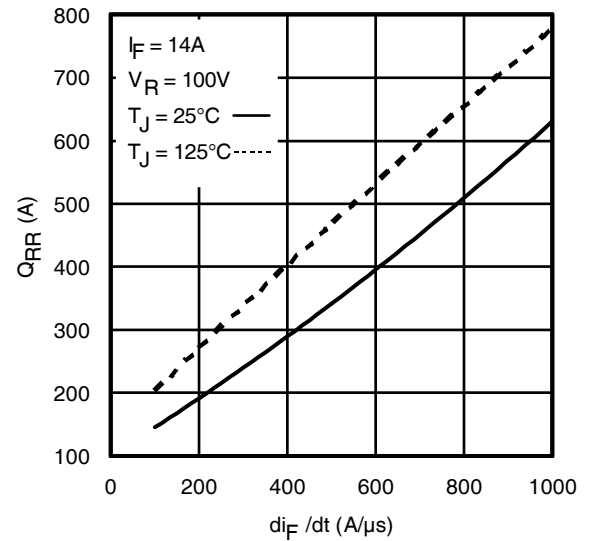

Fig. 19 - Typical Stored Charge vs. di_F/dt

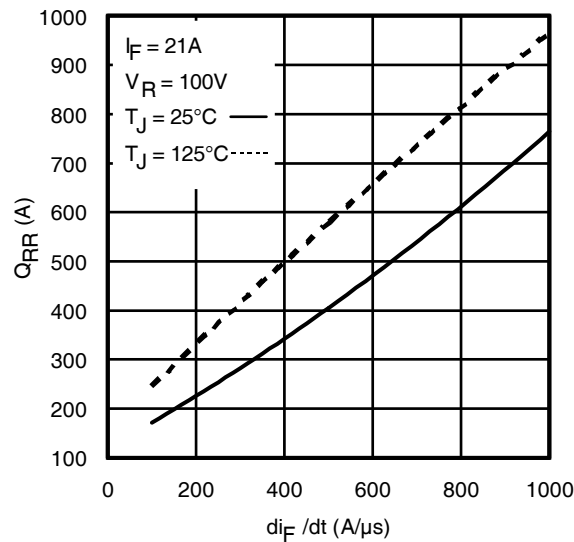
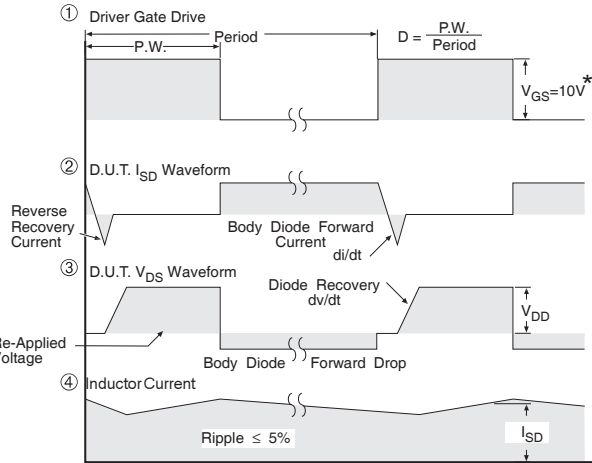
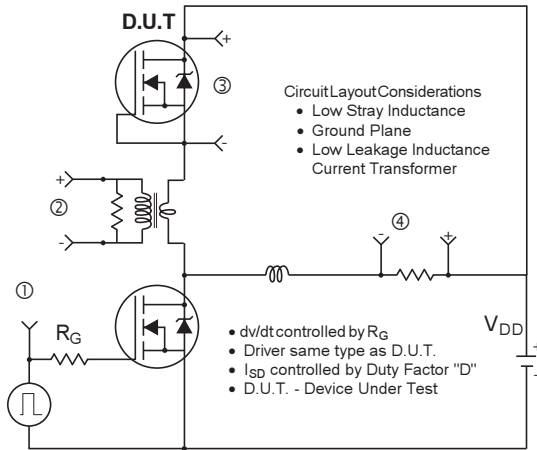

Fig. 20 - Typical Stored Charge vs. di_F/dt



* $V_{GS} = 5V$ for Logic Level Devices

Fig 21. Peak Diode Recovery dv/dt Test Circuit for N-Channel HEXFET® Power MOSFETs

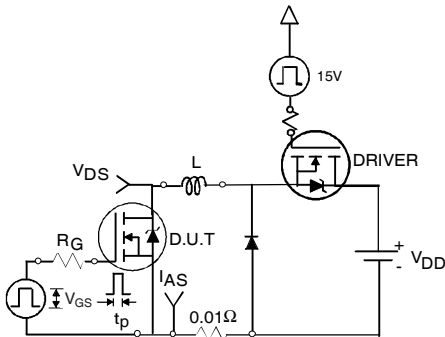

Fig 22a. Unclamped Inductive Test Circuit



Fig 22b. Unclamped Inductive Waveforms

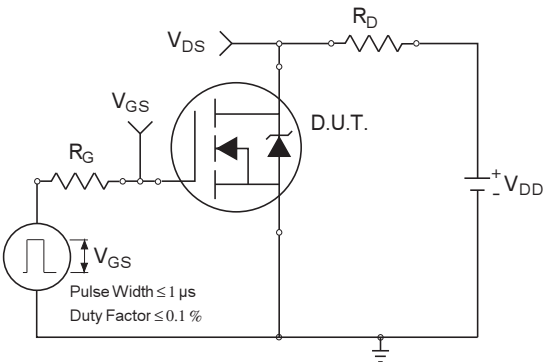

Fig 23a. Switching Time Test Circuit

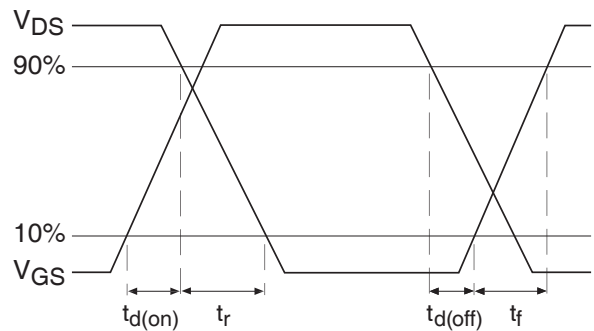

Fig 23b. Switching Time Waveforms

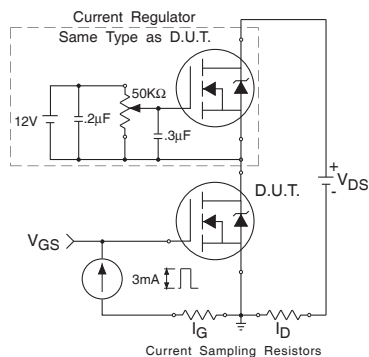

Fig 24a. Gate Charge Test Circuit

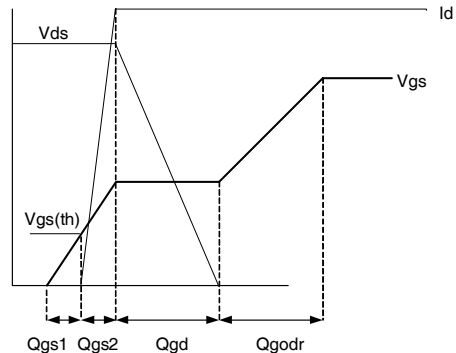
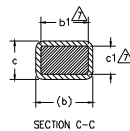
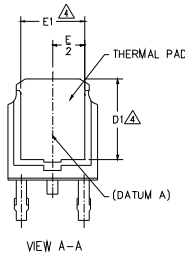
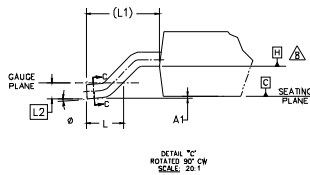
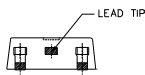
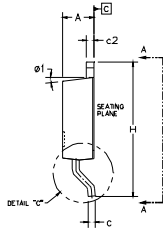
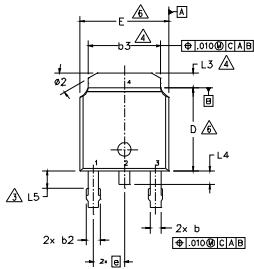

Fig 24b. Gate Charge Waveform

D-Pak (TO-252AA) Package Outline

Dimensions are shown in millimeters (inches)



NOTES:

- 1.- DIMENSIONING AND TOLERANCING PER ASME Y14.5M-1994
- 2.- DIMENSION ARE SHOWN IN INCHES [MILLIMETERS]
- 3.- LEAD DIMENSION UNCONTROLLED IN L5.
- 4.- DIMENSION D1, E1, L3 & b3 ESTABLISH A MINIMUM MOUNTING SURFACE FOR THERMAL PAD.
- 5.- SECTION C-C DIMENSIONS APPLY TO THE FLAT SECTION OF THE LEAD BETWEEN .005 AND 0.10 [0.13 AND 0.25] FROM THE LEAD TIP.
- 6.- DIMENSION D & E DO NOT INCLUDE MOLD FLASH. MOLD FLASH SHALL NOT EXCEED .005 [0.13] PER SIDE. THESE DIMENSIONS ARE MEASURED AT THE OUTMOST EXTREMES OF THE PLASTIC BODY.
- 7.- DIMENSION b1 & c1 APPLIED TO BASE METAL ONLY.
- 8.- DATUM A & B TO BE DETERMINED AT DATUM PLANE H.
- 9.- OUTLINE CONFORMS TO JEDEC OUTLINE TO-252AA.

SYMBOL	DIMENSIONS				NOTES
	MILLIMETERS		INCHES		
	MIN.	MAX.	MIN.	MAX.	
A	2.18	2.39	.086	.094	
A1	-	0.13	-	.005	
b	0.64	0.89	.025	.035	
b1	0.65	0.79	.025	.031	7
b2	0.76	1.14	.030	.045	
b3	4.95	5.46	.195	.215	4
c	0.46	0.61	.018	.024	
c1	0.41	0.56	.016	.022	7
c2	0.46	0.89	.018	.035	
D	5.97	6.22	.235	.245	6
D1	5.21	-	.205	-	4
E	6.35	6.73	.250	.265	6
E1	4.32	-	.170	-	4
e	2.29 BSC		.090 BSC		
H	9.40	10.41	.370	.410	
L	1.40	1.78	.055	.070	
L1	2.74 BSC		.108 REF.		
L2	0.51 BSC		.020 BSC		
L3	0.89	1.27	.035	.050	4
L4	-	1.02	-	.040	
L5	1.14	1.52	.045	.060	3
ø	0"	10"	0"	10"	
ø1	0"	15"	0"	15"	
ø2	25"	35"	25"	35"	

LEAD ASSIGNMENTS

HEXFET

- 1.- GATE
- 2.- DRAIN
- 3.- SOURCE
- 4.- DRAIN

IGBT & CoPAK

- 1.- GATE
- 2.- COLLECTOR
- 3.- EMITTER
- 4.- COLLECTOR

D-Pak (TO-252AA) Part Marking Information

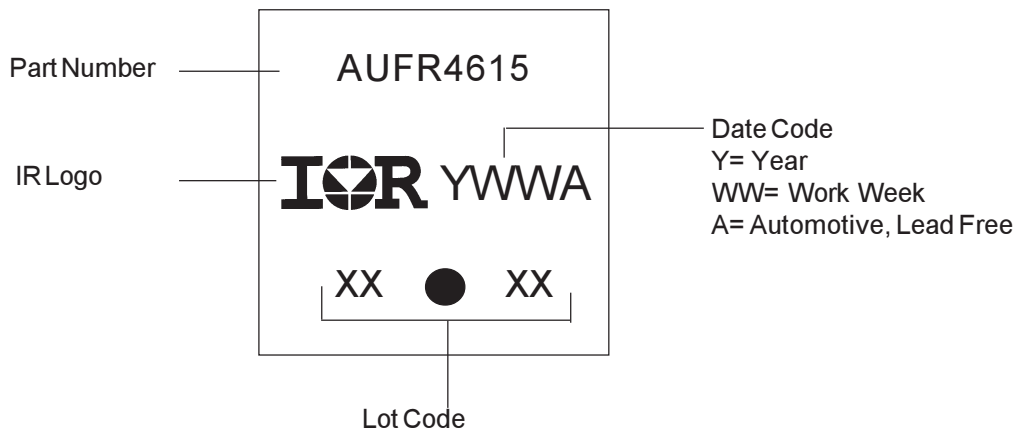

Note: For the most current drawing please refer to IR website at <http://www.irf.com/package/>

D-Pak (TO-252AA) Tape & Reel Information

Dimensions are shown in millimeters (inches)

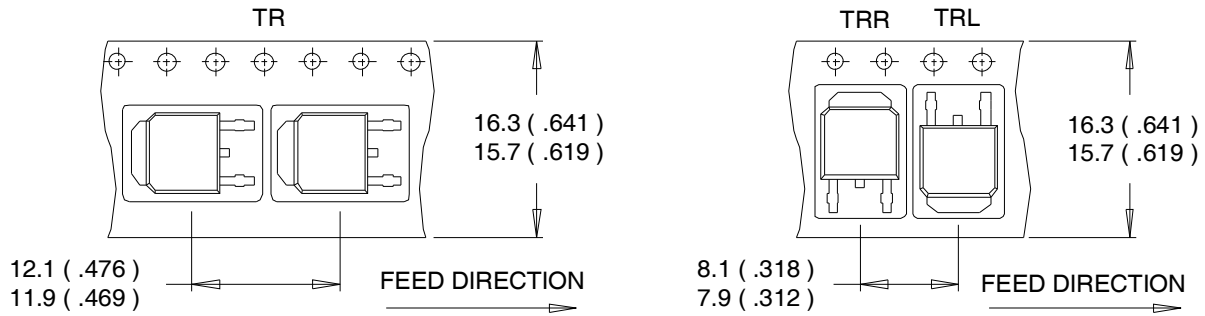

NOTES :

1. CONTROLLING DIMENSION : MILLIMETER.
2. ALL DIMENSIONS ARE SHOWN IN MILLIMETERS (INCHES).
3. OUTLINE CONFORMS TO EIA-481 & EIA-541.

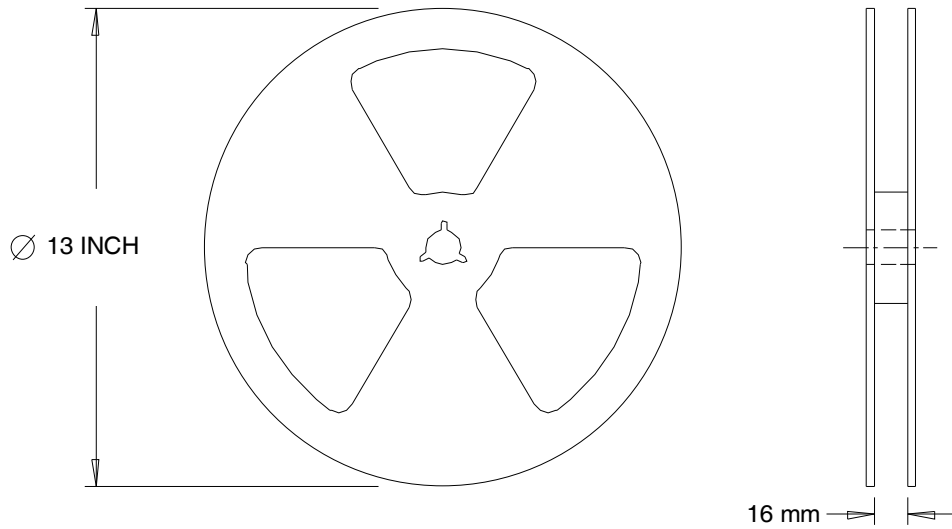

NOTES :

1. OUTLINE CONFORMS TO EIA-481.

Ordering Information

Base part	Package Type	Standard Pack		Complete Part Number
		Form	Quantity	
AUIRFR4615	DPak	Tube	75	AUIRFR4615
		Tape and Reel	2000	AUIRFR4615TR
		Tape and Reel Left	3000	AUIRFR4615TRL
		Tape and Reel Right	3000	AUIRFR4615TRR
AUIRFU4615	IPak	Tube	75	AUIRFU4615

IMPORTANT NOTICE

Unless specifically designated for the automotive market, International Rectifier Corporation and its subsidiaries (IR) reserve the right to make corrections, modifications, enhancements, improvements, and other changes to its products and services at any time and to discontinue any product or services without notice. Part numbers designated with the "AU" prefix follow automotive industry and / or customer specific requirements with regards to product discontinuance and process change notification. All products are sold subject to IR's terms and conditions of sale supplied at the time of order acknowledgment.

IR warrants performance of its hardware products to the specifications applicable at the time of sale in accordance with IR's standard warranty. Testing and other quality control techniques are used to the extent IR deems necessary to support this warranty. Except where mandated by government requirements, testing of all parameters of each product is not necessarily performed.

IR assumes no liability for applications assistance or customer product design. Customers are responsible for their products and applications using IR components. To minimize the risks with customer products and applications, customers should provide adequate design and operating safeguards.

Reproduction of IR information in IR data books or data sheets is permissible only if reproduction is without alteration and is accompanied by all associated warranties, conditions, limitations, and notices. Reproduction of this information with alterations is an unfair and deceptive business practice. IR is not responsible or liable for such altered documentation. Information of third parties may be subject to additional restrictions.

Resale of IR products or serviced with statements different from or beyond the parameters stated by IR for that product or service voids all express and any implied warranties for the associated IR product or service and is an unfair and deceptive business practice. IR is not responsible or liable for any such statements.

IR products are not designed, intended, or authorized for use as components in systems intended for surgical implant into the body, or in other applications intended to support or sustain life, or in any other application in which the failure of the IR product could create a situation where personal injury or death may occur. Should Buyer purchase or use IR products for any such unintended or unauthorized application, Buyer shall indemnify and hold International Rectifier and its officers, employees, subsidiaries, affiliates, and distributors harmless against all claims, costs, damages, and expenses, and reasonable attorney fees arising out of, directly or indirectly, any claim of personal injury or death associated with such unintended or unauthorized use, even if such claim alleges that IR was negligent regarding the design or manufacture of the product.

Only products certified as military grade by the Defense Logistics Agency (DLA) of the US Department of Defense, are designed and manufactured to meet DLA military specifications required by certain military, aerospace or other applications. Buyers acknowledge and agree that any use of IR products not certified by DLA as military-grade, in applications requiring military grade products, is solely at the Buyer's own risk and that they are solely responsible for compliance with all legal and regulatory requirements in connection with such use.

IR products are neither designed nor intended for use in automotive applications or environments unless the specific IR products are designated by IR as compliant with ISO/TS 16949 requirements and bear a part number including the designation "AU". Buyers acknowledge and agree that, if they use any non-designated products in automotive applications, IR will not be responsible for any failure to meet such requirements.

For technical support, please contact IR's Technical Assistance Center

<http://www.irf.com/technical-info/>

WORLDHEADQUARTERS:

101 N. Sepulveda Blvd., El Segundo, California 90245

Tel: (310) 252-7105

Mouser Electronics

Authorized Distributor

Click to View Pricing, Inventory, Delivery & Lifecycle Information:

[Infineon:](#)

[AUIRFR4615](#) [AUIRFR4615TR](#) [AUIRFR4615TRL](#) [AUIRFR4615TRR](#)