

PART NAME

NEMA 4X ENCLOSURE

PART No.

PN-1331, PN-1331-C AND PN-1331-DG

REV. DATE

11-17-08

INDUSTRY STANDARDS:

- POLYCARBONATE (LIGHT GRAY AND CLEAR)
- UL94-HB FLAMMABILITY RATING (UL FILE #E41613)
- UV STABILIZED
- SERVICE TEMPERATURE RANGE: -40°C TO +120°C
- ABS (DARK GRAY)
- UL94-HB FLAMMABILITY RATING (UL FILE #E56070)
- SERVICE TEMPERATURE RANGE: -40°C TO +80°C

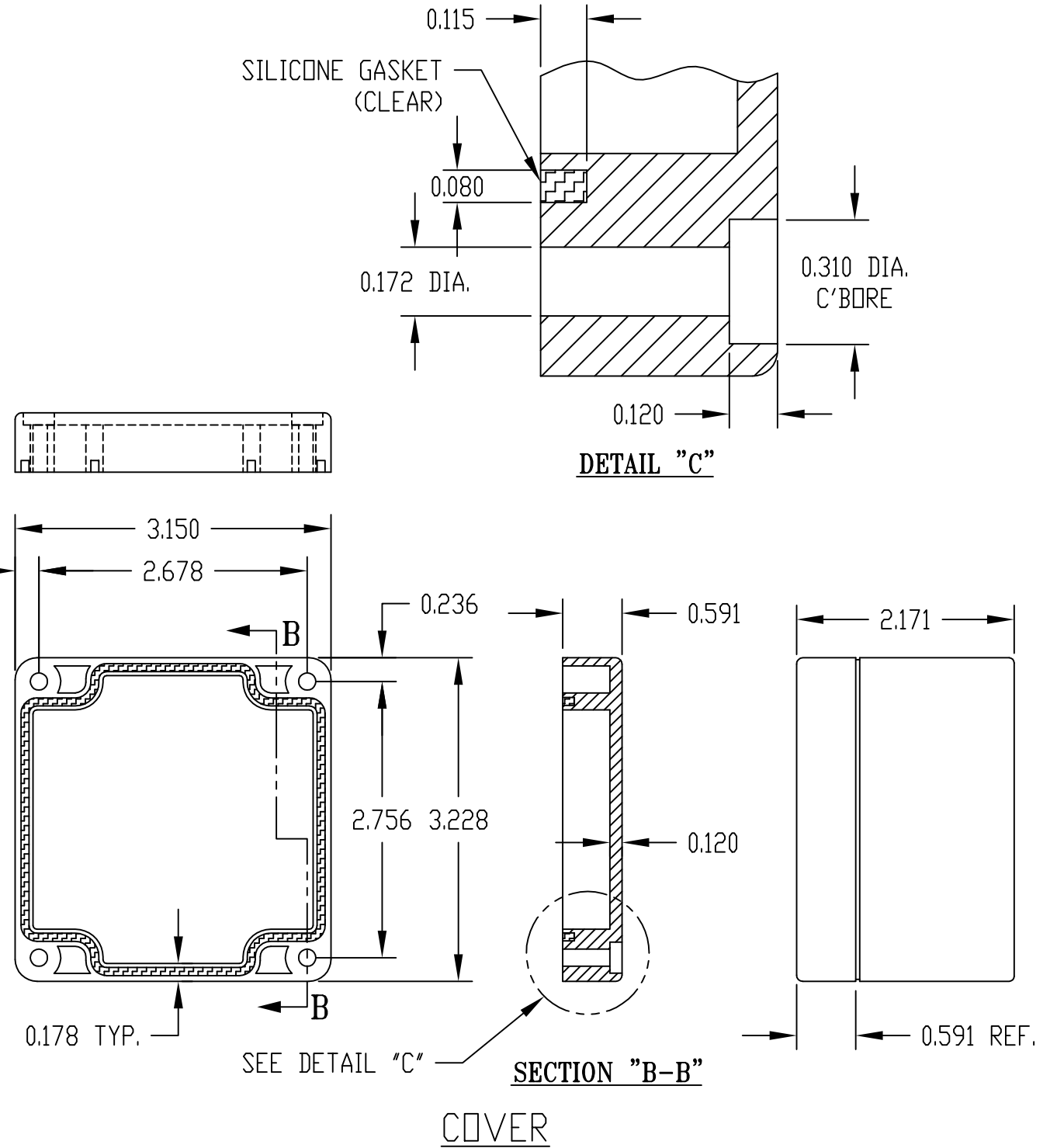
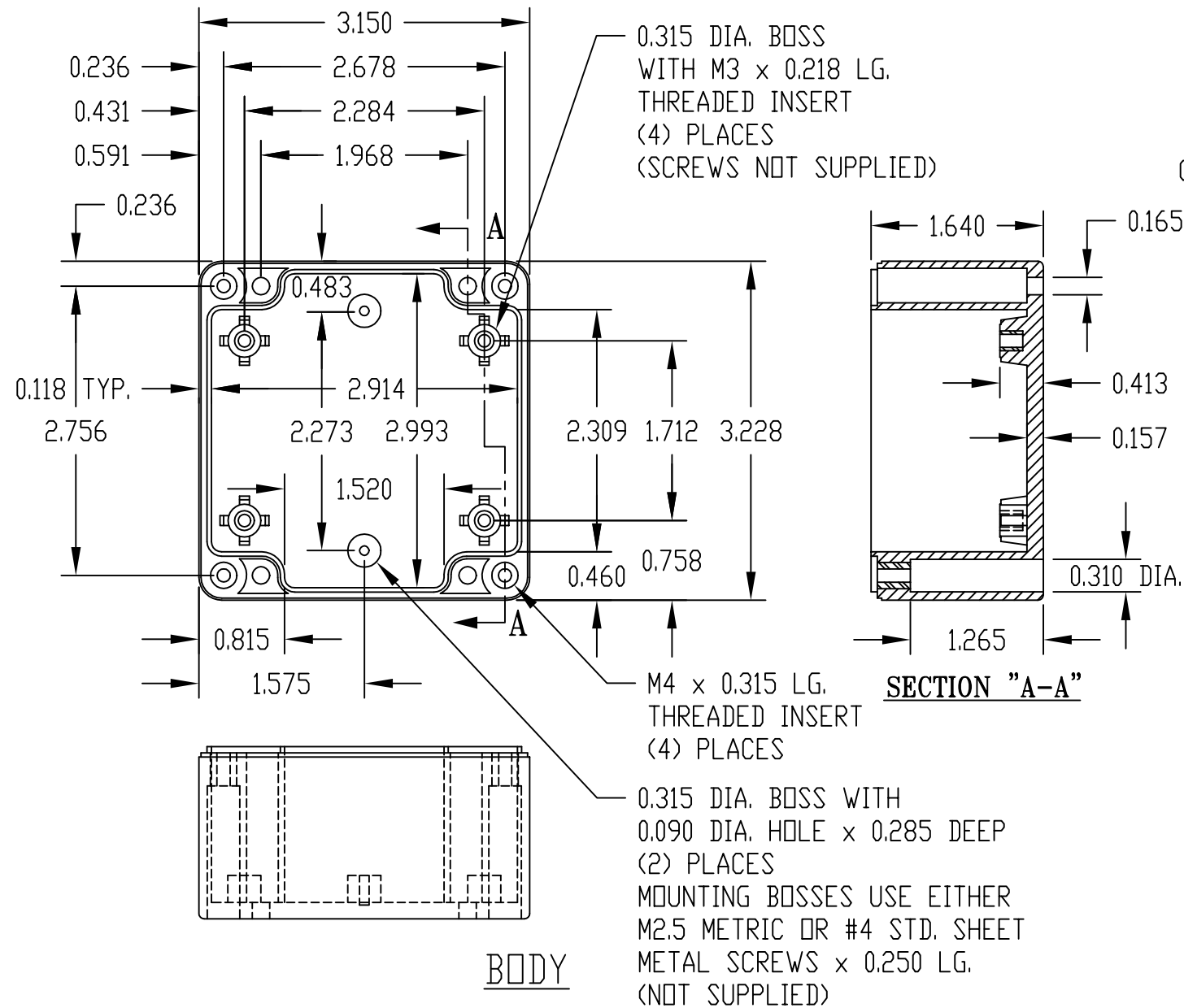

NOTE: ALL DIMENSIONS HAVE ±0.015 TOLERANCE UNLESS OTHERWISE SPECIFIED.

PART NUMBER	MATERIAL		FINISH		HARDWARE KIT
	BODY	COVER	BODY	COVER	
PN-1331	POLYCARBONATE		LIGHT GRAY		KIT CONTAINS (4) M4 x 20mm (0.787") LG. SCREWS FOR ASSEMBLY
PN-1331-C	POLYCARBONATE		LIGHT GRAY	CLEAR	
PN-1331-DG	HIGH-IMPACT ABS		DARK GRAY		

Mouser Electronics

Authorized Distributor

Click to View Pricing, Inventory, Delivery & Lifecycle Information:

[Bud Industries:](#)

[PN-1331-C](#) [PN-1331-DG](#) [PN-1331](#)