

LOC	DIST	REVISIONS				
P	LTR	DESCRIPTION	DATE	DWN	APVD	
E	B	BA	NEW RELEASE	23APR2010	PT	St.P

FOR FURTHER INFORMATION SEE DATA SHEET FOR
RP73 SERIES-SMD HIGH POWER PRECISION RESISTORS

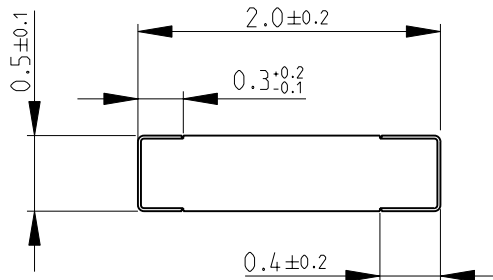

RoHS Compliant

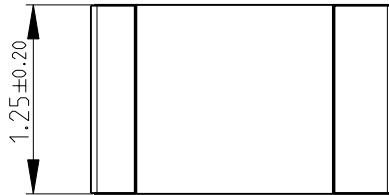
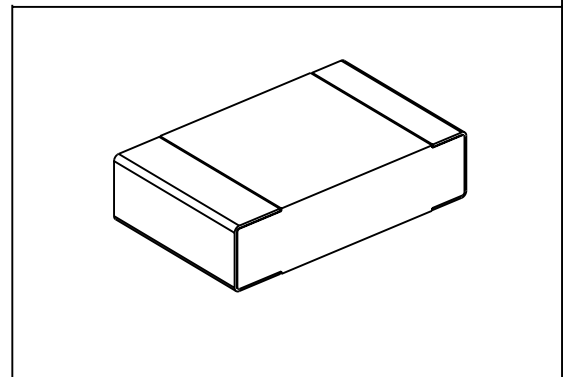

2008

RELEASED FOR PUBLICATION

THIS DRAWING IS UNPUBLISHED.

© COPYRIGHT 2008 BY TYCO ELECTRONICS CORPORATION. ALL RIGHTS RESERVED.

DIMENSIONS: mm	DWN PARUSURAM.T	23APR2010	MATERIAL	-	FINISH	-
	CHK SUBHASH.M	23APR2010	Tyco Electronics Corporation Dorcan, Swindon, SN3 5HH			
TOLERANCES UNLESS OTHERWISE SPECIFIED:	APVD STEPHEN.P	23APR2010				
0 PLC ±0.2	PRODUCT SPEC	-	NAME SMD HIGH POWER PRECISION RESISTORS SERIES RP73 - 2A			
1 PLC ±0.1	APPLICATION SPEC	-				
2 PLC ±-	WEIGHT	-	SIZE	CAGE CODE	DRAWING NO	RESTRICTED TO
3 PLC ±-			A 4	00779	© = 1625868	-
4 PLC ±-			CUSTOMER DRAWING			
ANGLES ±5°			SCALE	20:1	SHEET	1 OF 1
						REV BA

Mouser Electronics

Authorized Distributor

Click to View Pricing, Inventory, Delivery & Lifecycle Information:

[TE Connectivity:](#)

[9-1625868-0](#)