

FP1208

High frequency, high current power inductors

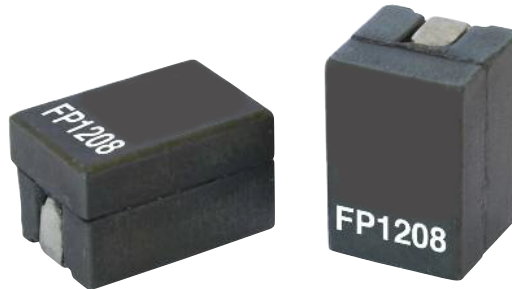

Product features

- 12.1x8.0x8.0mm maximum surface mount package
- Ferrite core material
- Controlled DCR for sensing circuits
- Inductance range from 150nH to 250nH
- Current range from 44 to 85 Amps
- Halogen free, lead free, RoHS compliant

Applications

- Multi-phase regulators
- Voltage Regulator Modules (VRMs)
- Desktop and server VRMs and EVRDs
- Data networking and storage systems
- Graphics cards and battery power systems
- Point-of-Load modules
- DCR Sensing circuits

Environmental data

- Storage temperature range (component):
-40 °C to +125 °C
- Operating temperature range: -40 °C to +125 °C
(ambient plus self-temperature rise)
- Solder reflow temperature:
J-STD-020 (latest revision) compliant



Product Specifications								
Part Number ⁸	OCL ¹ (nH)±10%	FLL min. ² (nH)	I _{rms} ³ (Amps)	I _{sat} 1 ⁴ (Amps)	I _{sat} 2 ⁵ (Amps)	I _{sat} 3 ⁶ (Amps)	DCR (mΩ) @ 20°C	K-factor ⁷
FP1208R1-R15-R	150	114	50	85	79	72	0.29±5%	283
FP1208R1-R18-R	180	137		72	66	63		283
FP1208R1-R21-R	210	160		65	57	55		283
FP1208R1-R23-R	230	176		61	53	50		283
FP1208R1-R25-R	250	191		55	48	44		283

1. Open Circuit Inductance (OCL) Test Parameters: 100kHz, 0.1V_{rms}, 0.0Adc@25°C

2. Full Load Inductance (FLL) Test Parameters: 100kHz, 0.1V_{rms}, I_{sat}1

3. I_{rms}: DC current for an approximate temperature rise of 40°C without core loss. Derating is necessary for AC currents. PCB layout, trace thickness and width, air-flow, and proximity of other heat generating components will affect the temperature rise. It is recommended that the temperature of the part not exceed 125°C under worst case operating conditions verified in the end application.

4. I_{sat}1: Peak current for approximately 20% rolloff @ 25°C

5. I_{sat}2: Peak current for approximately 20% rolloff @ 85°C

6. I_{sat}3: Peak current for approximately 20% rolloff @ 125°C

7. K-factor: Used to determine B_{p-p} for core loss (see graph). B_{p-p} = K * L

* $\Delta I \cdot 10^{-3}$. B_{p-p}:(Gauss), K: (K-factor from table), L: (Inductance in nH), ΔI (Peak to peak ripple current in Amps).

8. Part Number Definition: FP1208Rx-Rxx-R:

- FP1208= Product code and size
- Rx= DCR indicator
- Rxx= Inductance value in μH
- "-R" suffix = RoHS compliant

Dimensions- mm

Top View

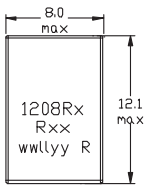

Side View

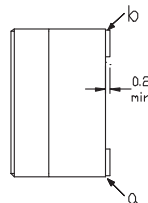

Bottom View

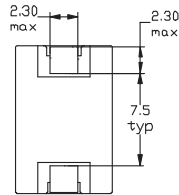

Recommended Pad Layout

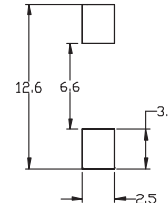

Schematic

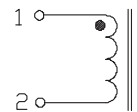

Front View



DCR measured from point "a" to point "b"

Part marking: 1208Rx (Rx= DCR indicator), Rxx = Inductance value in uH (R= decimal point) wllly= date code, r= revision level

Tolerances are +/- 0.15 millimeters unless stated otherwise.

PCB tolerances are +/- 0.10 millimeters unless stated otherwise.

All soldering surfaces to be coplanar within 0.1 millimeters.

Packaging information - mm

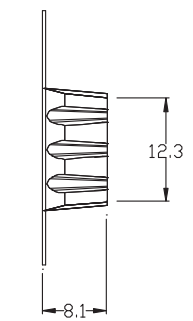
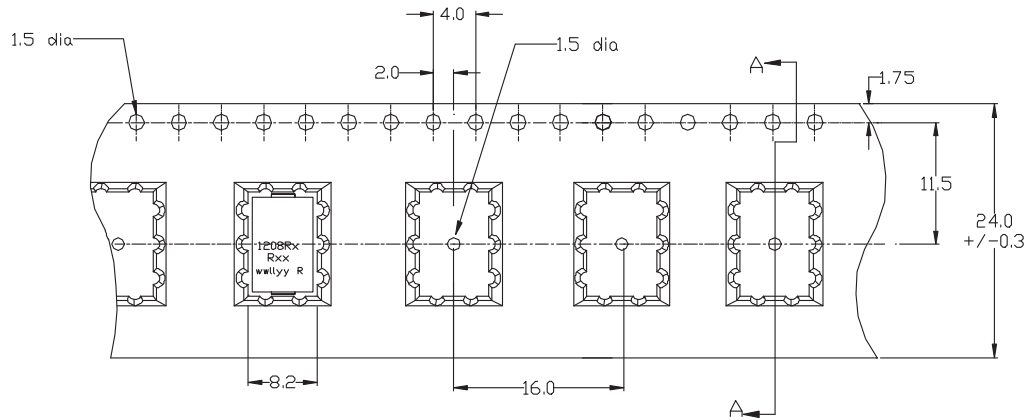

Section A-A

Supplied in tape and reel packaging, 500 parts on a 13" diameter reel.

Temperature rise vs total loss

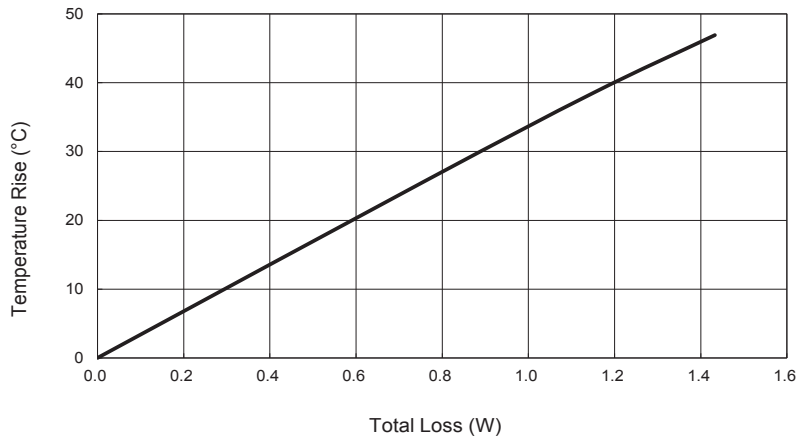

Core loss vs Bp-p

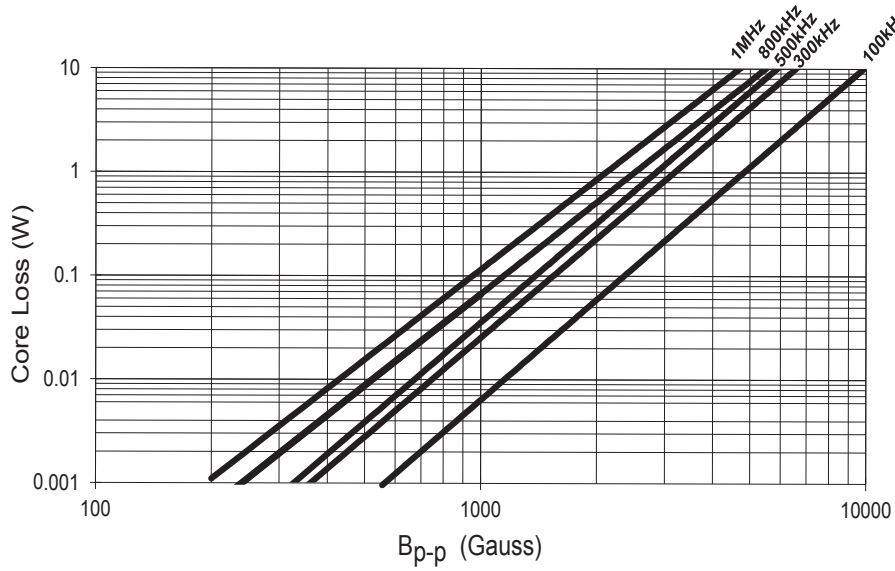

Inductance characteristics

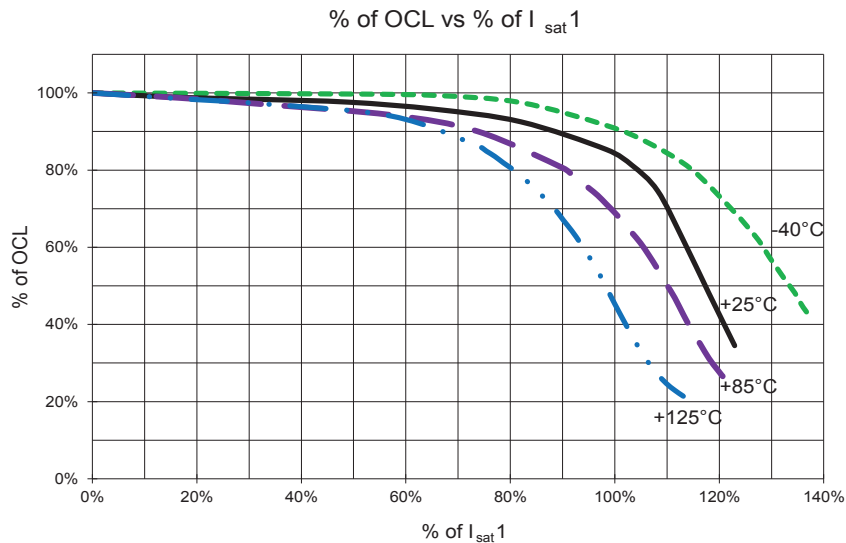

Solder Reflow Profile

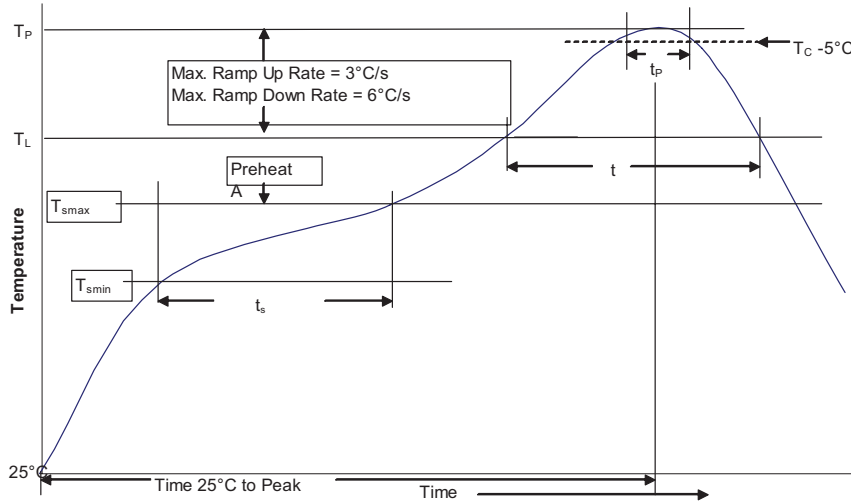

Table 1 - Standard SnPb Solder (T_c)

Package Thickness	Volume mm^3 <350	Volume mm^3 ≥ 350
<2.5mm	235°C	220°C
$\geq 2.5\text{mm}$	220°C	220°C

Table 2 - Lead (Pb) Free Solder (T_c)

Package Thickness	Volume mm^3 <350	Volume mm^3 350 - 2000	Volume mm^3 >2000
<1.6mm	260°C	260°C	260°C
1.6 – 2.5mm	260°C	250°C	245°C
>2.5mm	250°C	245°C	245°C

Reference JDEC J-STD-020

Profile Feature	Standard SnPb Solder	Lead (Pb) Free Solder
Preheat and Soak	• Temperature min. (T_{smin})	100°C
	• Temperature max. (T_{smax})	150°C
	• Time (T_{smin} to T_{smax}) (t_s)	60-120 Seconds
Average ramp up rate T_{smax} to T_p	3°C/ Second Max.	3°C/ Second Max.
Liquidous temperature (T_L)	183°C	217°C
Time at liquidous (t_L)	60-150 Seconds	60-150 Seconds
Peak package body temperature (T_p)*	Table 1	Table 2
Time (t_p)** within 5 °C of the specified classification temperature (T_c)	20 Seconds**	30 Seconds**
Average ramp-down rate (T_p to T_{smax})	6°C/ Second Max.	6°C/ Second Max.
Time 25°C to Peak Temperature	6 Minutes Max.	8 Minutes Max.

* Tolerance for peak profile temperature (T_p) is defined as a supplier minimum and a user maximum.

** Tolerance for time at peak profile temperature (t_p) is defined as a supplier minimum and a user maximum.

Life Support Policy: Eaton does not authorize the use of any of its products for use in life support devices or systems without the express written approval of an officer of the Company. Life support systems are devices which support or sustain life, and whose failure to perform, when properly used in accordance with instructions for use provided in the labeling, can be reasonably expected to result in significant injury to the user.

Eaton reserves the right, without notice, to change design or construction of any products and to discontinue or limit distribution of any products. Eaton also reserves the right to change or update, without notice, any technical information contained in this bulletin.

Eaton
Electronics Division
1000 Eaton Boulevard
Cleveland, OH 44122
United States
www.eaton.com/electronics

© 2017 Eaton
All Rights Reserved
Printed in USA
Publication No. 10148 BU-SB13927
June 2017