

# CAT6218

## LDO Regulator - CMOS

### 300 mA

#### Description

The CAT6218 is a 300 mA CMOS low dropout regulator that provides fast response time during load current and line voltage changes.

The quick-start feature allows the use of an external bypass capacitor to reduce the overall output noise without affecting the turn-on time of just 150  $\mu$ s.

With zero shutdown current and low ground current of 55  $\mu$ A typical, the CAT6218 is ideal for battery-operated devices with supply voltages from 2.3 V to 5.5 V. An internal under voltage lockout circuit disables the output at supply voltages under 2.1 V typical.

The CAT6218 offers 1% initial accuracy and low dropout voltage, 180 mV typical at 300 mA. Stable operation is provided with a small value ceramic capacitor, reducing required board space and component cost.

Other features include fold-back current limit and thermal protection.

The device is available in the low profile (1 mm max height) 5-lead thin SOT23 package.

#### Features

- Guaranteed 300 mA Output Current
- Low Dropout Voltage of 180 mV Typical at 300 mA
- Stable with 1  $\mu$ F Ceramic Output Capacitor
- External 10 nF Bypass Capacitor for Low Noise
- Quick-start Feature
- No-load Ground Current of 55  $\mu$ A Typical
- Full-load Ground Current of 80  $\mu$ A Typical
- $\pm 1.0\%$  Initial Accuracy ( $V_{OUT} \geq 2.0$  V)
- $\pm 2.0\%$  Accuracy Over Temperature ( $V_{OUT} \geq 2.0$  V)
- "Zero" Current Shutdown Mode
- Fold-back Current Limit and Under-voltage Lockout
- Thermal Protection
- Thin SOT23-5 Package
- These Devices are Pb-Free, Halogen Free/BFR Free and are RoHS Compliant

#### Applications

- Cellular Phones
- Battery-powered Devices
- Consumer Electronics



ON Semiconductor®

<http://onsemi.com>

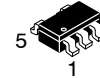

TSOT-23  
TD SUFFIX  
CASE 419AE

#### PIN CONNECTIONS

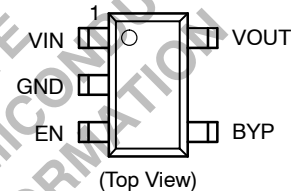

#### MARKING DIAGRAM

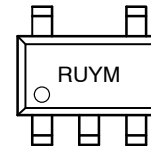

RU = CAT6218 Device Code  
Y = Production Year (last digit)  
M = Production Month: 1 - 9, A, B, C

#### PIN FUNCTION

Pin #	Name	Function
1	VIN	Supply voltage input.
2	GND	Ground reference.
3	EN	Enable input (active high); a 2.5 M $\Omega$ pull-down resistor is provided.
4	BYP	Optional bypass capacitor connection for noise reduction and PSRR enhancing.
5	VOUT	LDO Output Voltage.

#### ORDERING INFORMATION

See detailed ordering and shipping information in the package dimensions section on page 9 of this data sheet.

# CAT6218

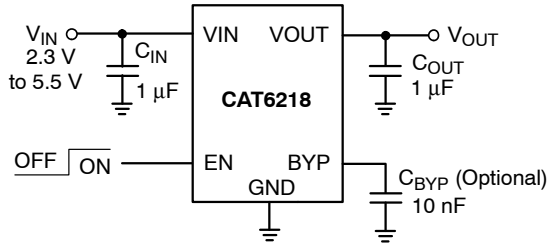

Figure 1. Typical Application Circuit

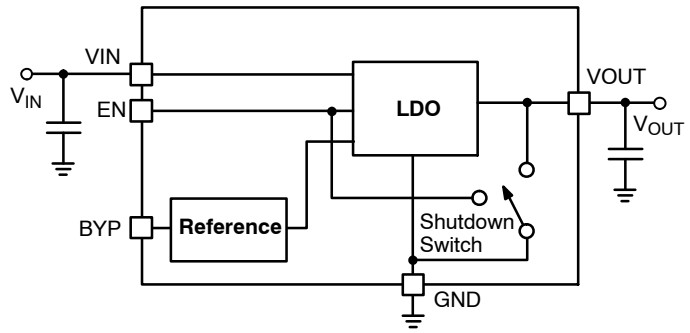

Figure 2. CAT6218 Functional Block Diagram

## Pin Function

**VIN** is the supply pin for the LDO. A small 1 μF ceramic bypass capacitor is required between the VIN pin and ground near the device. When using longer connections to the power supply, CIN value can be increased without limit. The operating input voltage range is from 2.3 V to 5.5 V.

**EN** is the enable control logic (active high) for the regulator output. It has a 2.5 MΩ pull-down resistor, which assures that if EN pin is left open, the circuit is disabled.

**VOUT** is the LDO regulator output. A small 1 μF ceramic bypass capacitor is required between the VOUT pin and ground for stability. For better transient response, its value can be increased to 4.7 μF.

The capacitor should be located near the device. ESR domain is 5 mΩ to 500 mΩ. VOUT can deliver a maximum guaranteed current of 300 mA. For input-to-output voltages higher than 1 V, a continuous 300 mA output current might turn-on the thermal protection. A 250 Ω internal shutdown switch discharges the output capacitor in the no-load condition.

**GND** is the ground reference for the LDO. The pin must be connected to the ground plane on the PCB.

**BYP** is the reference bypass pin. An optional 0.01 μF capacitor can be connected between BYP pin and GND to reduce the output noise and enhance the PSRR at high frequency.

Table 1. ABSOLUTE MAXIMUM RATINGS

Parameter	Rating	Unit
VIN	0 to 6.5	V
VEN, VOUT	-0.3 to VIN + 0.3	V
Junction Temperature, TJ	+150	°C
Power Dissipation, PD	Internally Limited (Note 1)	mW
Storage Temperature Range, TS	-65 to +150	°C
Lead Temperature (soldering, 5 sec.)	260	°C
ESD Rating (Human Body Model)	3	kV

Stresses exceeding Maximum Ratings may damage the device. Maximum Ratings are stress ratings only. Functional operation above the Recommended Operating Conditions is not implied. Extended exposure to stresses above the Recommended Operating Conditions may affect device reliability.

Table 2. RECOMMENDED OPERATING CONDITIONS (Note 2)

Parameter	Range	Unit
VIN	2.3 to 5.5	V
VEN	0 to VIN	V
Junction Temperature Range, TJ	-40 to +125	°C
Package Thermal Resistance (SOT23-5), θJA	235	°C/W

NOTE: Typical application circuit with external components is shown above.

- The maximum allowable power dissipation at any TA (ambient temperature) is  $P_{Dmax} = (T_{Jmax} - T_A)/\theta_{JA}$ . Exceeding the maximum allowable power dissipation will result in excessive die temperature, and the regulator will go into thermal shutdown.
- The device is not guaranteed to work outside its operating rating.

# CAT6218

**Table 3. ELECTRICAL OPERATING CHARACTERISTICS** (Note 3)

( $V_{IN} = V_{OUT} + 1.0$  V,  $V_{EN} = \text{High}$ ,  $I_{OUT} = 100$   $\mu\text{A}$ ,  $C_{IN} = C_{OUT} = 1$   $\mu\text{F}$ , ambient temperature of 25°C (over recommended operating conditions unless specified otherwise). **Bold numbers** apply for the entire junction temperature range.)

Symbol	Parameter	Conditions	Min	Typ	Max	Unit
$V_{OUT-ACC}$	Output Voltage Accuracy	Initial accuracy for $V_{OUT} \geq 2.0$ V (Note 6)	-1.0		+1.0	%
			<b>-2.0</b>		<b>+2.0</b>	
$TC_{OUT}$	Output Voltage Temp. Coefficient			40		ppm/°C
$V_{R-LINE}$	Line Regulation	$V_{IN} = V_{OUT} + 1.0$ V to 5.5 V	-0.2	$\pm 0.1$	+0.2	%/V
			<b>-0.4</b>		<b>+0.4</b>	
$V_{R-LOAD}$	Load Regulation	$I_{OUT} = 100$ $\mu\text{A}$ to 300 mA		0.7	1.2	%
					<b>1.5</b>	
$V_{DROP}$	Dropout Voltage (Note 4)	$I_{OUT} = 300$ mA		180	250	mV
					<b>300</b>	
$I_{GND}$	Ground Current	$I_{OUT} = 0$ $\mu\text{A}$		55	75	$\mu\text{A}$
		$I_{OUT} = 300$ mA		80	<b>90</b>	
$I_{GND-SD}$	Shutdown Ground Current	$V_{EN} < 0.4$ V			1	$\mu\text{A}$
					<b>2</b>	
PSRR	Power Supply Rejection Ratio	$f = 1$ kHz, $C_{BYP} = 10$ nF		64		dB
		$f = 20$ kHz, $C_{BYP} = 10$ nF		54		
$I_{SC}$	Output short circuit current limit	$V_{OUT} = 0$ V		180		mA
$T_{ON}$	Turn-On Time	$C_{BYP} = 10$ nF		150		$\mu\text{s}$
$e_N$	Output Noise Voltage (Note 5)	BW = 10 Hz to 100 kHz		45		$\mu\text{V}_{rms}$
$R_{OUT-SH}$	Shutdown Switch Resistance			250		$\Omega$
$R_{EN}$	Enable pull-down resistor			2.5		M $\Omega$
$V_{UVLO}$	Under-voltage lock out (UVLO) threshold			2.1		V
ESR	$C_{OUT}$ equivalent series resistance		5		500	m $\Omega$

## ENABLE INPUT

$V_{HI}$	Logic High Level	$V_{IN} = 2.3$ to 5.5 V	<b>1.8</b>			V
		$V_{IN} = 2.3$ to 5.5 V, 0°C to +125°C junction temperature	1.6			
$V_{LO}$	Logic Low Level	$V_{IN} = 2.3$ to 5.5 V			<b>0.4</b>	V
$I_{EN}$	Enable Input Current	$V_{EN} = 0.4$ V		0.15	<b>1</b>	$\mu\text{A}$
		$V_{EN} = V_{IN}$		1.5	<b>4</b>	

## THERMAL PROTECTION

$T_{SD}$	Thermal Shutdown			160		°C
$T_{HYS}$	Thermal Hysteresis			10		°C

3. Specification for 2.80 V output version unless specified otherwise.
4. Dropout voltage is defined as the input-to-output differential at which the output voltage drops 2% below its nominal value. During test, the input voltage stays always above the minimum 2.3 V.
5. Specification for 1.8 V output version.
6. For  $V_{OUT} < 2.0$  V, the initial accuracy is  $\pm 2\%$  and across temperature  $\pm 3\%$ .

# CAT6218

## TYPICAL CHARACTERISTICS (shown for 2.80 V output option)

( $V_{IN} = 3.85\text{ V}$ ,  $I_{OUT} = 100\ \mu\text{A}$ ,  $C_{IN} = C_{OUT} = 1\ \mu\text{F}$ ,  $C_{BYP} = 10\ \text{nF}$ ,  $T_A = 25^\circ\text{C}$  unless otherwise specified.)

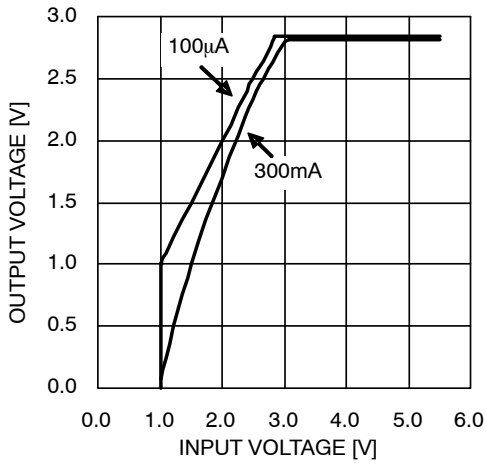

Figure 3. Dropout Characteristics

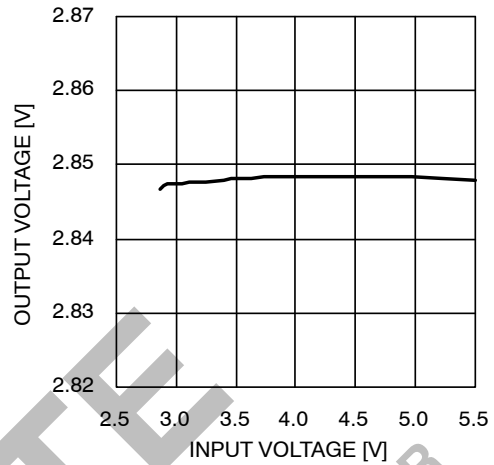

Figure 4. Line Regulation

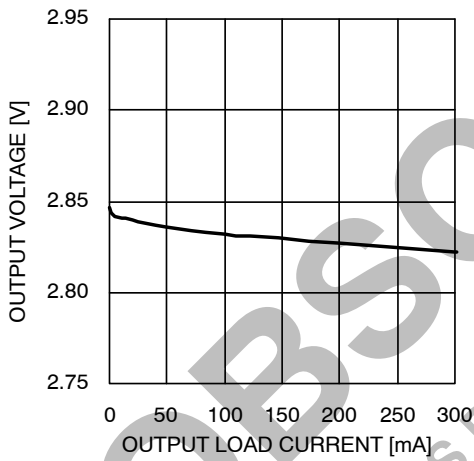

Figure 5. Load Regulation

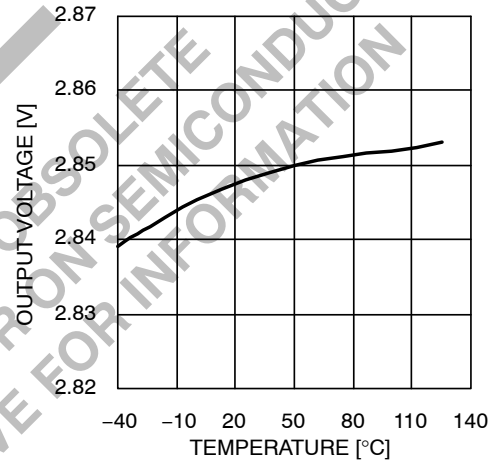

Figure 6. Output Voltage vs. Temperature

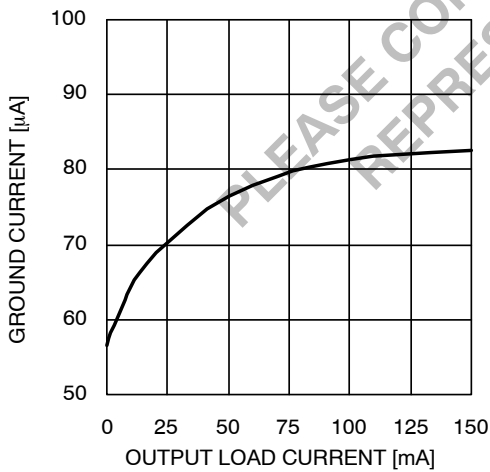

Figure 7. Ground Current vs. Load Current

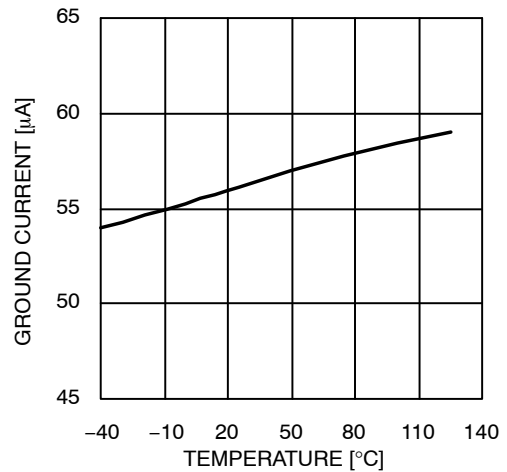

Figure 8. Ground Current vs. Temperature

**TYPICAL CHARACTERISTICS** (shown for 2.80 V output option)

( $V_{IN} = 3.85\text{ V}$ ,  $I_{OUT} = 100\ \mu\text{A}$ ,  $C_{IN} = C_{OUT} = 1\ \mu\text{F}$ ,  $C_{BYP} = 10\ \text{nF}$ ,  $T_A = 25^\circ\text{C}$  unless otherwise specified.)

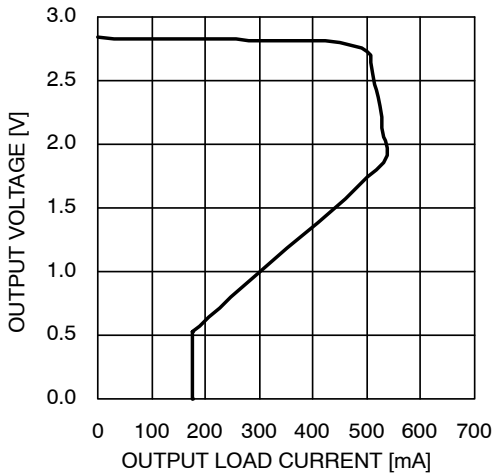

Figure 9. Output Voltage vs. Load Current

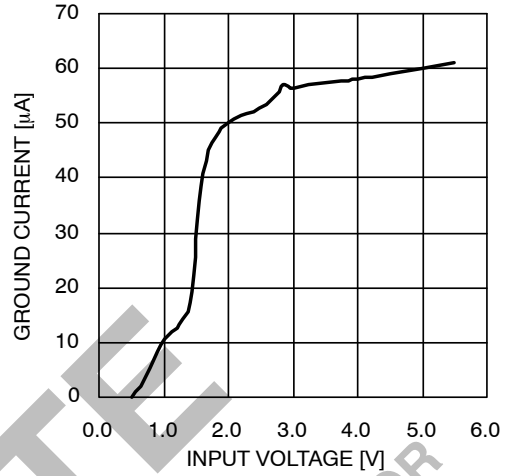

Figure 10. Ground Current vs. Input Voltage

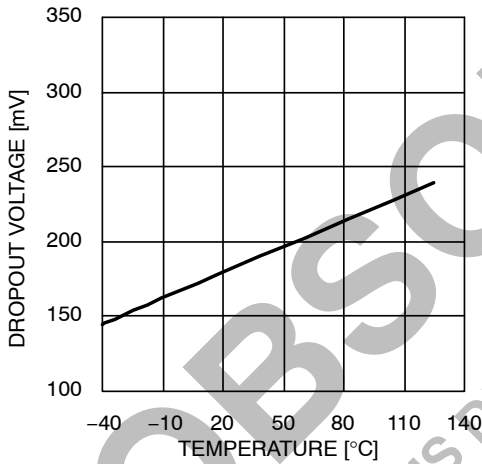

Figure 11. Dropout vs. Temperature (300 mA Load)

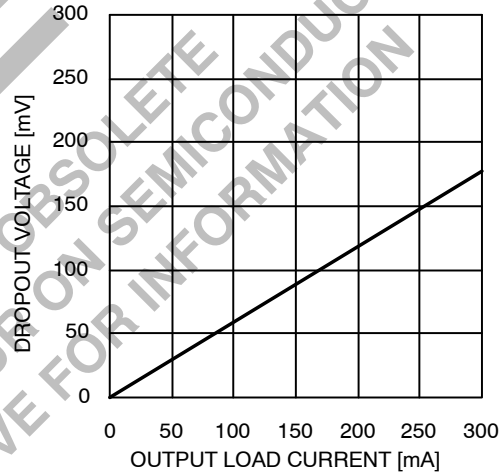

Figure 12. Dropout vs. Load Current

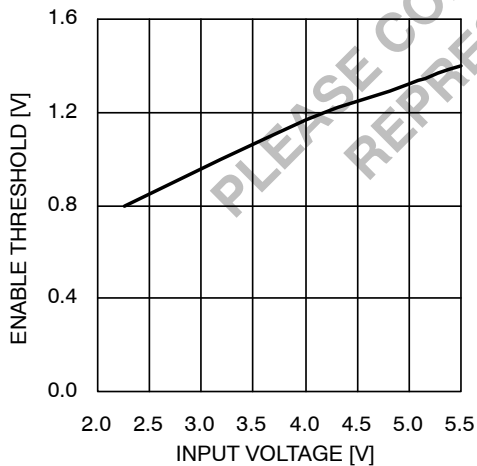

Figure 13. Enable Threshold vs. Input Voltage

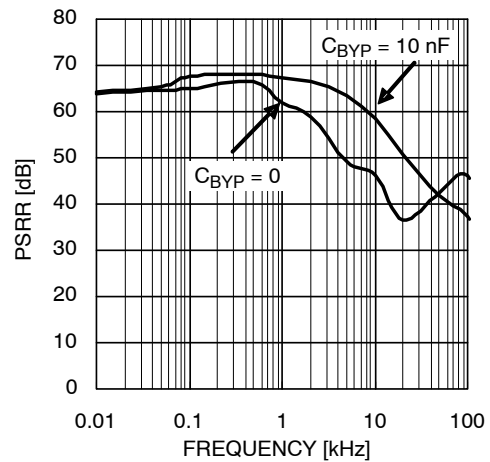

Figure 14. PSRR vs. Frequency (10 mA Load)

# CAT6218

## TYPICAL CHARACTERISTICS (shown for 2.80 V output option)

( $V_{IN} = 3.85\text{ V}$ ,  $I_{OUT} = 100\ \mu\text{A}$ ,  $C_{IN} = C_{OUT} = 1\ \mu\text{F}$ ,  $C_{BYP} = 10\ \text{nF}$ ,  $T_A = 25^\circ\text{C}$  unless otherwise specified.)

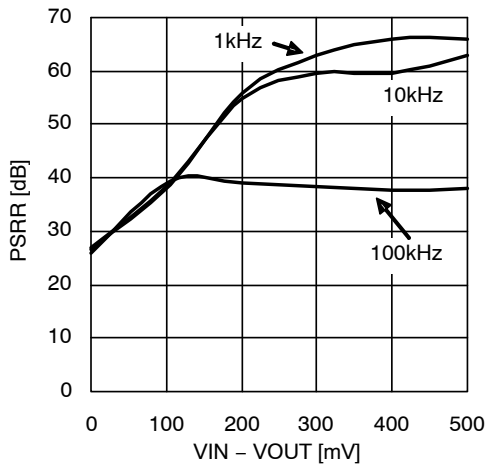

Figure 15. PSRR (30 mA Load)

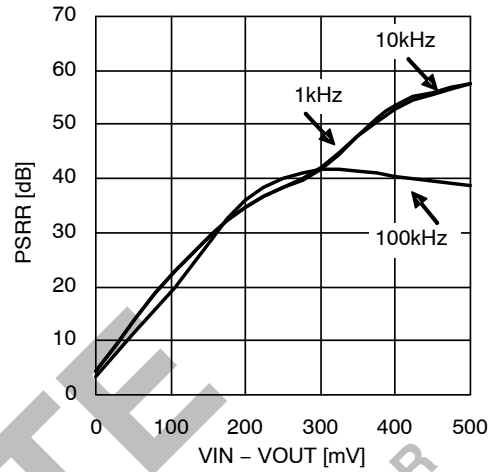

Figure 16. PSRR (200 mA Load)

**OBSOLETE**  
THIS DEVICE IS OBSOLETE  
PLEASE CONTACT YOUR ON SEMICONDUCTOR  
REPRESENTATIVE FOR INFORMATION

**TRANSIENT CHARACTERISTICS** (shown for 2.80 V output option)

( $V_{IN} = 3.85\text{ V}$ ,  $I_{OUT} = 100\ \mu\text{A}$ ,  $C_{IN} = C_{OUT} = 1\ \mu\text{F}$ ,  $C_{BYP} = 10\ \text{nF}$ ,  $T_A = 25^\circ\text{C}$  unless otherwise specified.)

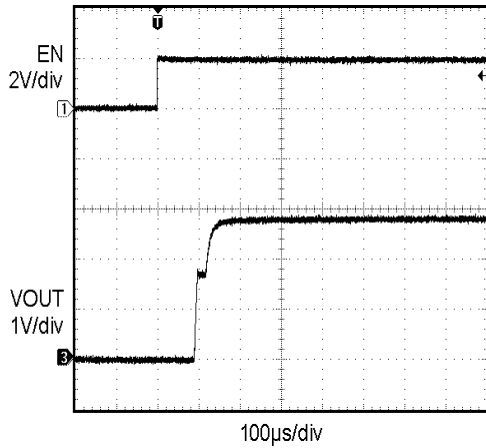

Figure 17. Enable Turn-on (100  $\mu\text{A}$  Load)

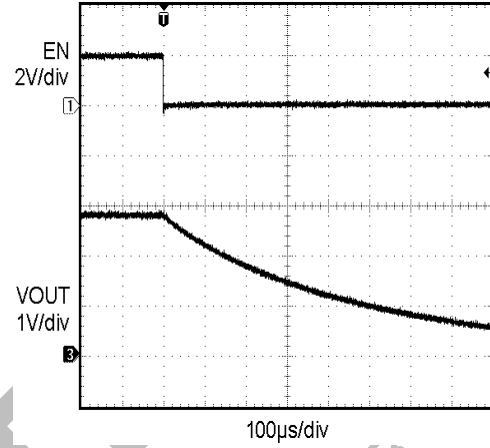

Figure 18. Enable Turn-off (100  $\mu\text{A}$  Load)

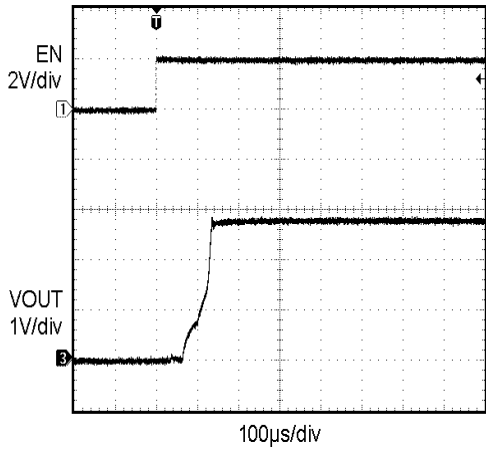

Figure 19. Enable Turn-on (300 mA Load)

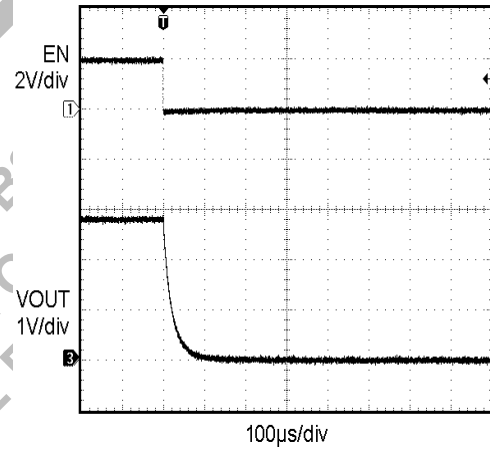

Figure 20. Enable Turn-off (300 mA Load)

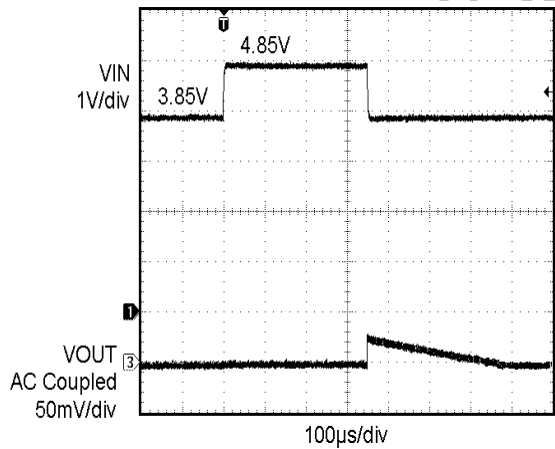

Figure 21. Line Transient Response (3.85 V to 4.85 V)

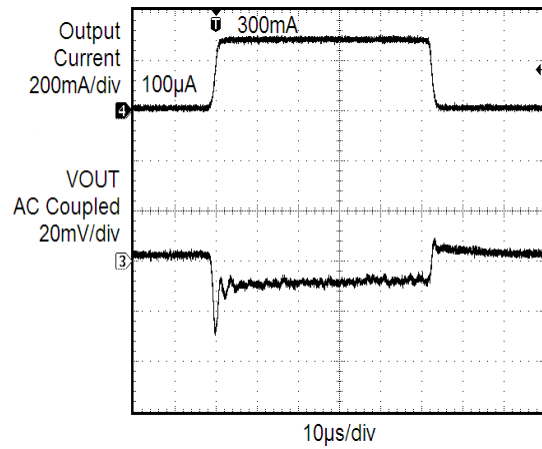

Figure 22. Load Transient Response (0.1 mA to 300 mA)

Note: All transient characteristics are generated using the evaluation board CAT621XEVAL1.

# CAT6218

## PACKAGE DIMENSIONS

TSOT-23, 5 LEAD  
CASE 419AE-01  
ISSUE O

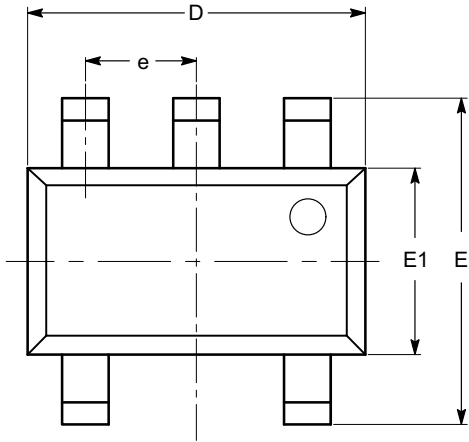

TOP VIEW

SYMBOL	MIN	NOM	MAX
A			1.00
A1	0.01	0.05	0.10
A2	0.80	0.87	0.90
b	0.30		0.45
c	0.12	0.15	0.20
D	2.90 BSC		
E	2.80 BSC		
E1	1.60 BSC		
e	0.95 TYP		
L	0.30	0.40	0.50
L1	0.60 REF		
L2	0.25 BSC		
$\theta$	0°		8°

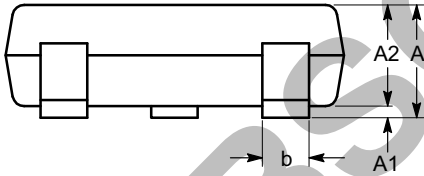

SIDE VIEW

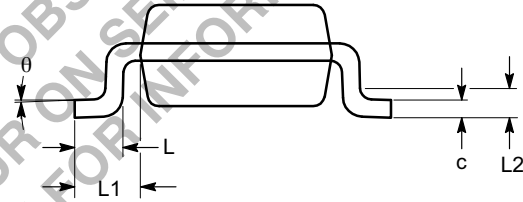

END VIEW

**Notes:**

- (1) All dimensions are in millimeters. Angles in degrees.
- (2) Complies with JEDEC MO-193.



# CAT6218

## Example of Ordering Information (Note 9)

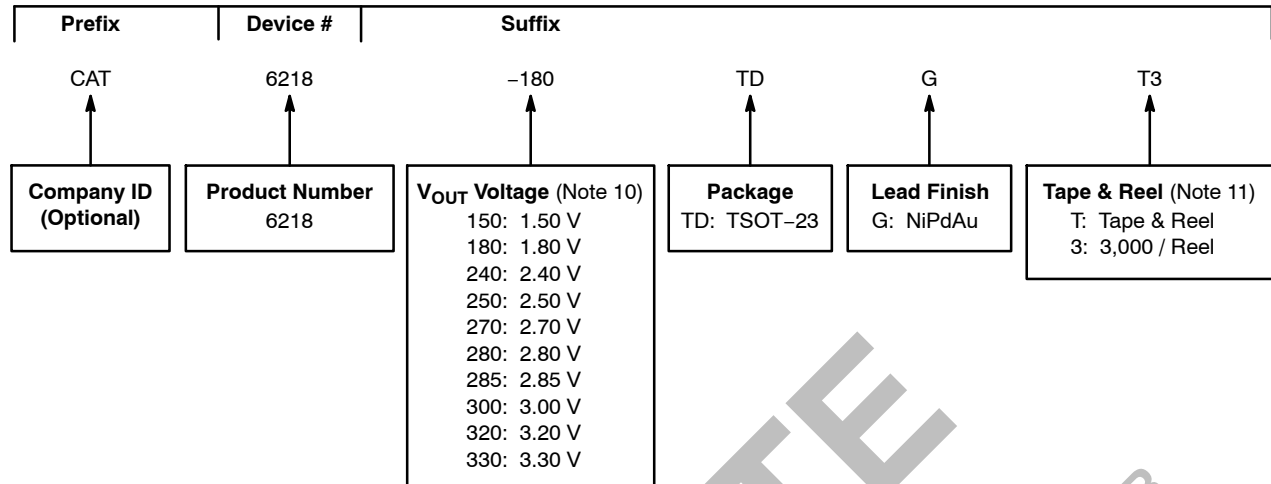

## ORDERING INFORMATION

Orderable Part Number	V <sub>OUT</sub> Voltage	Package	Shipping
CAT6218-150TDGT3	1.50 V	TSOT-23	3,000 / Tape & Reel
CAT6218-180TDGT3	1.80 V	TSOT-23	3,000 / Tape & Reel
CAT6218-240TDGT3	2.40 V	TSOT-23	3,000 / Tape & Reel
CAT6218-250TDGT3	2.50 V	TSOT-23	3,000 / Tape & Reel
CAT6218-270TDGT3	2.70 V	TSOT-23	3,000 / Tape & Reel
CAT6218-280TDGT3	2.80 V	TSOT-23	3,000 / Tape & Reel
CAT6218-285TDGT3 (Note 10)	2.85 V	TSOT-23	3,000 / Tape & Reel
CAT6218-300TDGT3	3.00 V	TSOT-23	3,000 / Tape & Reel
CAT6218-320TDGT3 (Note 10)	3.20 V	TSOT-23	3,000 / Tape & Reel
CAT6218-330TDGT3	3.30 V	TSOT-23	3,000 / Tape & Reel

7. All packages are RoHS-compliant (Lead-free, Halogen-free).

8. The standard finish is NiPdAu.

9. The device used in the above example is a CAT6218-180TDGT3 (V<sub>OUT</sub> = 1.8 V, in a TSOT-23 package, NiPdAu, Tape & Reel, 3,000/Reel).

10. For other voltage options, please contact your nearest ON Semiconductor Sales office.

11. For information on tape and reel specifications, including part orientation and tape sizes, please refer to our Tape and Reel Packaging Specifications Brochure, BRD8011/D.

ON Semiconductor and  are registered trademarks of Semiconductor Components Industries, LLC (SCILLC). SCILLC reserves the right to make changes without further notice to any products herein. SCILLC makes no warranty, representation or guarantee regarding the suitability of its products for any particular purpose, nor does SCILLC assume any liability arising out of the application or use of any product or circuit, and specifically disclaims any and all liability, including without limitation special, consequential or incidental damages. "Typical" parameters which may be provided in SCILLC data sheets and/or specifications can and do vary in different applications and actual performance may vary over time. All operating parameters, including "Typicals" must be validated for each customer application by customer's technical experts. SCILLC does not convey any license under its patent rights nor the rights of others. SCILLC products are not designed, intended, or authorized for use as components in systems intended for surgical implant into the body, or other applications intended to support or sustain life, or for any other application in which the failure of the SCILLC product could create a situation where personal injury or death may occur. Should Buyer purchase or use SCILLC products for any such unintended or unauthorized application, Buyer shall indemnify and hold SCILLC and its officers, employees, subsidiaries, affiliates, and distributors harmless against all claims, costs, damages, and expenses, and reasonable attorney fees arising out of, directly or indirectly, any claim of personal injury or death associated with such unintended or unauthorized use, even if such claim alleges that SCILLC was negligent regarding the design or manufacture of the part. SCILLC is an Equal Opportunity/Affirmative Action Employer. This literature is subject to all applicable copyright laws and is not for resale in any manner.

## PUBLICATION ORDERING INFORMATION

### LITERATURE FULFILLMENT:

Literature Distribution Center for ON Semiconductor  
P.O. Box 5163, Denver, Colorado 80217 USA  
Phone: 303-675-2175 or 800-344-3860 Toll Free USA/Canada  
Fax: 303-675-2176 or 800-344-3867 Toll Free USA/Canada  
Email: orderlit@onsemi.com

**N. American Technical Support:** 800-282-9855 Toll Free  
USA/Canada  
**Europe, Middle East and Africa Technical Support:**  
Phone: 421 33 790 2910  
**Japan Customer Focus Center**  
Phone: 81-3-5773-3850

**ON Semiconductor Website:** [www.onsemi.com](http://www.onsemi.com)

**Order Literature:** <http://www.onsemi.com/orderlit>

For additional information, please contact your local Sales Representative