

REVISIONS

P	LTR	DESCRIPTION	DATE	DWN	APVD
	BA1	ECR-14-010250	16JUL2014	KR	TN

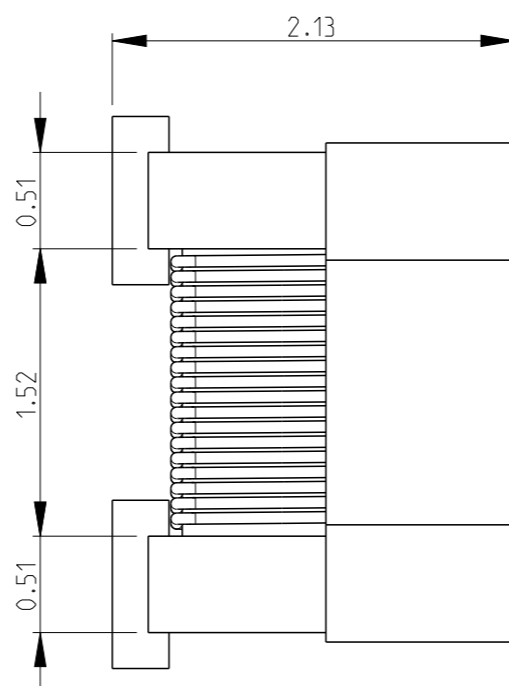
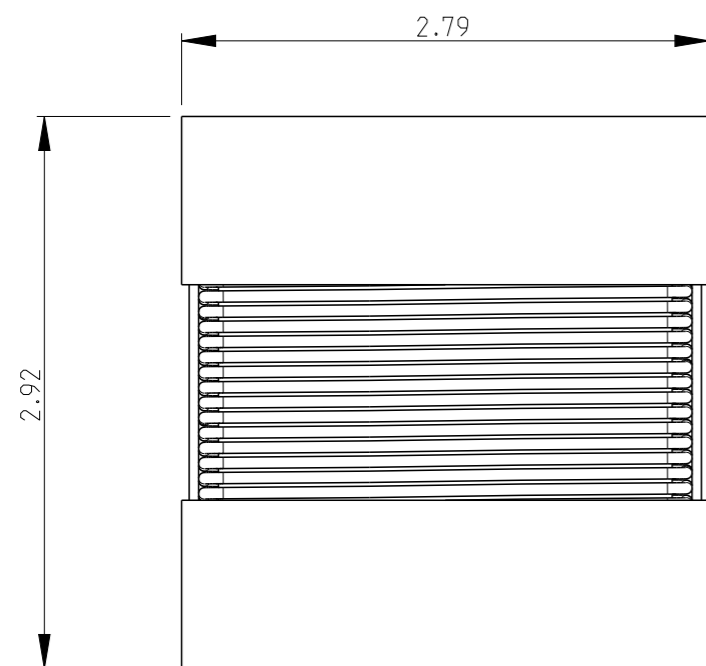

- 1 TERMINAL WRAPAROUND APPROX 0.007" (0.18mm) BOTH ENDS
- 2 FOR FURTHER INFORMATION SEE DATA SHEET FOR 3650 SERIES-LOW INDUCTANCE, HIGH FREQUENCY CHIP INDUCTOR

RECOMMENDED LAND PATTERN FOR 3650-2C SERIES

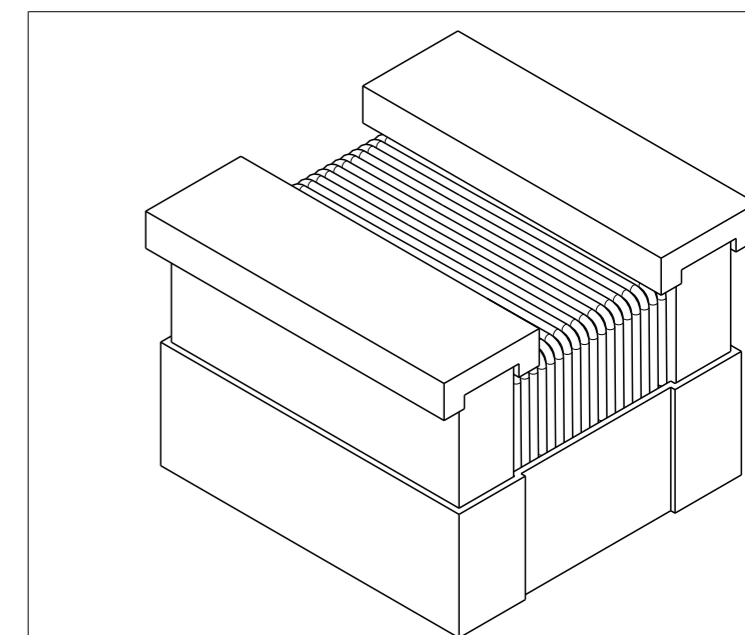
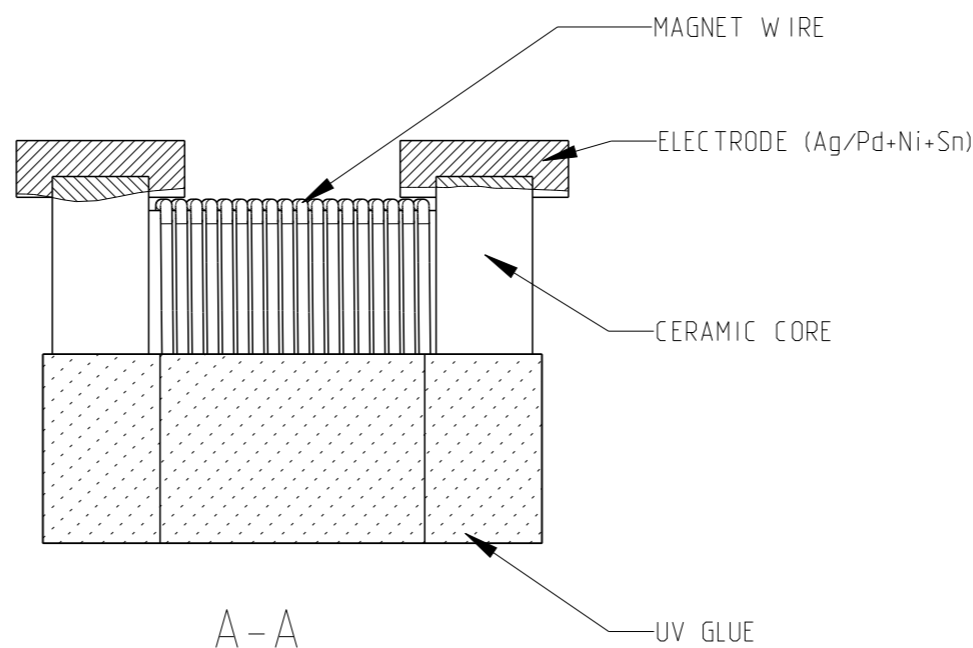
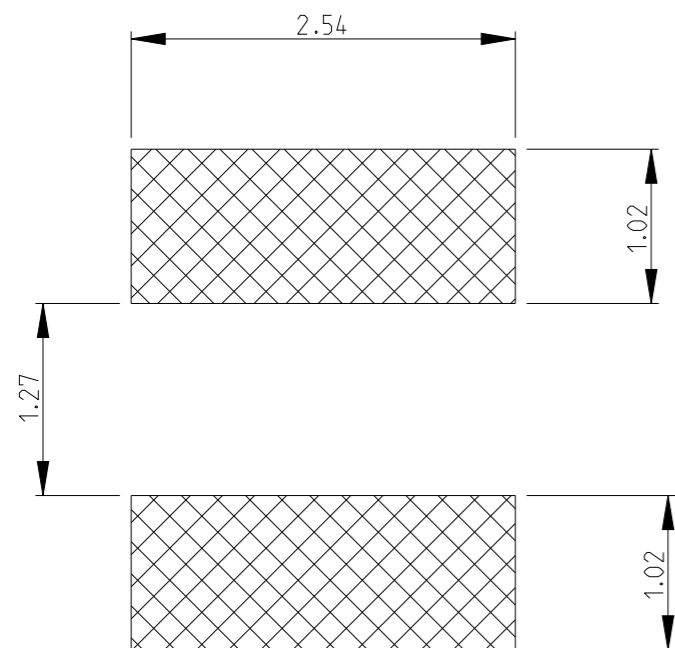

ROHS Compliant

THIS DRAWING IS A CONTROLLED DOCUMENT.

DIMENSIONS:		TOLERANCES UNLESS OTHERWISE SPECIFIED:	
mm			
	0 PLC	±0.2	
	1 PLC	±0.1	
	2 PLC	±	
	3 PLC	±	
	4 PLC	±	
	ANGLES	±5°	
MATERIAL		FINISH	
-	-	-	-

DWN	SUBHASH.M	04-AUG-09
CHK	ALLAN.P	04-AUG-09
APVD	STEPHEN.P	04-AUG-09
PRODUCT SPEC	-	-
APPLICATION SPEC	-	-
WEIGHT	-	-
Customer Drawing		



NAME				LOW INDUCTANCE, HIGH FREQUENCY CHIP INDUCTOR SERIES 3650 2C	
SIZE	CAGE CODE	DRAWING NO	RESTRICTED TO		
A3	00779	C-1879023	-		
SCALE		SHEET	OF	REV	
NTS		1	1	BA1	

# Mouser Electronics

Authorized Distributor

Click to View Pricing, Inventory, Delivery & Lifecycle Information:

[TE Connectivity:](#)

[36502CR91JTDG](#)