

THIS DOCUMENT IS THE PROPERTY OF
KEYSTONE ELECTRONICS CORP. AND
SHALL NOT BE REPRODUCED, DISTRIBUTED
OR USED AS A BASIS FOR MANUFACTURE
WITHOUT PRIOR WRITTEN PERMISSION
FROM KEYSTONE ELECTRONICS CORP.

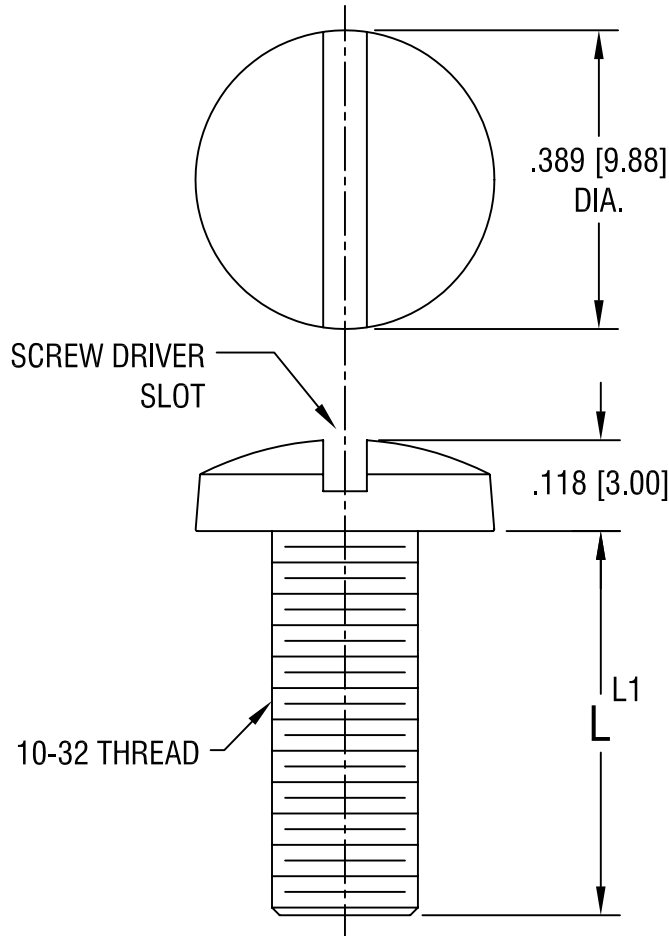

PART NO.	'L' DIM.	'L1' TOL. +0.0
9423	.500 [12.70]	-.020 [-0.50]
9424	.750 [19.05]	-.030 [-0.76]
9425	1.000 [25.40]	
9426	1.500 [38.10]	-.060 [-1.52]

KEYSTONE ELECTRONICS CORP.

ASTORIA, N.Y. 11105-2017

PART NAME

10-32 BINDING HEAD SCREW

MATERIAL

STEEL

FINISH

ZINC PLATE

DRN BY

BOONE

DATE

3.1.04

APPD

LN

SCALE

4X

TOLERANCES

INCH [MM]

DECIMAL $\pm .010$ [± 0.25]

ANGULAR $\pm 1^\circ$

UNLESS OTHERWISE SPECIFIED

CODE

C/M

DWG NO.

9423-9426

DATE

DESCRIPTION

REV.

Mouser Electronics

Authorized Distributor

Click to View Pricing, Inventory, Delivery & Lifecycle Information:

[Keystone Electronics:](#)

[9424](#)