

NOTE:

1. MATERIAL:
HSG & CAP - NYLON, GLASS FILLED
UL 94V-0, COLOUR BLACK
PIN - 0.50 SQ PHOSPHOR BRONZE
2. PLATING OPTION:
(1) 0.76µm MIN GOLD PLATE AT CONTACT AREA,
TIN PLATE AT SOLDER AREA,
BOTH OVER NICKEL UNDERPLATE
(2) 0.38µm MIN GOLD PLATE AT CONTACT AREA,
TIN PLATE AT SOLDER AREA,
BOTH OVER NICKEL UNDERPLATE
(3) 0.05 - 0.25µm GOLD PLATE AT CONTACT AREA,
TIN PLATE AT SOLDER AREA,
BOTH OVER NICKEL UNDERPLATE
3. PIN PUSHOUT FORCE: 1KG MIN IN EITHER DIRECTION
4. PRODUCT SPEC PS-87761-100 APPLIES.
5. BEND DEPRESSION IS ACCEPTABLE SO LONG AS IT DOES NOT AFFECT THE OVERALL COPLANARITY OF TAIL.
6. COPLANARITY IS TO BE MEASURED BY RESTING THE SOLDER TAIL ON A FLAT SURFACE.
7. CAP TO BE LOCATED AS CENTRAL OF PART AS POSSIBLE
TOP SURFACE OF CAP TO BE FLAT FOR THE PURPOSE OF PICK & PLACE BY VACUUM SUCTION NOZZLE.
8. FOR ILLUSTRATION PURPOSES, 12CKT IS SHOWN.
9. CKT 4 & 6 IS CUT FROM CKT 8 & 12 RESPECTIVELY
ROUGH EDGES ARE EXPECTED ALONG THE CUTTING EDGES.
10. PACKAGING SPECIFICATION:
FOR TRAY: PK-89990-487
FOR TUBE: PK-89990-476/ PK-89990-474/ PK-89990-475
FOR T&R: PK-89990-484/ 485

THIS DRAWING CONTAINS INFORMATION THAT IS PROPRIETARY TO MOLEX ELECTRONIC TECHNOLOGIES, LLC AND SHOULD NOT BE USED WITHOUT WRITTEN PERMISSION									
DIMENSION UNITS		SCALE		CURRENT REV DESC: ADD 87759-3279				molex	
mm		NTS							
GENERAL TOLERANCES (UNLESS SPECIFIED)				EC NO: 174700				CUSTOM HEADER	
				DRWN: NVELUSAMY 2017/12/28				MGRID, 2MM DUAL ROW HDR. SMT	
4 PLACES ±				CHK'D: SCS02 2018/04/06				PRODUCT CUSTOMER DRAWING	
3 PLACES ±				APPR: ISHWARG 2018/04/18					
2 PLACES ± 0.2				INITIAL REVISION:				DOCUMENT NUMBER	
1 PLACE ±				DRWN: KSEE 2003/12/12				SD-87759-117	
0 PLACES ±				APPR: SKTOH 2004/01/12				DOC TYPE DOC PART REVISION	
ANGULAR TOL ± 3.0°				DRAFT WHERE APPLICABLE MUST REMAIN WITHIN DIMENSIONS				PSD 001 B10	
				THIRD ANGLE PROJECTION		DRAWING		SHEET NUMBER	
				A3-SIZE		SERIES 87759		1 OF 8	
				MATERIAL NUMBER		CUSTOMER			
				SEE TABLE		GENERAL MARKET			

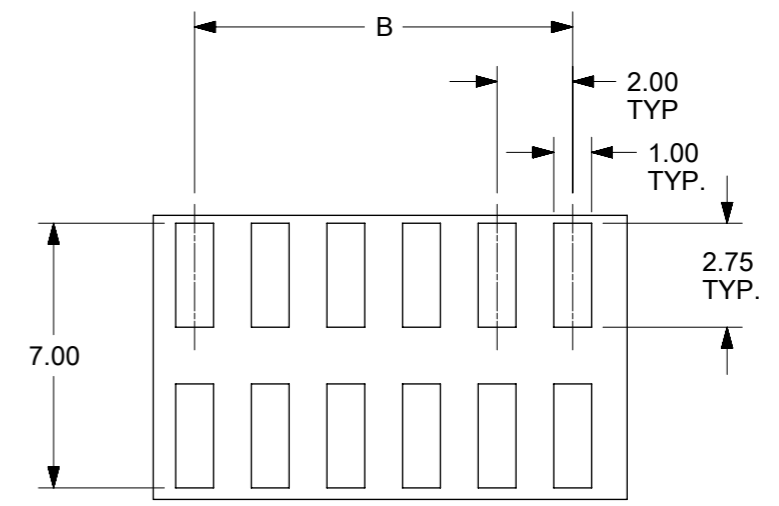
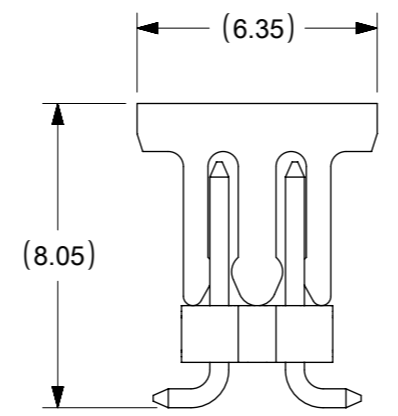
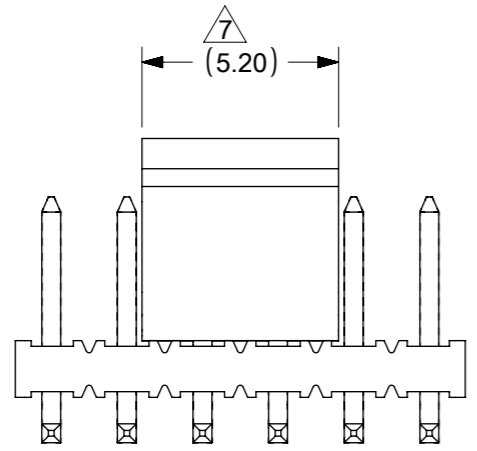

RECOMMENDED SOLDER PAD LAYOUT

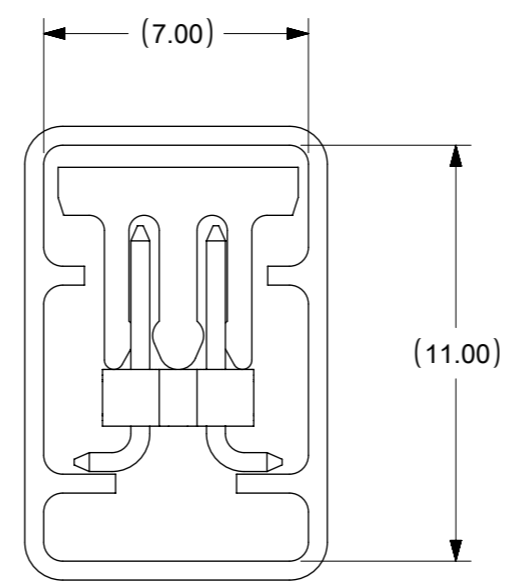
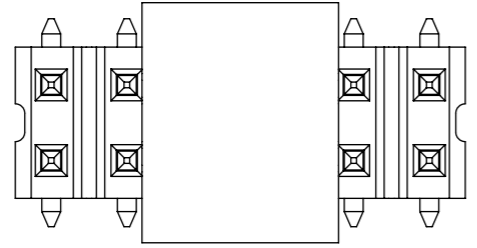

THIS DRAWING CONTAINS INFORMATION THAT IS PROPRIETARY TO MOLEX ELECTRONIC TECHNOLOGIES, LLC AND SHOULD NOT BE USED WITHOUT WRITTEN PERMISSION									
DIMENSION UNITS		SCALE		CURRENT REV DESC: ADD 87759-3279				molex	
mm		NTS							
GENERAL TOLERANCES (UNLESS SPECIFIED)				EC NO: 174700				CUSTOM HEADER	
				DRWN: NVELUSAMY 2017/12/28				MGRID, 2MM DUAL ROW HDR. SMT	
				CHK'D: SCS02 2018/04/06				PRODUCT CUSTOMER DRAWING	
				APPR: ISHWARG 2018/04/18					
4 PLACES ±				INITIAL REVISION:				DOCUMENT NUMBER	
3 PLACES ±				DRWN: KSEE 2003/12/12				SD-87759-117	
2 PLACES ± 0.2				APPR: SKTOH 2004/01/12				PSD 001 B10	
1 PLACE ±				MATERIAL NUMBER				CUSTOMER	
0 PLACES ±				A3-SIZE 87759				GENERAL MARKET	
ANGULAR TOL ± 3.0°				THIRD ANGLE PROJECTION		SERIES		SHEET NUMBER	
DRAFT WHERE APPLICABLE MUST REMAIN WITHIN DIMENSIONS				SEE TABLE		2 OF 8			

EMBOSSED CARRIER TAPE TYPE "A"

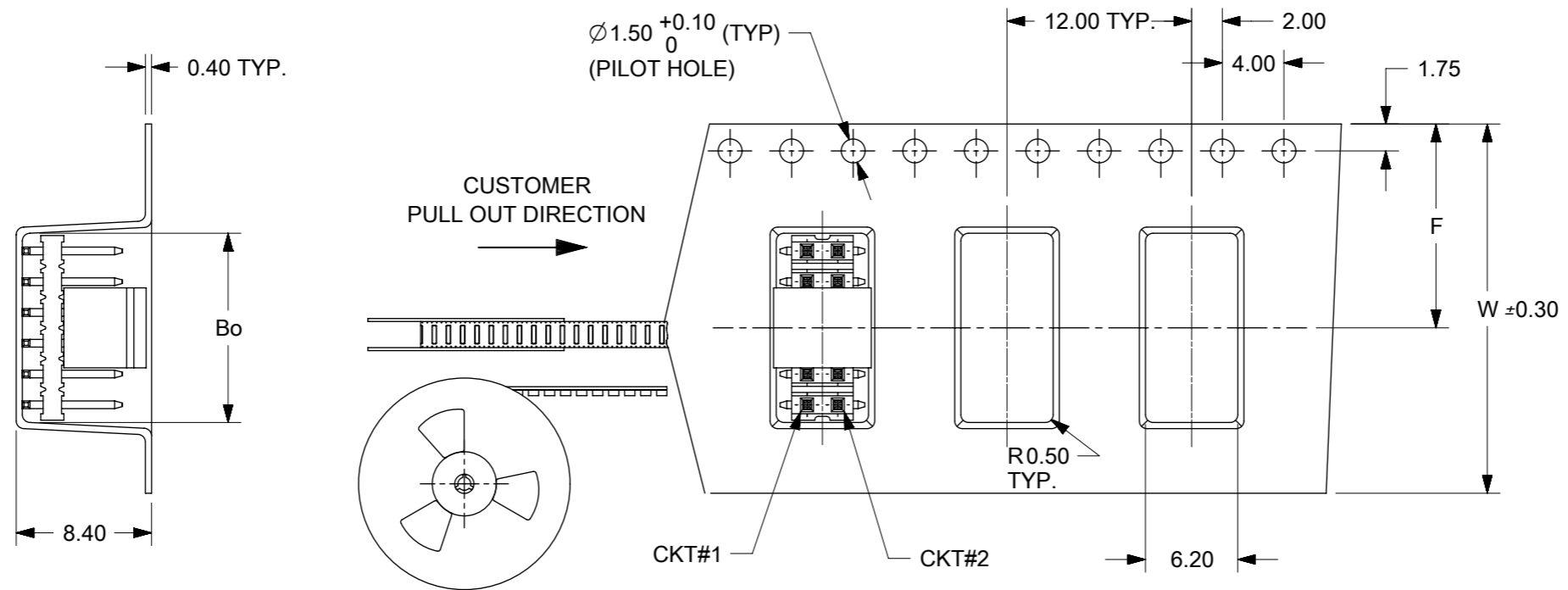

NOTES:

12. LEADER AND TRAILER TAPE

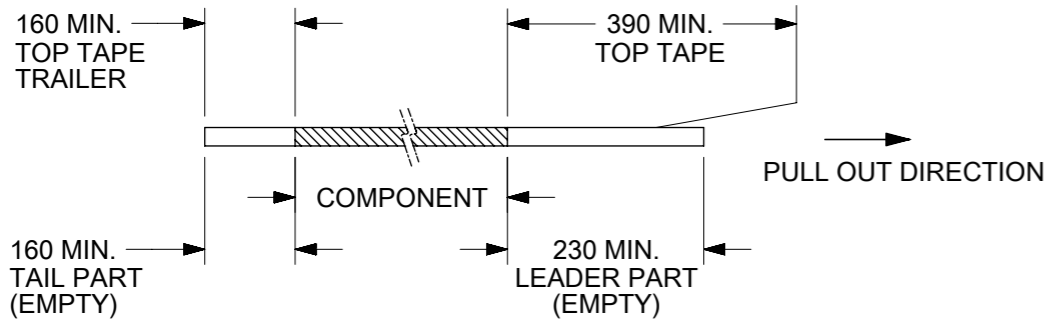

13. PEELING OFF FORCE OF THE TOP TAPE: 20 - 80gf.
(PEELING DIRECTION AS SHOWN IN FOLLOWING FIGURE)

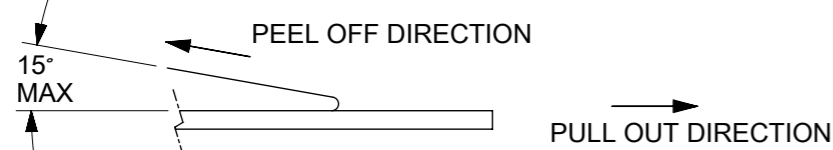

- 14. PACKAGING STANDARD IS AS PER EIA-481.
- 15. TAPE & REEL QUANTITY = SEE TABLE
- 16. THE TAPE IS TREATED FOR ANTI-STATIC

THIS DRAWING CONTAINS INFORMATION THAT IS PROPRIETARY TO MOLEX ELECTRONIC TECHNOLOGIES, LLC AND SHOULD NOT BE USED WITHOUT WRITTEN PERMISSION											
DIMENSION UNITS		SCALE		CURRENT REV DESC: ADD 87759-3279						molex	
mm		NTS									
GENERAL TOLERANCES (UNLESS SPECIFIED)				EC NO: 174700		DRWN: NVELUSAMY		2017/12/28		CUSTOMER	
				DRWN: KSEE		2003/12/12		MGRID, 2MM DUAL ROW HDR. SMT			
4 PLACES ±				APP: ISHWARG		2018/04/06		PRODUCT CUSTOMER DRAWING			
3 PLACES ±				DRWN: KSEE		2004/01/12		DOCUMENT NUMBER		DOC TYPE	
2 PLACES ± 0.2				APP: SKTOH		2018/04/18		SD-87759-117		PSD	
1 PLACE ±				INITIAL REVISION:				001		REVISION	
0 PLACES ±				ANGULAR TOL ± 3.0°				B10			
DRAFT WHERE APPLICABLE MUST REMAIN WITHIN DIMENSIONS				THIRD ANGLE PROJECTION		DRAWING		SERIES		MATERIAL NUMBER	
				A3-SIZE		87759		SEE TABLE		CUSTOMER	
								GENERAL MARKET		SHEET NUMBER	
								3 OF 8			

DOCUMENT STATUS	P1	RELEASE DATE	2018/04/18	05:28:02
-----------------	----	--------------	------------	----------

EMBOSED CARRIER TAPE TYPE "B"

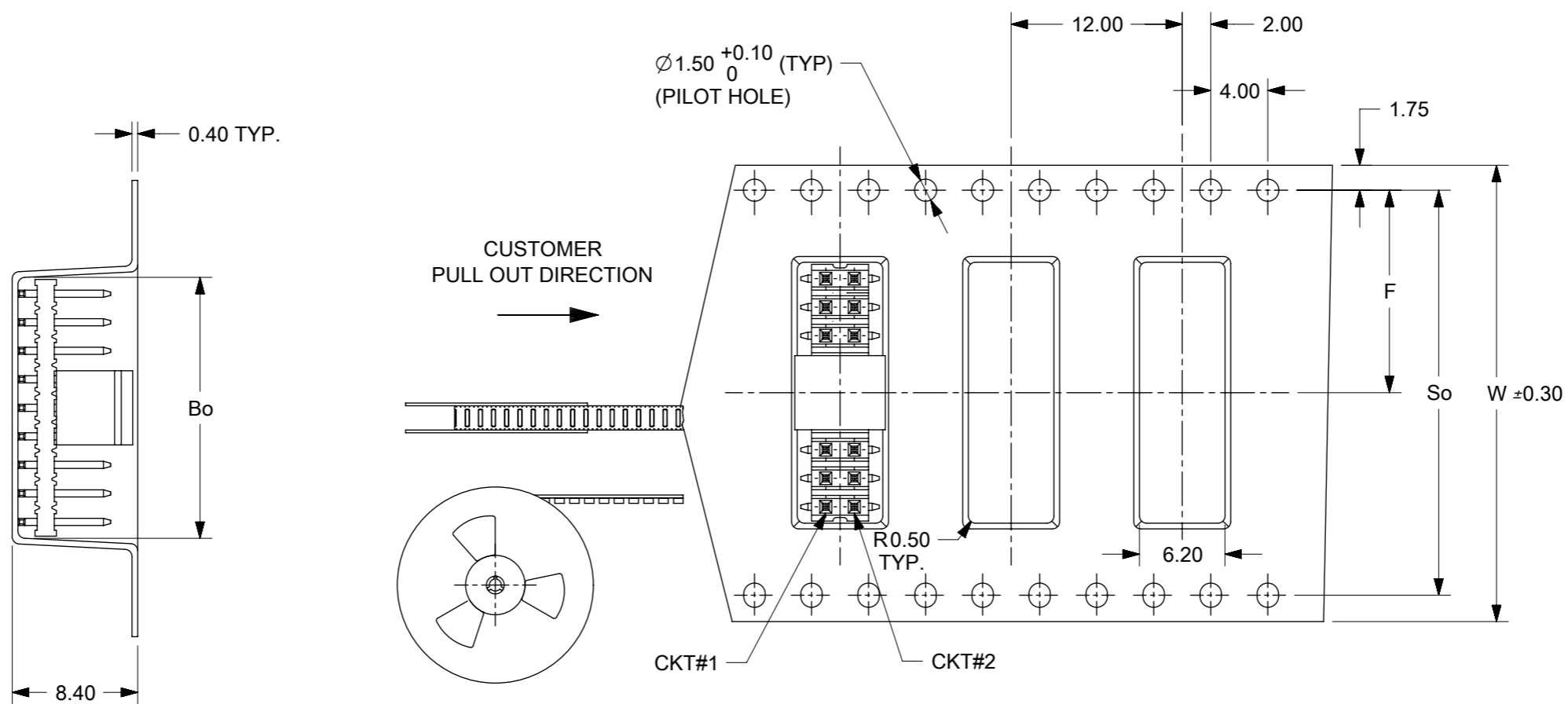

THIS DRAWING CONTAINS INFORMATION THAT IS PROPRIETARY TO MOLEX ELECTRONIC TECHNOLOGIES, LLC AND SHOULD NOT BE USED WITHOUT WRITTEN PERMISSION									
DIMENSION UNITS		SCALE		CURRENT REV DESC: ADD 87759-3279				molex	
mm		NTS							
GENERAL TOLERANCES (UNLESS SPECIFIED)				EC NO: 174700		CUSTOMER		CUSTOMER	
				DRWN: NVELUSAMY		2017/12/28		MGRID, 2MM DUAL ROW HDR. SMT	
4 PLACES ±				CHK'D: SCS02		2018/04/06		PRODUCT CUSTOMER DRAWING	
3 PLACES ±				APPR: ISHWARG		2018/04/18			
2 PLACES ± 0.2				INITIAL REVISION:		DOCUMENT NUMBER		DOC TYPE	
1 PLACE ±				DRWN: KSEE		2003/12/12		DOC PART	
0 PLACES ±				APPR: SKTOH		2004/01/12		REVISION	
ANGULAR TOL ± 3.0°				DRAFT WHERE APPLICABLE MUST REMAIN WITHIN DIMENSIONS		THIRD ANGLE PROJECTION		SERIES	
				DRAWING		MATERIAL NUMBER		CUSTOMER	
				A3-SIZE		87759		SEE TABLE	
				GENERAL MARKET		4 OF 8			

EMBOSSED CARRIER TAPE TYPE 'B1'

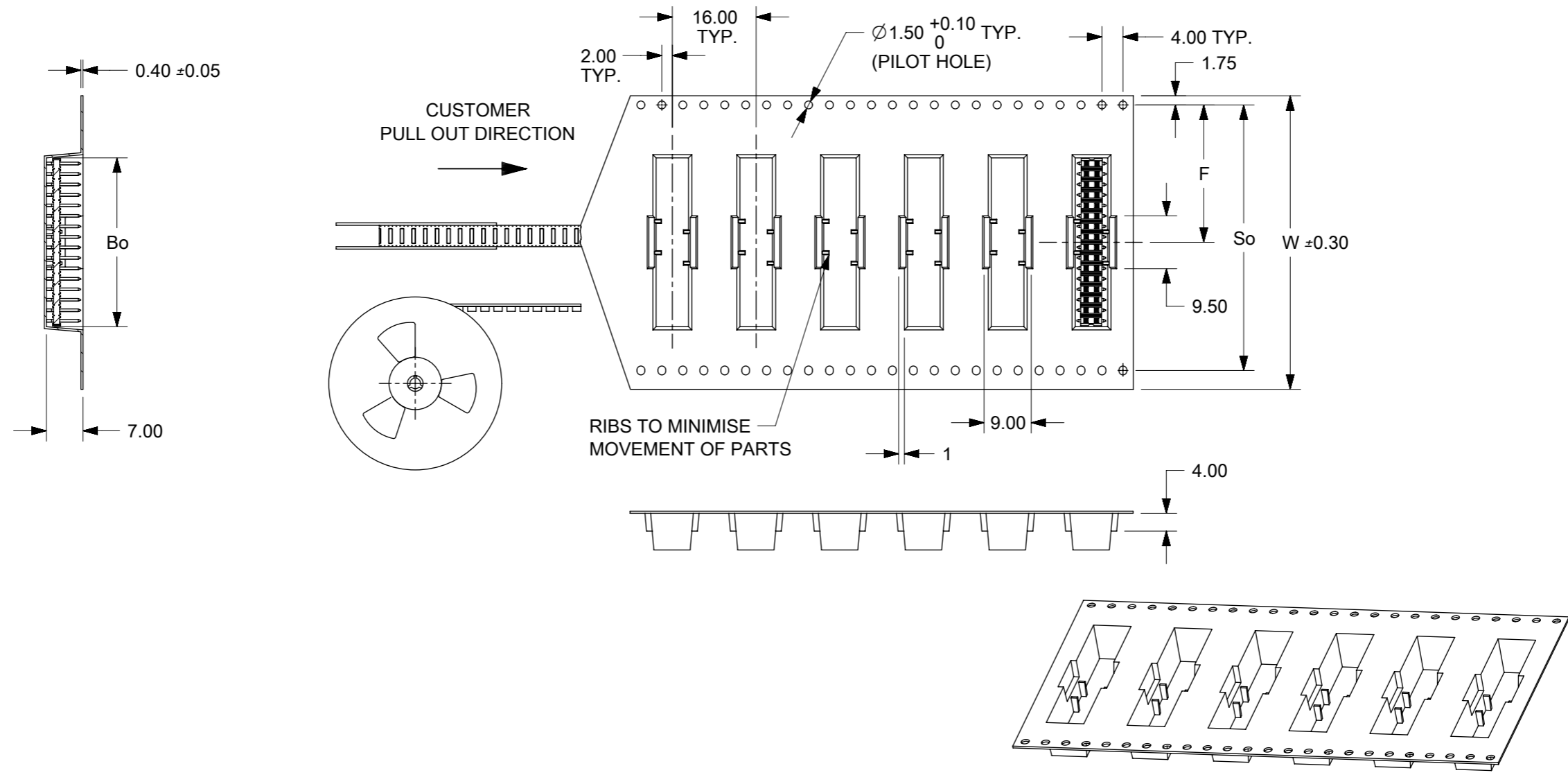

THIS DRAWING CONTAINS INFORMATION THAT IS PROPRIETARY TO MOLEX ELECTRONIC TECHNOLOGIES, LLC AND SHOULD NOT BE USED WITHOUT WRITTEN PERMISSION										
DIMENSION UNITS		SCALE		CURRENT REV DESC: ADD 87759-3279				molex		CUSTOMER MGRID, 2MM DUAL ROW HDR. SMT
mm		NTS								
GENERAL TOLERANCES (UNLESS SPECIFIED)										
		MM	INCH	EC NO: 174700						
4 PLACES	±			DRWN: NVELUSAMY		2017/12/28				
3 PLACES	±			CHK'D: SCS02		2018/04/06				
2 PLACES	±	0.2		APPR: ISHWARG		2018/04/18				
1 PLACE	±			INITIAL REVISION:						
0 PLACES	±			DRWN: KSEE		2003/12/12		DOCUMENT NUMBER		
ANGULAR TOL		± 3.0°		APPR: SKTOH		2004/01/12		SD-87759-117		
DRAFT WHERE APPLICABLE MUST REMAIN WITHIN DIMENSIONS				THIRD ANGLE PROJECTION		DRAWING		SERIES		
						A3-SIZE		87759		
				MATERIAL NUMBER		CUSTOMER		SHEET NUMBER		
				SEE TABLE		GENERAL MARKET		5 OF 8		

DOCUMENT STATUS	P1	RELEASE DATE	2018/04/18	05:28:02
-----------------	----	--------------	------------	----------

EMBOSSED CARRIER TAPE TYPE "C"
 THIS TYPE OF CARRIER IS FOR CKT SIZE 8 AND BELOW.

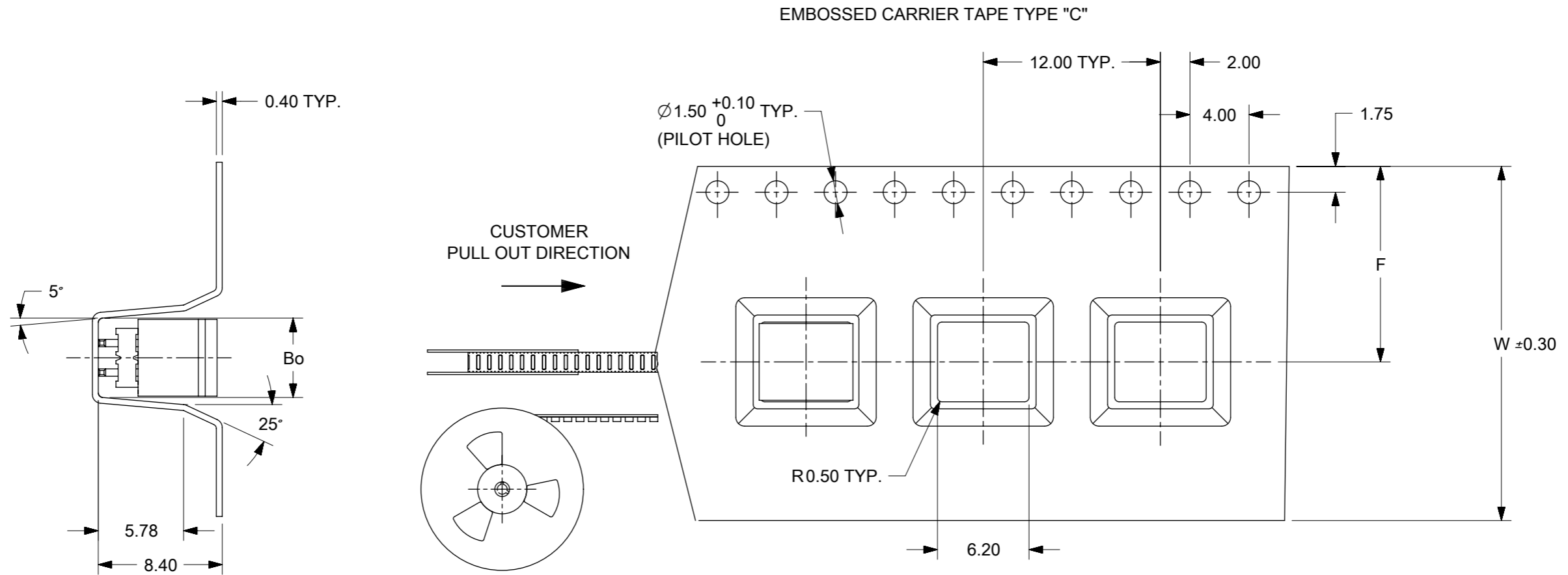

THIS DRAWING CONTAINS INFORMATION THAT IS PROPRIETARY TO MOLEX ELECTRONIC TECHNOLOGIES, LLC AND SHOULD NOT BE USED WITHOUT WRITTEN PERMISSION											
DIMENSION UNITS		SCALE		CURRENT REV DESC: ADD 87759-3279						molex	
mm		NTS									
GENERAL TOLERANCES (UNLESS SPECIFIED)				EC NO: 174700		DRWN: NVELUSAMY		2017/12/28		CUSTOM HEADER	
				CHK'D: SCS02		APPR: ISHWARG		2018/04/06		MGRID, 2MM DUAL ROW HDR. SMT	
				DRWN: KSEE		APPR: SKTOH		2003/12/12		PRODUCT CUSTOMER DRAWING	
				ANGULAR TOL ± 3.0°		INITIAL REVISION:		2004/01/12		DOCUMENT NUMBER	
				DRAFT WHERE APPLICABLE MUST REMAIN WITHIN DIMENSIONS		THIRD ANGLE PROJECTION		DRAWING		DOC TYPE	
						A3-SIZE		SERIES		DOC PART	
						87759		MATERIAL NUMBER		REVISION	
						SEE TABLE		CUSTOMER		SD-87759-117	
						GENERAL MARKET		SHEET NUMBER		PSD 001 B10	
						6 OF 8					

9	8	7	6	5	4	3	2	1								
PART NUMBER WITHOUT CAP IN TRAY	PART NUMBER WITHOUT CAP IN TUBE	PART NUMBER WITH CAP IN TUBE	PART NUMBER WITH CAP IN TAPE AND REEL.	PART NUMBER WITHOUT CAP IN TAPE AND REEL.	CKT SIZE	VOID CKTS	A	B	Bo	F	So	W	EMBOSSSED TYPE	QTY/ REEL	PLATING OPTION	
87759-0414	-	87759-0464	87759-0474	-	4 $\frac{\Delta}{9}$	-	NA	2.00	5.20	11.50	-	24.00	C	750	2	
-	87759-0614	87759-0664	87759-0674	-	6 $\frac{\Delta}{9}$	-	NA	4.00	7.20	11.50	-	24.00	C			
-	87759-0814	87759-0864	87759-0874	-	8	-	7.90	6.00	8.20	11.50	-	24.00	C			
-	87759-1014	87759-1064	87759-1074	-	10	-	9.90	8.00	10.20	11.50	-	24.00	A			
-	87759-1002	87759-1003	87759-1004	-	10	10 $\frac{\Delta}{A}$	9.90	8.00	10.20	11.50	-	24.00	A			
-	87759-1214	87759-1264	87759-1274	-	12	-	11.90	10.00	12.20	11.50	-	24.00	A			
-	87759-1414	87759-1464	87759-1474	-	14	-	13.90	12.00	14.20	11.50	-	24.00	A			
-	87759-1614	87759-1664	87759-1674	-	16	-	15.90	14.00	16.20	14.20	28.40	32.00	B			
-	87759-1814	87759-1864	87759-1874	-	18	-	17.90	16.00	18.20	14.20	28.40	32.00	B			
-	87759-2014	87759-2064	87759-2074	-	20	-	19.90	18.00	20.20	14.20	28.40	32.00	B			
-	87759-2214	87759-2264	87759-2274	-	22	-	21.90	20.00	22.20	20.20	40.40	44.00	B			
-	87759-2414	87759-2464	87759-2474	-	24	-	23.90	22.00	24.20	20.20	40.40	44.00	B			
-	87759-2614	87759-2664	87759-2674	-	26	-	25.90	24.00	26.20	20.20	40.40	44.00	B			
-	87759-2814	87759-2864	87759-2874	-	28	-	27.90	26.00	28.20	20.20	40.40	44.00	B			
-	87759-3014	87759-3064	87759-3074	-	30	-	29.90	28.00	30.20	20.20	40.40	44.00	B			
-	87759-3214	87759-3264	87759-3274	-	32	-	31.90	30.00	32.20	20.20	40.40	56.00	B			
-	-	-	-	B10 87759-3279	32	-	31.90	30.00	32.20	20.20	40.40	46.00	B1			500
-	87759-3414	87759-3464	87759-3474	-	34	-	33.90	32.00	34.20	26.20	52.40	56.00	B			750
-	87759-3614	87759-3664	87759-3674	-	36	-	35.90	34.00	36.20	26.20	52.40	56.00	B	500		
-	-	-	87759-3679	-	36	-	35.90	34.00	36.20	26.20	52.40	56.00	B1			
-	87759-3814	87759-3864	87759-3874	-	38	-	37.90	36.00	38.20	26.20	52.40	56.00	B	750	3	
-	87759-4014	87759-4064	87759-4074	-	40	-	39.90	38.00	40.20	26.20	52.40	56.00	B			
-	87759-4214	87759-4264	87759-4274	-	42	-	41.90	40.00	42.20	26.20	52.40	56.00	B			
-	87759-4414	87759-4464	87759-4474	-	44	-	43.90	42.00	44.20	26.20	52.40	56.00	B			
-	87759-4614	87759-4664	87759-4674	-	46	-	45.90	44.00	46.20	26.20	52.40	56.00	B			
-	87759-4814	87759-4864	87759-4874	-	48	-	47.90	46.00	48.20	26.20	52.40	56.00	B			
-	87759-5014	87759-5064	87759-5074	-	50	-	49.90	48.00	50.20	34.20	68.40	72.00	B			
-	87759-6814	87759-6864	87759-6874	-	8	-	7.90	6.00	8.20	11.50	-	24.00	C			

Δ NOTES:
VOIDED PIN CKT#10

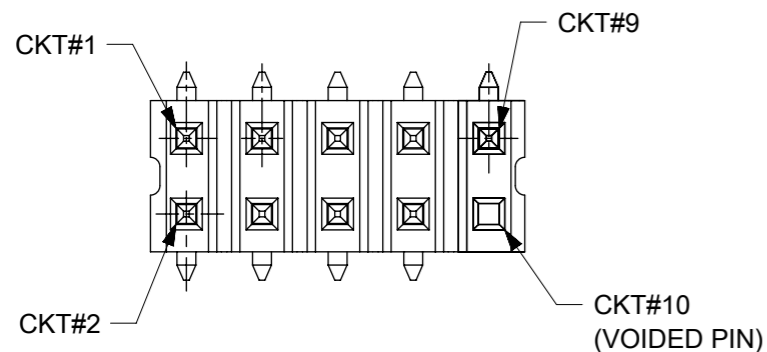

THIS DRAWING CONTAINS INFORMATION THAT IS PROPRIETARY TO MOLEX ELECTRONIC TECHNOLOGIES, LLC AND SHOULD NOT BE USED WITHOUT WRITTEN PERMISSION															
DIMENSION UNITS		SCALE		CURRENT REV DESC: ADD 87759-3279											
mm		NTS		<p>CUSTOM HEADER MGRID, 2MM DUAL ROW HDR. SMT</p> <p>PRODUCT CUSTOMER DRAWING</p>											
GENERAL TOLERANCES (UNLESS SPECIFIED)															
		MM	INCH												
4 PLACES	±		±												
3 PLACES	±		±												
2 PLACES	±	0.2	±												
1 PLACE	±		±												
0 PLACES	±		±												
ANGULAR TOL ± 3.0°				EC NO: 174700		DRWN: NVELUSAMY		2017/12/28		CHK'D: SCS02		2018/04/06			
DRAFT WHERE APPLICABLE MUST REMAIN WITHIN DIMENSIONS				THIRD ANGLE PROJECTION		DRAWING		SERIES		MATERIAL NUMBER		CUSTOMER			
						A3-SIZE		87759		SEE TABLE		GENERAL MARKET			
DOCUMENT STATUS				P1		RELEASE DATE		2018/04/18		05:28:02		SD-87759-117		PSD 001 B10	
FORMAT: Mel-lega-master-ib-prod-A3				REVISION: 0		DATE: 2017/10/08						SHEET NUMBER		7 OF 8	

9	8	7	6	5	4	3	2	1							
PART NUMBER WITHOUT CAP IN TRAY	PART NUMBER WITHOUT CAP IN TUBE	PART NUMBER WITH CAP IN TUBE	PART NUMBER WITH CAP IN TAPE AND REEL.	PART NUMBER WITHOUT CAP IN TAPE AND REEL.	CKT SIZE	VOID CKTS	A	B	Bo	F	So	W	EMBOSSED TYPE	QTY/ REEL	PLATING OPTION
87759-0415	-	87759-0465	87759-0475	-	4 $\frac{\Delta}{9}$	-	3.90 ±0.38	2.00	5.40	11.50	-	24.00	C	750	1
-	87759-0615	87759-0665	87759-0675	-	6 $\frac{\Delta}{9}$	-	5.90 ±0.38	4.00	7.20	11.50	-	24.00	C		
-	87759-0815	87759-0865	87759-0875	-	8	-	7.90	6.00	8.20	11.50	-	24.00	C		
-	87759-1015	87759-1065	87759-1075	-	10	-	9.90	8.00	10.20	11.50	-	24.00	A		
-	87759-1215	87759-1265	87759-1275	-	12	-	11.90	10.00	12.20	11.50	-	24.00	A		
-	87759-1415	87759-1465	87759-1475	-	14	-	13.90	12.00	14.20	11.50	-	24.00	A		
-	87759-1615	87759-1665	87759-1675	-	16	-	15.90	14.00	16.20	14.20	28.40	32.00	B		
-	87759-1815	87759-1865	87759-1875	-	18	-	17.90	16.00	18.20	14.20	28.40	32.00	B		
-	87759-2015	87759-2065	87759-2075	-	20	-	19.90	18.00	20.20	14.20	28.40	32.00	B		
-	87759-2215	87759-2265	87759-2275	-	22	-	21.90	20.00	22.20	20.20	40.40	44.00	B		
-	87759-2415	87759-2465	87759-2475	-	24	-	23.90	22.00	24.20	20.20	40.40	44.00	B		
-	87759-2615	87759-2665	87759-2675	-	26	-	25.90	24.00	26.20	20.20	40.40	44.00	B		
-	87759-2815	87759-2865	87759-2875	-	28	-	27.90	26.00	28.20	20.20	40.40	44.00	B		
-	87759-3015	87759-3065	87759-3075	-	30	-	29.90	28.00	30.20	20.20	40.40	44.00	B		
-	87759-3215	87759-3265	87759-3275	-	32	-	31.90	30.00	32.20	20.20	40.40	44.00	B		
-	87759-3415	87759-3465	87759-3475	-	34	-	33.90	32.00	34.20	26.20	52.40	56.00	B		
-	87759-3615	87759-3665	87759-3675	-	36	-	35.90	34.00	36.20	26.20	52.40	56.00	B		
-	87759-3815	87759-3865	87759-3875	-	38	-	37.90	36.00	38.20	26.20	52.40	56.00	B		
-	87759-4015	87759-4065	87759-4075	-	40	-	39.90	38.00	40.20	26.20	52.40	56.00	B		
-	87759-4215	87759-4265	87759-4275	-	42	-	41.90	40.00	42.20	26.20	52.40	56.00	B		
-	87759-4415	87759-4465	87759-4475	-	44	-	43.90	42.00	44.20	26.20	52.40	56.00	B		
-	87759-4615	87759-4665	87759-4675	-	46	-	45.90	44.00	46.20	26.20	52.40	56.00	B		
-	87759-4815	87759-4865	87759-4875	-	48	-	47.90	46.00	48.20	26.20	52.40	56.00	B		
-	87759-5015	87759-5065	87759-5075	-	50	-	49.90	48.00	50.20	34.20	68.40	72.00	B		

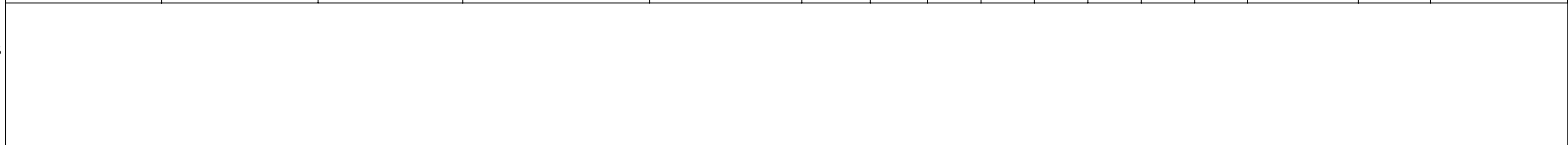

THIS DRAWING CONTAINS INFORMATION THAT IS PROPRIETARY TO MOLEX ELECTRONIC TECHNOLOGIES, LLC AND SHOULD NOT BE USED WITHOUT WRITTEN PERMISSION																	
DIMENSION UNITS		SCALE		CURRENT REV DESC: ADD 87759-3279													
mm		NTS															
GENERAL TOLERANCES (UNLESS SPECIFIED)																	
		MM	INCH	EC NO: 174700 DRWN: NVELUSAMY 2017/12/28 CHK'D: SCS02 2018/04/06 APPR: ISHWARG 2018/04/18													
4 PLACES	±																
3 PLACES	±																
2 PLACES	±	0.2															
1 PLACE	±																
0 PLACES	±																
ANGULAR TOL		± 3.0°		INITIAL REVISION: DRWN: KSEE 2003/12/12 APPR: SKTOH 2004/01/12													
DRAFT WHERE APPLICABLE MUST REMAIN WITHIN DIMENSIONS																	
THIRD ANGLE PROJECTION		DRAWING		SERIES		MATERIAL NUMBER		CUSTOMER		DOCUMENT NUMBER		DOC TYPE		DOC PART		REVISION	
		A3-SIZE		87759		SEE TABLE		GENERAL MARKET		SD-87759-117		PSD		001		B10	
DOCUMENT STATUS		P1		RELEASE DATE		2018/04/18		05:28:02									

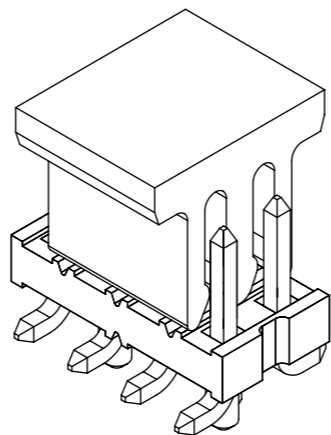
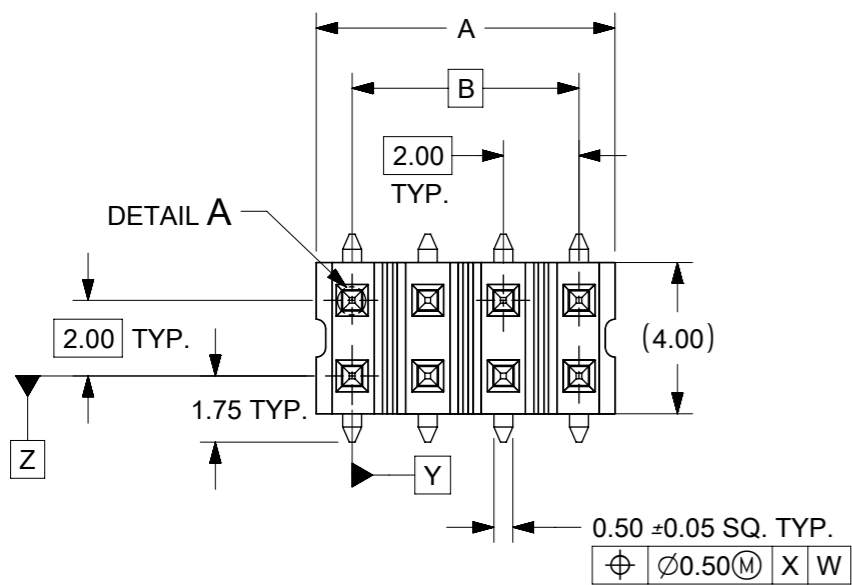

NOTES:

- MATERIAL:
HOUSING: NYLON, GLASS-FILLED, UL94V-0,
COLOR: BLACK
PIN: 0.50mm SQ. COPPER ALLOY
- PLATING FINISH:
 - 15µin MIN. GOLD PLATE IN SELECTED AREA AND 80µin MIN. TIN ON SOLDER TAIL OVER 50µin MIN. NICKEL UNDERPLATE OVERALL.
 - 30µin MIN. GOLD PLATE IN SELECTED AREA AND 80µin MIN. TIN ON SOLDER TAIL OVER 50µin MIN. NICKEL UNDERPLATE OVERALL.
 - 100µin MIN. TIN OVERALL 50µin MIN. NICKEL UNDERPLATE OVERALL.
 - 2-10µin MIN. GOLD OVER 50µin MIN. NICKEL UNDERPLATE OVERALL.
- PACKAGING: SEE TABLE
- RECOMMENDED PCB THICKNESS: 1.60±0.10mm
- PRODUCT SPECIFICATION: PS-87761-100
- WAFER TO BE FLAT WITHIN 0.003mm/mm
- BEND DEPRESSION IS ACCEPTED SO LONG AS IT DOES NOT AFFECT THE OVERALL COPLANARITY OF TAIL
- COPLANARITY IS TO BE MEASURED BY RESTING THE SOLDER TAIL ON A FLAT SURFACE
- CAP LOCATION IS CENTERED ALONG THE MATING ENDS AS SHOWN. TOP SURFACE OF CAP TO BE FLAT FOR THE PURPOSE OF PICK & PLACE BY VACUUM SUCTION NOZZLE
- CKT 4 & 6 IS CUT FROM CKT 8 & 12 RESPECTIVELY. ROUGH EDGES ARE EXPECTED ALONG THE CUTTING EDGES
- THE ABOVE 8CKTS SHOWN IS FOR ILLUSTRATION ONLY.
- TUBE LENGTH : 560mm REF.

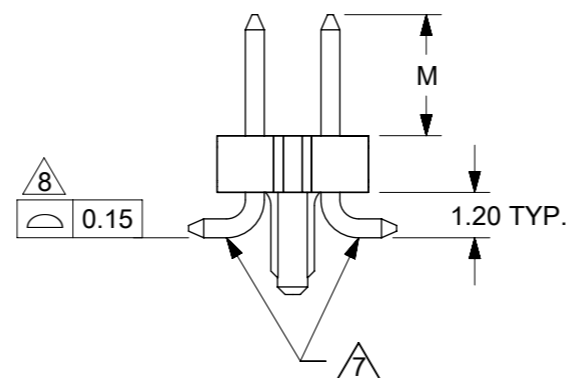
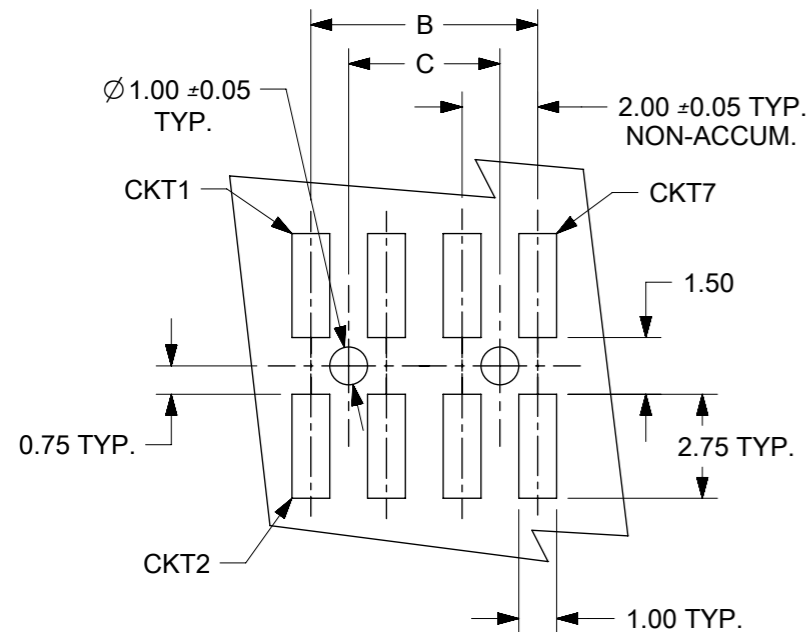
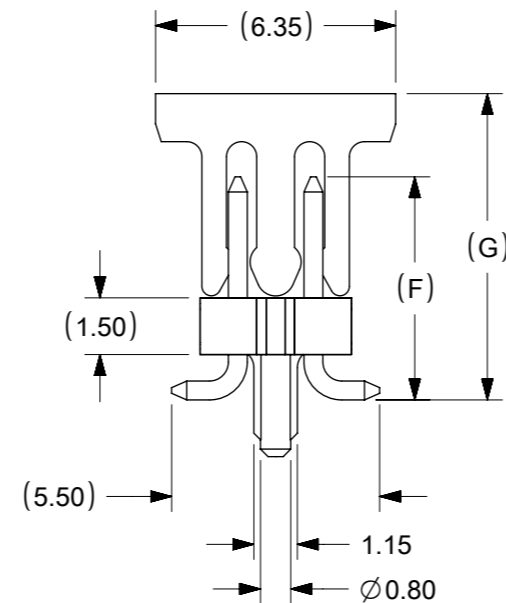
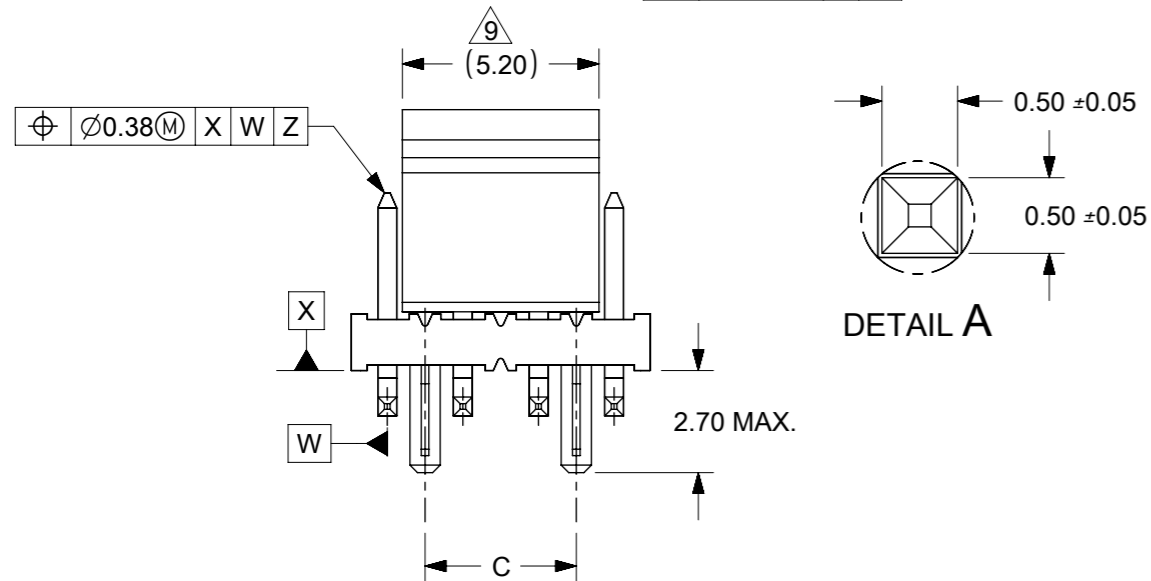

SYMBOLS	THIS DRAWING CONTAINS INFORMATION THAT IS PROPRIETARY TO MOLEX ELECTRONIC TECHNOLOGIES, LLC AND SHOULD NOT BE USED WITHOUT WRITTEN PERMISSION		CURRENT REV DESC: REMASTERED IN NX		
	DIMENSION UNITS	SCALE			
▽ = 0	mm	NTS			2.00MM PITCH DUAL ROW HDR, SINGLE WAFER, SMT
▽ = 0	GENERAL TOLERANCES (UNLESS SPECIFIED)				PRODUCT CUSTOMER DRAWING
▽ = 0		MM	INCH		
▽ = 0	4 PLACES ±				DOCUMENT NUMBER
▽ = 0	3 PLACES ±				DOC TYPE
▽ = 0	2 PLACES ±	0.2			DOC PART
▽ = 0	1 PLACE ±				REVISION
▽ = 0	0 PLACES ±				SD-87759-277
▽ = 0	ANGULAR TOL ±	3.0°			PSD
▽ = 0	DRAFT WHERE APPLICABLE MUST REMAIN WITHIN DIMENSIONS				001
▽ = 0					B3
	THIRD ANGLE PROJECTION	DRAWING	SERIES	MATERIAL NUMBER	CUSTOMER
		A3-SIZE	87759	SEE TABLE	GENERAL MARKET
					SHEET NUMBER
					1 OF 12

PARTS PACK IN
TUBE ORIENTATION

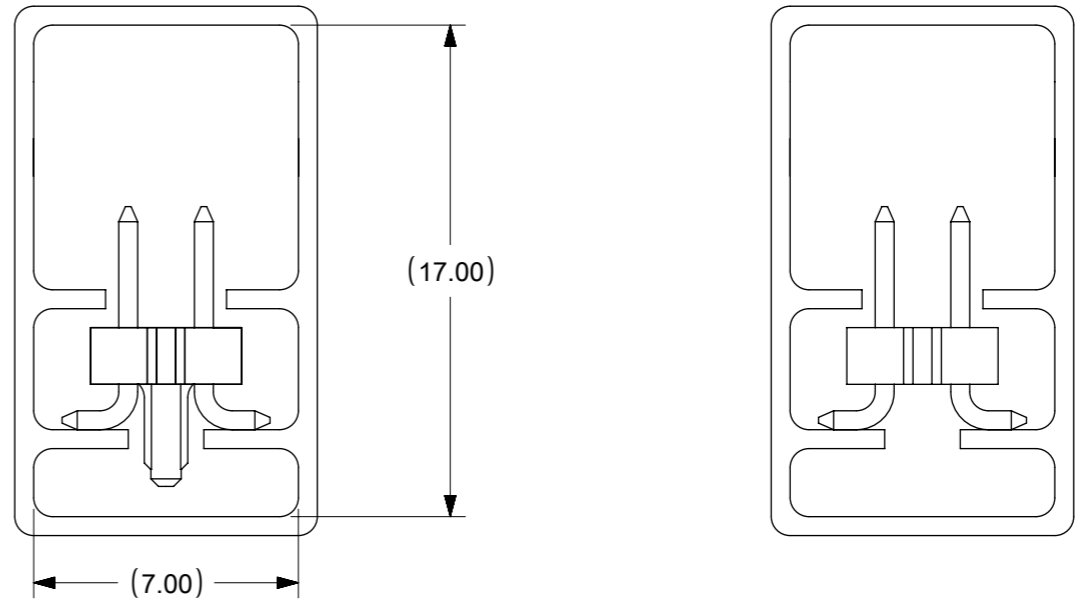

PART WITHOUT CAP IN TUBE
(PLS REFER TO PK SPEC: PK-89990-475)

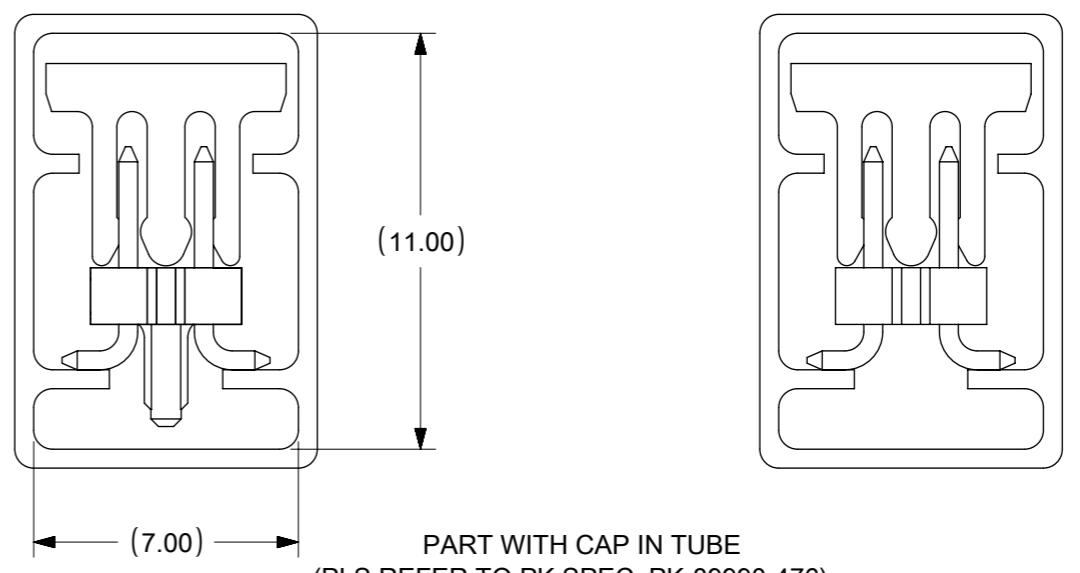

PART WITH CAP IN TUBE
(PLS REFER TO PK SPEC: PK-89990-476)

CIRCUITS POSITION
CONFIGURATION

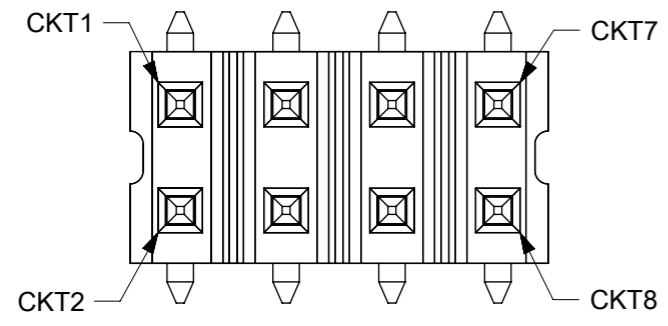

THIS DRAWING CONTAINS INFORMATION THAT IS PROPRIETARY TO MOLEX ELECTRONIC TECHNOLOGIES, LLC AND SHOULD NOT BE USED WITHOUT WRITTEN PERMISSION										
SYMBOLS	DIMENSION UNITS		SCALE		CURRENT REV DESC: REMASTERED IN NX					
	$\nabla = 0$	mm	NTS		molex CUSTOM HEADER 2.00MM PITCH DUAL ROW HDR, SINGLE WAFER, SMT					
$\nabla = 0$	GENERAL TOLERANCES (UNLESS SPECIFIED)									
$\nabla = 0$			MM	INCH	EC NO: 614469					
$\nabla = 0$	4 PLACES	±			DRWN: GJEEVANSURES 2019/02/12					
$\nabla = 0$	3 PLACES	±			CHK'D: GJEEVANSURES 2019/04/10					
$\nabla = 0$	2 PLACES	±	0.2		APPR: ISHWARG 2019/04/15					
$\nabla = 0$	1 PLACE	±			INITIAL REVISION:					
$\nabla = 0$	0 PLACES	±			DRWN: SKLIM01 2006/03/23					
$\nabla = 0$	ANGULAR TOL		±	3.0°	APPR: PATEY 2006/03/29					
$\nabla = 0$	DRAFT WHERE APPLICABLE MUST REMAIN WITHIN DIMENSIONS				THIRD ANGLE PROJECTION	DRAWING	SERIES	MATERIAL NUMBER	CUSTOMER	SHEET NUMBER
$\nabla = 0$						A3-SIZE	87759	SEE TABLE	GENERAL MARKET	2 OF 12

WITH CAP IN TAPE & REEL PACKAGING
 THE 8CKTS SHOWN AS ABOVE IS FOR
 ILLUSTRATION PURPOSE ONLY.
 (THIS TYPE E/TAPE USED FOR CKT 8 TO 14)
 (PLS REFER TO PK SPEC: PK-89990-484)

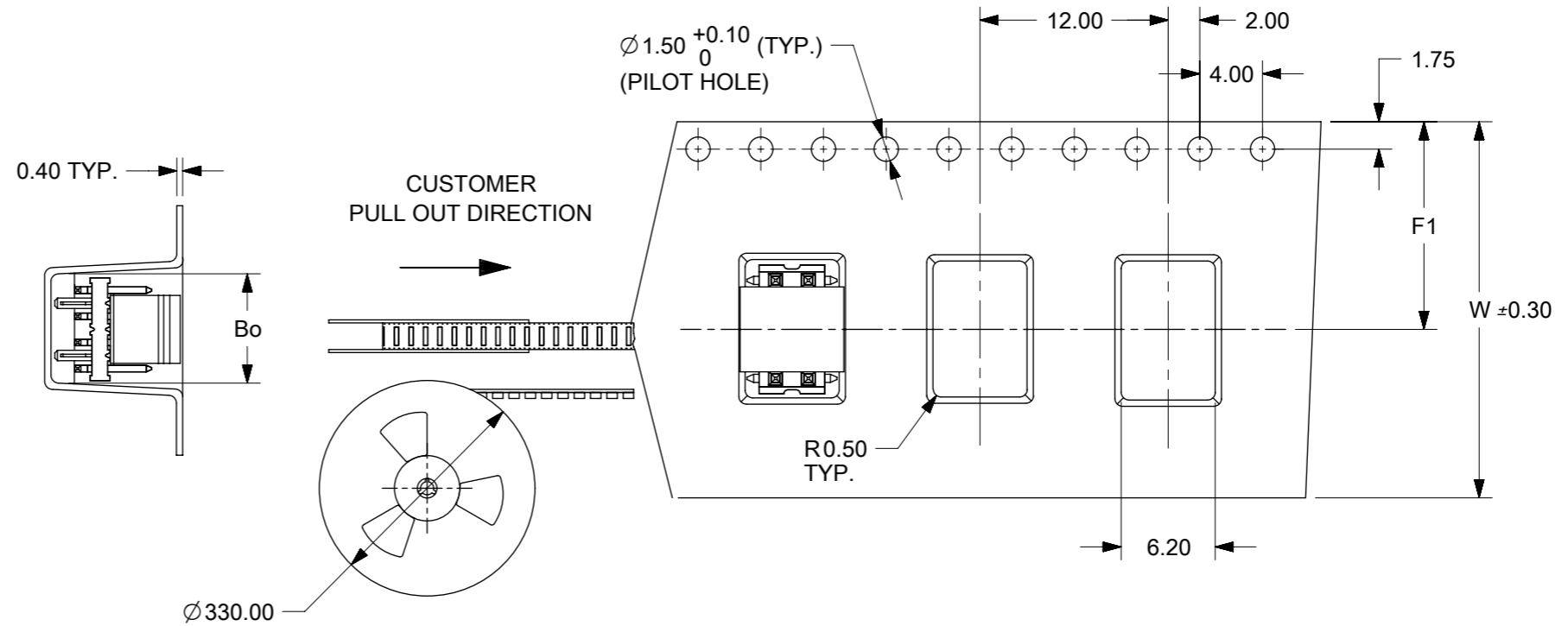

EMBOSSSED CARRIER TAPE TYPE "A"

NOTES:

1. LEADER AND TRAILER TAPE

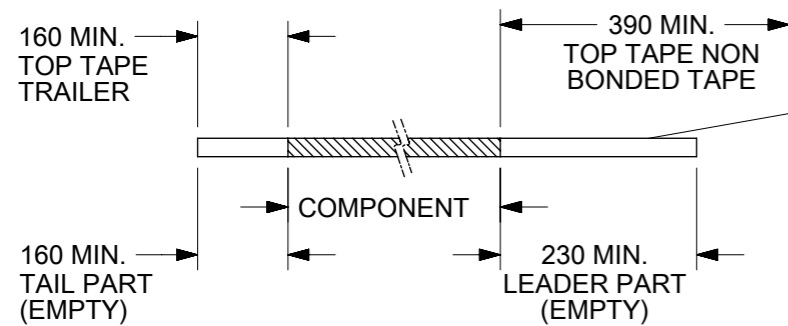

PULL OUT DIRECTION

**2. PEELING OFF FORCE OF THE TOP TAPE: 20 - 80gf.
 (PEELING DIRECTION AS SHOWN IN FOLLOWING FIGURE)**

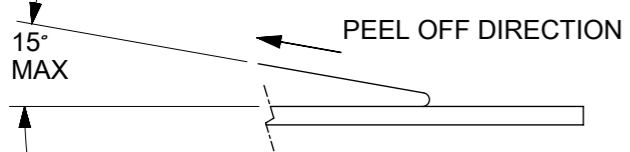

PULL OUT DIRECTION

- 3. TAPE & REEL SPECIFICATION IS AS PER EIA-481.
- 4. TAPE & REEL QUANTITY = 500 PCS/REEL
- 5. THE TAPE IS TREATED FOR ANTI-STATIC

SYMBOLS	THIS DRAWING CONTAINS INFORMATION THAT IS PROPRIETARY TO MOLEX ELECTRONIC TECHNOLOGIES, LLC AND SHOULD NOT BE USED WITHOUT WRITTEN PERMISSION		CURRENT REV DESC: REMASTERED IN NX		molex
	DIMENSION UNITS	SCALE			
▽ = 0	mm	NTS			2.00MM PITCH DUAL ROW HDR, SINGLE WAFER, SMT
▽ = 0	GENERAL TOLERANCES (UNLESS SPECIFIED)				PRODUCT CUSTOMER DRAWING
▽ = 0					
▽ = 0	4 PLACES	±			DOCUMENT NUMBER
▽ = 0	3 PLACES	±			
▽ = 0	2 PLACES	±	0.2		SD-87759-277
▽ = 0	1 PLACE	±			
▽ = 0	0 PLACES	±			DOC TYPE
□ = 0	ANGULAR TOL ± 3.0°				DOC PART
■ = 0	DRAFT WHERE APPLICABLE MUST REMAIN WITHIN DIMENSIONS		THIRD ANGLE PROJECTION	DRAWING	REVISION
▽ = 0				SERIES	
				MATERIAL NUMBER	CUSTOMER
				SEE TABLE	GENERAL MARKET
					SHEET NUMBER
					3 OF 12

WITH CAP IN TAPE & REEL PACKAGING
 THE 24CKTS SHOWN ABOVE
 IS FOR ILLUSTRATION ONLY.
 (THIS TYPE E/TAPE USED FOR CKT 16 TO 50)
 (PLS REFER TO PK SPEC: PK-89990-484)

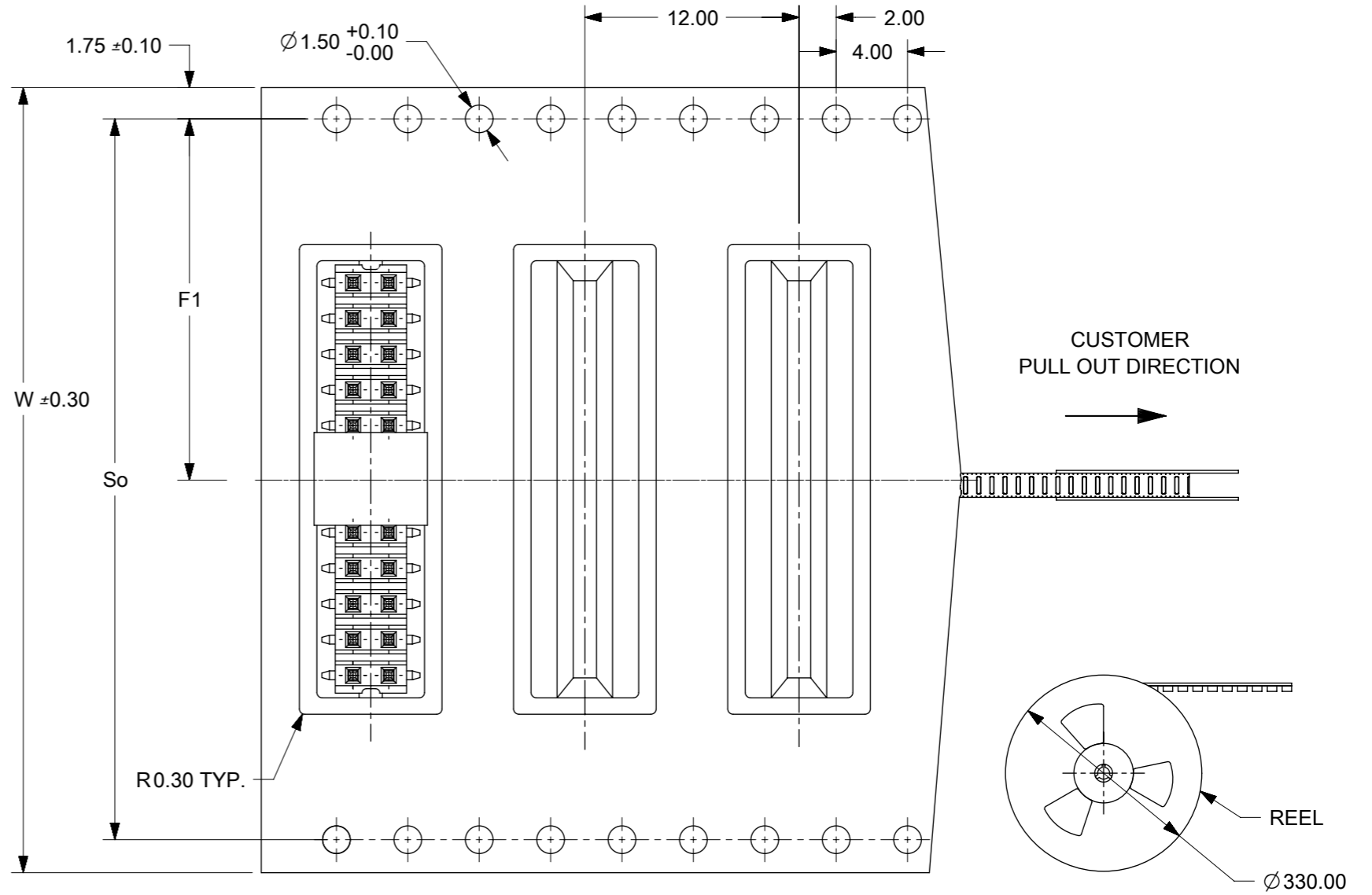
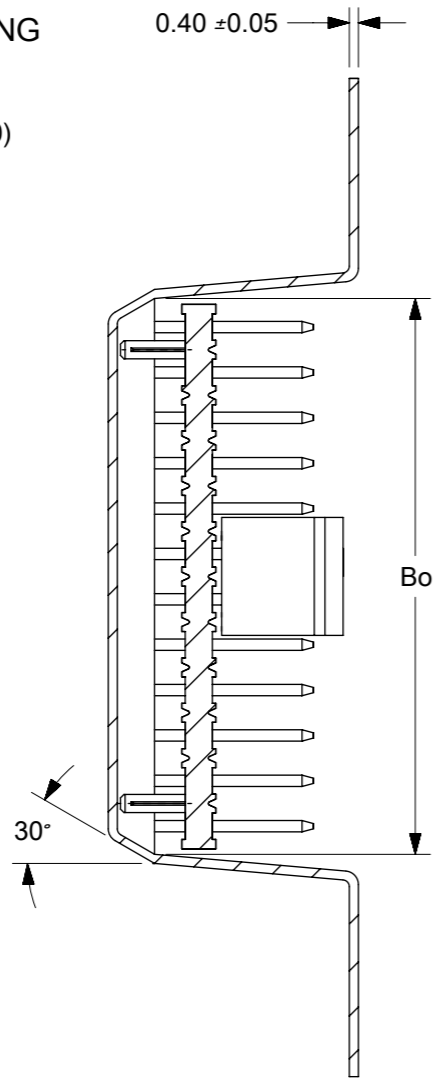

EMBOSSED CARRIER TAPE TYPE "B"

- NOTES:
 1. LEADER AND TRAILER TAPE

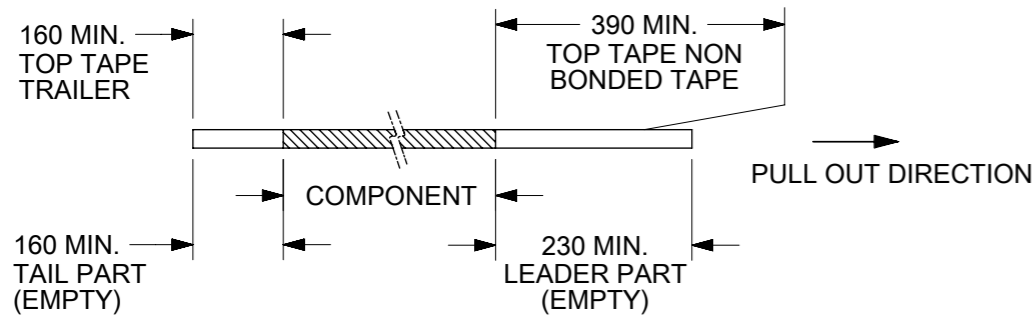

2. PEELING OFF FORCE OF THE TOP TAPE: 20 - 80gf.
 (PEELING DIRECTION AS SHOWN IN FOLLOWING FIGURE)

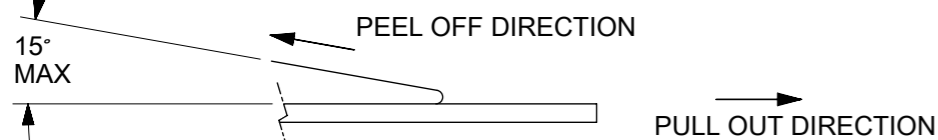

3. TAPE & REEL SPECIFICATION IS AS PER EIA-481.
 4. TAPE & REEL QUANTITY = 500 PCS/REEL
 5. THE TAPE IS TREATED FOR ANTI-STATIC

SYMBOLS		THIS DRAWING CONTAINS INFORMATION THAT IS PROPRIETARY TO MOLEX ELECTRONIC TECHNOLOGIES, LLC AND SHOULD NOT BE USED WITHOUT WRITTEN PERMISSION		CURRENT REV DESC: REMASTERED IN NX	
▽ = 0	mm	SCALE		N/A	
▽ = 0	NTS	GENERAL TOLERANCES (UNLESS SPECIFIED)		molex	
▽ = 0		MM	INCH	CUSTOM HEADER	
▽ = 0	4 PLACES ±			2.00MM PITCH DUAL ROW HDR, SINGLE WAFER, SMT	
▽ = 0	3 PLACES ±			PRODUCT CUSTOMER DRAWING	
▽ = 0	2 PLACES ± 0.2 ±			DOCUMENT NUMBER	
▽ = 0	1 PLACE ±			SD-87759-277	
▽ = 0	0 PLACES ±			DOC TYPE	
▽ = 0	ANGULAR TOL ± 3.0°			PSD	
■ = 0	DRAFT WHERE APPLICABLE MUST REMAIN WITHIN DIMENSIONS	THIRD ANGLE PROJECTION		DOC PART	
▽ = 0		DRAWING		REVISION	
		A3-SIZE		001	
		SERIES		B3	
		87759		MATERIAL NUMBER	
		SEE TABLE		CUSTOMER	
		GENERAL MARKET		SHEET NUMBER	
		4 OF 12			

10	9	8	7	6	5	4	3	2	1										
PART NUMBER WITHOUT CAP IN TRAY	PART NUMBER WITHOUT CAP IN TUBE	PART NUMBER WITH CAP IN TUBE	PART NUMBER WITH CAP IN TAPE & REEL	CKT SIZE	PEG	PLATING TYPE	VOID POSITION	A	B	C	M	(F)	(G)	Bo	F1	So	W	EMBOSSSED TYPE	
F	87759-0461	----	----	4	N	1	----	3.90	2.00	---	3.20	5.90	8.10	---	---	---	---	---	
	87759-0462	----	----	4	N	2	----	3.90	2.00	---	3.20	5.90	8.10	---	---	---	---	---	
	87759-0463	----	87759-0493	4	N	3	----	3.90	2.00	---	3.20	5.90	8.10	---	---	---	---	---	
	87759-0661	----	----	6	N	1	----	7.90	6.00	---	3.20	5.90	8.10	---	---	---	---	---	
E	87759-0662	----	----	6	N	2	----	7.90	6.00	---	3.20	5.90	8.10	---	---	---	---	---	
	87759-0663	----	----	6	N	3	----	7.90	6.00	---	3.20	5.90	8.10	---	---	---	---	---	
	----	87759-0861	87759-0871	87759-0881	8	N	1	----	7.90	6.00	---	3.20	5.90	8.10	8.50	11.50	---	24.00	A
	----	87759-0862	87759-0872	87759-0882	8	N	2	----	7.90	6.00	---	3.20	5.90	8.10	8.50	11.50	---	24.00	A
	----	87759-0863	87759-0873	87759-0883	8	N	3	----	7.90	6.00	---	3.20	5.90	8.10	8.50	11.50	---	24.00	A
D	----	87759-6081	87759-7081	87759-8081	8	Y	1	----	7.90	6.00	4.00	3.20	5.90	8.10	8.50	11.50	---	24.00	A
	----	87759-6082	87759-7082	87759-8082	8	Y	2	----	7.90	6.00	4.00	3.20	5.90	8.10	8.50	11.50	---	24.00	A
	----	87759-6083	87759-7083	87759-8083	8	Y	3	----	7.90	6.00	4.00	3.20	5.90	8.10	8.50	11.50	---	24.00	A

10	9	8	7	6	5	4	3	2	1
C									
B									
A									

SYMBOLS									
▽ = 0	mm	NTS	CURRENT REV DESC: REMASTERED IN NX						
▽ = 0	GENERAL TOLERANCES (UNLESS SPECIFIED)		molex CUSTOM HEADER 2.00MM PITCH DUAL ROW HDR, SINGLE WAFER, SMT PRODUCT CUSTOMER DRAWING						
▽ = 0	MM	INCH							
▽ = 0	4 PLACES ±	±							
▽ = 0	3 PLACES ±	±							
▽ = 0	2 PLACES ±	0.2 ±							
▽ = 0	1 PLACE ±	±	EC NO: 614469 DRWN: GJEEVANSURES 2019/02/12 CHK'D: GJEEVANSURES 2019/04/10 APPR: ISHWARG 2019/04/15 INITIAL REVISION: DRWN: SKLIM01 2006/03/23 APPR: PATEY 2006/03/29						
☒ = 0	ANGULAR TOL ±	3.0°	DOCUMENT NUMBER		DOC TYPE	DOC PART	REVISION	SD-87759-277 PSD 001 B3	
■ = 0	DRAFT WHERE APPLICABLE MUST REMAIN WITHIN DIMENSIONS		THIRD ANGLE PROJECTION		DRAWING	SERIES	MATERIAL NUMBER	CUSTOMER	SHEET NUMBER
▽ = 0					A3-SIZE	87759	SEE TABLE	GENERAL MARKET	5 OF 12

DOCUMENT STATUS P1 RELEASE DATE 2019/04/15 06:29:54

10	9	8	7	6	5	4	3	2	1										
PART NUMBER WITHOUT CAP IN TUBE	PART NUMBER WITH CAP IN TUBE	PART NUMBER WITH CAP IN TAPE & REEL	PART NUMBER WITHOUT CAP IN TRAY	CKT SIZE	PEG	PLATING TYPE	VOID POSITION	A	B	C	M	(F)	(G)	Bo	F1	So	W	EMBOSSED TYPE	
F	87759-1061	87759-1071	87759-1081	-----	10	N	1	-----	9.90	8.00	---	3.20	5.90	8.10	10.50	11.50	---	24.00	A
	87759-1062	87759-1072	87759-1082	-----	10	N	2	-----	9.90	8.00	---	3.20	5.90	8.10	10.50	11.50	---	24.00	A
	87759-1063	87759-1073	87759-1083	-----	10	N	3	-----	9.90	8.00	---	3.20	5.90	8.10	10.50	11.50	---	24.00	A
	87759-6101	87759-7101	87759-8101	-----	10	Y	1	-----	9.90	8.00	6.00	3.20	5.90	8.10	10.50	11.50	---	24.00	A
	87759-6102	87759-7102	87759-8102	-----	10	Y	2	-----	9.90	8.00	6.00	3.20	5.90	8.10	10.50	11.50	---	24.00	A
E	87759-6103	87759-7103	87759-8103	-----	10	Y	3	-----	9.90	8.00	6.00	3.20	5.90	8.10	10.50	11.50	---	24.00	A
	87759-1070	87759-7030	87759-7010	-----	10	Y	1	----	9.90	8.00	6.00	3.60	6.50	8.70	10.50	11.50	---	24.00	A
	87759-1261	87759-1271	87759-1281	-----	12	N	1	-----	11.90	10.00	---	3.20	5.90	8.10	12.50	11.50	---	24.00	A
	87759-1262	87759-1272	87759-1282	-----	12	N	2	-----	11.90	10.00	---	3.20	5.90	8.10	12.50	11.50	---	24.00	A
	87759-1263	87759-1273	87759-1283	-----	12	N	3	-----	11.90	10.00	---	3.20	5.90	8.10	12.50	11.50	---	24.00	A
D	87759-6121	87759-7121	87759-8121	-----	12	Y	1	-----	11.90	10.00	---	3.20	5.90	8.10	12.50	11.50	---	24.00	A
	87759-6122	87759-7122	87759-8122	-----	12	Y	2	-----	11.90	10.00	---	3.20	5.90	8.10	12.50	11.50	---	24.00	A
	87759-6123	87759-7123	87759-8123	-----	12	Y	3	-----	11.90	10.00	---	3.20	5.90	8.10	12.50	11.50	---	24.00	A
	----	----	----	87759-0005	12	N	4	----	11.90	10.00	---	4.57	7.57	---	---	---	---	---	---
C	87759-1461	87759-1471	87759-1481	-----	14	N	1	-----	13.90	12.00	---	3.20	5.90	8.10	14.50	11.50	---	24.00	A
	87759-1462	87759-1472	87759-1482	-----	14	N	2	-----	13.90	12.00	---	3.20	5.90	8.10	14.50	11.50	---	24.00	A
	87759-1463	87759-1473	87759-1483	-----	14	N	3	-----	13.90	12.00	---	3.20	5.90	8.10	14.50	11.50	---	24.00	A
	87759-6141	87759-7141	87759-8141	-----	14	Y	1	-----	13.90	12.00	---	3.20	5.90	8.10	14.50	11.50	---	24.00	A
	87759-6142	87759-7142	87759-8142	-----	14	Y	2	-----	13.90	12.00	---	3.20	5.90	8.10	14.50	11.50	---	24.00	A
	87759-6143	87759-7143	87759-8143	-----	14	Y	3	-----	13.90	12.00	---	3.20	5.90	8.10	14.50	11.50	---	24.00	A
B	----	----	87759-0003	-----	14	Y	1	-----	13.90	12.00	---	4.00	6.70	8.05	14.20	11.50	---	24.00	A
	87759-1470	87759-7032	87759-7012	-----	14	Y	1	----	13.90	12.00	6.00	3.60	6.50	8.70	14.50	11.50	---	24.00	A

<p>SYMBOLS</p> <p>▽ = 0</p> <p>▽ = 0</p> <p>▽ = 0</p> <p>▽ = 0</p> <p>▽ = 0</p> <p>▽ = 0</p> <p>▽ = 0</p> <p>▽ = 0</p> <p>▽ = 0</p> <p>▽ = 0</p>										<p>THIS DRAWING CONTAINS INFORMATION THAT IS PROPRIETARY TO MOLEX ELECTRONIC TECHNOLOGIES, LLC AND SHOULD NOT BE USED WITHOUT WRITTEN PERMISSION</p> <p>DIMENSION UNITS: mm</p> <p>SCALE: NTS</p> <p>GENERAL TOLERANCES (UNLESS SPECIFIED)</p> <table border="1"> <tr> <th></th> <th>MM</th> <th>INCH</th> </tr> <tr> <td>4 PLACES</td> <td>±</td> <td>±</td> </tr> <tr> <td>3 PLACES</td> <td>±</td> <td>±</td> </tr> <tr> <td>2 PLACES</td> <td>± 0.2</td> <td>±</td> </tr> <tr> <td>1 PLACE</td> <td>±</td> <td>±</td> </tr> <tr> <td>0 PLACES</td> <td>±</td> <td>±</td> </tr> <tr> <td>ANGULAR TOL</td> <td colspan="2">± 3.0°</td> </tr> </table> <p>DRAFT WHERE APPLICABLE MUST REMAIN WITHIN DIMENSIONS</p>											MM	INCH	4 PLACES	±	±	3 PLACES	±	±	2 PLACES	± 0.2	±	1 PLACE	±	±	0 PLACES	±	±	ANGULAR TOL	± 3.0°		<p>CURRENT REV DESC: REMASTERED IN NX</p> <p>EC NO: 614469</p> <p>DRWN: GJEEVANSURES 2019/02/12</p> <p>CHK'D: GJEEVANSURES 2019/04/10</p> <p>APPR: ISHWARG 2019/04/15</p> <p>INITIAL REVISION:</p> <p>DRWN: SKLIM01 2006/03/23</p> <p>APPR: PATEY 2006/03/29</p> <p>THIRD ANGLE PROJECTION</p> <p>DRAWING: A3-SIZE</p> <p>SERIES: 87759</p>										<p>molex</p> <p>CUSTOM HEADER</p> <p>2.00MM PITCH DUAL ROW HDR, SINGLE WAFER, SMT</p> <p>PRODUCT CUSTOMER DRAWING</p> <p>DOCUMENT NUMBER: SD-87759-277</p> <p>DOC TYPE: PSD</p> <p>DOC PART: 001</p> <p>REVISION: B3</p> <p>MATERIAL NUMBER: SEE TABLE</p> <p>CUSTOMER: GENERAL MARKET</p> <p>SHEET NUMBER: 6 OF 12</p>									
	MM	INCH																																																										
4 PLACES	±	±																																																										
3 PLACES	±	±																																																										
2 PLACES	± 0.2	±																																																										
1 PLACE	±	±																																																										
0 PLACES	±	±																																																										
ANGULAR TOL	± 3.0°																																																											
<p>DOCUMENT STATUS: P1</p> <p>RELEASE DATE: 2019/04/15 06:29:54</p>																																																												

10	9	8	7	6	5	4	3	2	1									
PART NUMBER WITHOUT CAP IN TUBE	PART NUMBER WITH CAP IN TUBE	PART NUMBER WITH CAP IN TAPE & REEL	CKT SIZE	PEG	PLATING TYPE	VOID POSITION	A	B	C	M	(F)	(G)	Bo	F1	So	W	EMBOSSED TYPE	
F	87759-1661	87759-1671	87759-1681	16	N	1	----	15.90	14.00	---	3.20	5.90	8.10	16.50	14.20	28.40	32.00	B
	87759-1662	87759-1672	87759-1682	16	N	2	----	15.90	14.00	---	3.20	5.90	8.10	16.50	14.20	28.40	32.00	B
	87759-1663	87759-1673	87759-1683	16	N	3	----	15.90	14.00	---	3.20	5.90	8.10	16.50	14.20	28.40	32.00	B
	87759-6161	87759-7161	87759-8161	16	Y	1	----	15.90	14.00	---	3.20	5.90	8.10	16.50	14.20	28.40	32.00	B
	87759-6162	87759-7162	87759-8162	16	Y	2	----	15.90	14.00	---	3.20	5.90	8.10	16.50	14.20	28.40	32.00	B
E	87759-6163	87759-7163	87759-8163	16	Y	3	----	15.90	14.00	---	3.20	5.90	8.10	16.50	14.20	28.40	32.00	B
	87759-1611	87759-1612	87759-1613	16	N	4	----	15.90	14.00	---	5.50	8.20	9.60	16.50	14.20	28.40	32.00	B
	87759-1670	87759-7033	87759-7013	16	Y	1	----	15.90	14.00	12.20	3.60	6.50	8.70	16.50	16.50	28.40	28.40	B
	87759-6737	877596707	87759-1667	16	Y	1	----	15.90	14.00	12.00	6.80	9.50	10.83	16.40	14.20	28.40	32.00	B
D	87759-1861	87759-1871	87759-1881	18	N	1	----	17.90	16.00	---	3.20	5.90	8.10	18.50	14.20	28.40	32.00	B
	87759-1862	87759-1872	87759-1882	18	N	2	----	17.90	16.00	---	3.20	5.90	8.10	18.50	14.20	28.40	32.00	B
	87759-1863	87759-1873	87759-1883	18	N	3	----	17.90	16.00	---	3.20	5.90	8.10	18.50	14.20	28.40	32.00	B
	87759-6181	87759-7181	87759-8181	18	Y	1	----	17.90	16.00	---	3.20	5.90	8.10	18.50	14.20	28.40	32.00	B
	87759-6182	87759-7182	87759-8182	18	Y	2	----	17.90	16.00	---	3.20	5.90	8.10	18.50	14.20	28.40	32.00	B
	87759-6183	87759-7183	87759-8183	18	Y	3	----	17.90	16.00	---	3.20	5.90	8.10	18.50	14.20	28.40	32.00	B
C	----	87759-0002	87759-0001	18	Y	1	----	17.90	16.00	14.00	10.30	13.00	14.31	18.40	20.20	40.40	44.00	B
		87759-1820		18	N	4	---	17.90	16.00	---	8.40	11.10	12.47	18.40	20.20	40.40	44.00	B
	87759-2061	87759-2071	87759-2081	20	N	1	----	19.90	18.00	---	3.20	5.90	8.10	20.50	20.20	40.40	44.00	B
	87759-2062	87759-2072	87759-2082	20	N	2	----	19.90	18.00	---	3.20	5.90	8.10	20.50	20.20	40.40	44.00	B
	87759-2063	87759-2073	87759-2083	20	N	3	----	19.90	18.00	---	3.20	5.90	8.10	20.50	20.20	40.40	44.00	B
B	87759-6201	87759-7201	87759-8201	20	Y	1	----	19.90	18.00	---	3.20	5.90	8.10	20.50	20.20	40.40	44.00	B
	87759-6202	87759-7202	87759-8202	20	Y	2	----	19.90	18.00	---	3.20	5.90	8.10	20.50	20.20	40.40	44.00	B

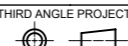
SYMBOLS	THIS DRAWING CONTAINS INFORMATION THAT IS PROPRIETARY TO MOLEX ELECTRONIC TECHNOLOGIES, LLC AND SHOULD NOT BE USED WITHOUT WRITTEN PERMISSION									
	DIMENSION UNITS		SCALE		CURRENT REV DESC: REMASTERED IN NX					
	mm		NTS		 CUSTOM HEADER 2.00MM PITCH DUAL ROW HDR, SINGLE WAFER, SMT					
	GENERAL TOLERANCES (UNLESS SPECIFIED)									
	4 PLACES ±		MM		INCH		EC NO: 614469			
3 PLACES ±						DRWN: GJEEVANSURES 2019/02/12				
2 PLACES ± 0.2						CHK'D: GJEEVANSURES 2019/04/10				
1 PLACE ±						APPR: ISHWARG 2019/04/15				
0 PLACES ±						INITIAL REVISION:				
ANGULAR TOL ± 3.0°						DRWN: SKLIM01 2006/03/23				
DRAFT WHERE APPLICABLE MUST REMAIN WITHIN DIMENSIONS						APPR: PATEY 2006/03/29				
THIRD ANGLE PROJECTION		DRAWING		SERIES		MATERIAL NUMBER		CUSTOMER		
		A3-SIZE		87759		SEE TABLE		GENERAL MARKET		

DOCUMENT STATUS | P1 | RELEASE DATE | 2019/04/15 06:29:54

10	9	8	7	6	5	4	3	2	1									
PART NUMBER WITHOUT CAP IN TUBE	PART NUMBER WITH CAP IN TUBE	PART NUMBER WITH CAP IN TAPE & REEL	CKT SIZE	PEG	PLATING TYPE	VOID POSITION	A	B	C	M	(F)	(G)	Bo	F1	So	W	EMBOSSED TYPE	
F	87759-6203	87759-7203	87759-8203	20	Y	3	----	19.90	18.00	---	3.20	5.90	8.10	20.50	20.20	40.40	44.00	B
	----	87759-8053	87759-8054	20	N	2	----	19.90	18.00	----	3.80	6.50	8.70	20.20	14.20	28.40	32.00	B
	----	87759-0019	87759-0020	20	Y	1	----	19.90	18.00	16.00	3.20	5.90	8.05	20.50	20.20	40.40	44.00	B
	87759-5801	87759-5802	87759-2058	20	Y	1	----	19.90	18.00	16.00	4.30	7.00	8.31	20.50	14.20	28.40	32.00	B
E	87759-2261	87759-2271	87759-2281	22	N	1	----	21.90	20.00	---	3.20	5.90	8.10	22.50	20.20	40.40	44.00	B
	87759-2262	87759-2272	87759-2282	22	N	2	----	21.90	20.00	---	3.20	5.90	8.10	22.50	20.20	40.40	44.00	B
	87759-2263	87759-2273	87759-2283	22	N	3	----	21.90	20.00	---	3.20	5.90	8.10	22.50	20.20	40.40	44.00	B
	87759-6221	87759-7221	87759-8221	22	Y	1	----	21.90	20.00	---	3.20	5.90	8.10	22.50	20.20	40.40	44.00	B
	87759-6222	87759-7222	87759-8222	22	Y	2	----	21.90	20.00	---	3.20	5.90	8.10	22.50	20.20	40.40	44.00	B
	87759-6223	87759-7223	87759-8223	22	Y	3	----	21.90	20.00	---	3.20	5.90	8.10	22.50	20.20	40.40	44.00	B
D																		
	87759-2461	87759-2471	87759-2481	24	N	1	----	23.90	22.00	---	3.20	5.90	8.10	24.50	20.20	40.40	44.00	B
	87759-2462	87759-2472	87759-2482	24	N	2	----	23.90	22.00	---	3.20	5.90	8.10	24.50	20.20	40.40	44.00	B
	87759-2463	87759-2473	87759-2483	24	N	3	----	23.90	22.00	---	3.20	5.90	8.10	24.50	20.20	40.40	44.00	B
	87759-6241	87759-7241	87759-8241	24	Y	1	----	23.90	22.00	---	3.20	5.90	8.10	24.50	20.20	40.40	44.00	B
	87759-6242	87759-7242	87759-8242	24	Y	2	----	23.90	22.00	---	3.20	5.90	8.10	24.50	20.20	40.40	44.00	B
C	87759-6243	87759-7243	87759-8243	24	Y	3	----	23.90	22.00	---	3.20	5.90	8.10	24.50	20.20	40.40	44.00	B
	87759-2661	87759-2671	87759-2681	26	N	1	----	25.90	24.00	---	3.20	5.90	8.10	26.50	20.20	40.40	44.00	B
	87759-2662	87759-2672	87759-2682	26	N	2	----	25.90	24.00	---	3.20	5.90	8.10	26.50	20.20	40.40	44.00	B
	87759-2663	87759-2673	87759-2683	26	N	3	----	25.90	24.00	---	3.20	5.90	8.10	26.50	20.20	40.40	44.00	B
	87759-6261	87759-7261	87759-8261	26	Y	1	----	25.90	24.00	---	3.20	5.90	8.10	26.50	20.20	40.40	44.00	B
	87759-6262	87759-7262	87759-8262	26	Y	2	----	25.90	24.00	---	3.20	5.90	8.10	26.50	20.20	40.40	44.00	B
	87759-6263	87759-7263	87759-8263	26	Y	3	----	25.90	24.00	---	3.20	5.90	8.10	26.50	20.20	40.40	44.00	B

THIS DRAWING CONTAINS INFORMATION THAT IS PROPRIETARY TO MOLEX ELECTRONIC TECHNOLOGIES, LLC AND SHOULD NOT BE USED WITHOUT WRITTEN PERMISSION

SYMBOLS		SCALE		CURRENT REV DESC: REMASTERED IN NX		
▽ = 0	mm	NTS		molex CUSTOM HEADER 2.00MM PITCH DUAL ROW HDR, SINGLE WAFER, SMT PRODUCT CUSTOMER DRAWING		
▽ = 0	GENERAL TOLERANCES (UNLESS SPECIFIED)		EC NO: 614469			
▽ = 0	4 PLACES ±	MM	INCH			DRWN: GJEEVANSURES 2019/02/12
▽ = 0	3 PLACES ±					CHK'D: GJEEVANSURES 2019/04/10
▽ = 0	2 PLACES ± 0.2					APPR: ISHWARG 2019/04/15
▽ = 0	1 PLACE ±			INITIAL REVISION:		
▽ = 0	0 PLACES ±			DRWN: SKLIM01 2006/03/23		
▽ = 0	ANGULAR TOL ± 3.0°			APPR: PATEY 2006/03/29		
■ = 0	DRAFT WHERE APPLICABLE MUST REMAIN WITHIN DIMENSIONS		THIRD ANGLE PROJECTION	DRAWING	SERIES	
▽ = 0				A3-SIZE	87759	

DOCUMENT NUMBER	DOC TYPE	DOC PART	REVISION
SD-87759-277	PSD	001	B3
MATERIAL NUMBER	CUSTOMER	SHEET NUMBER	
SEE TABLE	GENERAL MARKET	8 OF 12	

10	9	8	7	6	5	4	3	2	1									
PART NUMBER WITHOUT CAP IN TUBE	PART NUMBER WITH CAP IN TUBE	PART NUMBER WITH CAP IN TAPE & REEL	CKT SIZE	PEG	PLATING TYPE	VOID POSITION	A	B	C	M	(F)	(G)	Bo	F1	So	W	EMBOSSED TYPE	
F	87759-2861	87759-2871	87759-2881	28	N	1	----	27.90	26.00	---	3.20	5.90	8.10	28.50	20.20	40.40	44.00	B
	87759-2862	87759-2872	87759-2882	28	N	2	----	27.90	26.00	---	3.20	5.90	8.10	28.50	20.20	40.40	44.00	B
	87759-2863	87759-2873	87759-2883	28	N	3	----	27.90	26.00	---	3.20	5.90	8.10	28.50	20.20	40.40	44.00	B
	87759-6281	87759-7281	87759-8281	28	Y	1	----	27.90	26.00	---	3.20	5.90	8.10	28.50	20.20	40.40	44.00	B
	87759-6282	87759-7282	87759-8282	28	Y	2	----	27.90	26.00	---	3.20	5.90	8.10	28.50	20.20	40.40	44.00	B
E	87759-6283	87759-7283	87759-8283	28	Y	3	----	27.90	26.00	---	3.20	5.90	8.10	28.50	20.20	40.40	44.00	B
	87759-3061	87759-3071	87759-3081	30	N	1	----	29.90	28.00	---	3.20	5.90	8.10	30.50	20.20	40.40	44.00	B
	87759-3062	87759-3072	87759-3082	30	N	2	----	29.90	28.00	---	3.20	5.90	8.10	30.50	20.20	40.40	44.00	B
	87759-3063	87759-3073	87759-3083	30	N	3	----	29.90	28.00	---	3.20	5.90	8.10	30.50	20.20	40.40	44.00	B
	87759-6301	87759-7301	87759-8301	30	Y	1	----	29.90	28.00	---	3.20	5.90	8.10	30.50	20.20	40.40	44.00	B
D	87759-6302	87759-7302	87759-8302	30	Y	2	----	29.90	28.00	---	3.20	5.90	8.10	30.50	20.20	40.40	44.00	B
	87759-6303	87759-7303	87759-8303	30	Y	3	----	29.90	28.00	---	3.20	5.90	8.10	30.50	20.20	40.40	44.00	B
	87759-3261	87759-3271	87759-3281	32	N	1	----	31.90	30.00	---	3.20	5.90	8.10	32.50	26.20	52.40	56.00	B
	87759-3262	87759-3272	87759-3282	32	N	2	----	31.90	30.00	---	3.20	5.90	8.10	32.50	26.20	52.40	56.00	B
	87759-3263	87759-3273	87759-3283	32	N	3	----	31.90	30.00	---	3.20	5.90	8.10	32.50	26.20	52.40	56.00	B
C	87759-6321	87759-7321	87759-8321	32	Y	1	----	31.90	30.00	---	3.20	5.90	8.10	32.50	26.20	52.40	56.00	B
	87759-6322	87759-7322	87759-8322	32	Y	2	----	31.90	30.00	---	3.20	5.90	8.10	32.50	26.20	52.40	56.00	B
	87759-6323	87759-7323	87759-8323	32	Y	3	----	31.90	30.00	---	3.20	5.90	8.10	32.50	26.20	52.40	56.00	B
	87759-0009	-----	-----	32	Y	1	----	31.90	30.00	28.00	8.00	10.70	---	----	----	----	----	---
	87759-0010	-----	-----	32	N	1	----	31.90	30.00	28.00	8.00	10.70	---	----	----	----	----	---

B										A																																																		
<p>SYMBOLS</p> <p>▽ = 0</p> <p>▽ = 0</p> <p>▽ = 0</p> <p>▽ = 0</p> <p>▽ = 0</p> <p>▽ = 0</p> <p>▽ = 0</p> <p>▽ = 0</p> <p>▽ = 0</p> <p>▽ = 0</p> <p>▽ = 0</p> <p>▽ = 0</p>										<p>THIS DRAWING CONTAINS INFORMATION THAT IS PROPRIETARY TO MOLEX ELECTRONIC TECHNOLOGIES, LLC AND SHOULD NOT BE USED WITHOUT WRITTEN PERMISSION</p> <p>CURRENT REV DESC: REMASTERED IN NX</p> <p>EC NO: 614469</p> <p>DRWN: GJEEVANSURES 2019/02/12</p> <p>CHK'D: GJEEVANSURES 2019/04/10</p> <p>APPR: ISHWARG 2019/04/15</p> <p>INITIAL REVISION:</p> <p>DRWN: SKLIM01 2006/03/23</p> <p>APPR: PATEY 2006/03/29</p> <p>THIRD ANGLE PROJECTION</p> <p>DRAFT WHERE APPLICABLE MUST REMAIN WITHIN DIMENSIONS</p>										<p>SCALE</p> <p>mm NTS</p> <p>GENERAL TOLERANCES (UNLESS SPECIFIED)</p> <table border="1"> <tr> <th></th> <th>MM</th> <th>INCH</th> </tr> <tr> <td>4 PLACES</td> <td>±</td> <td>±</td> </tr> <tr> <td>3 PLACES</td> <td>±</td> <td>±</td> </tr> <tr> <td>2 PLACES</td> <td>± 0.2</td> <td>±</td> </tr> <tr> <td>1 PLACE</td> <td>±</td> <td>±</td> </tr> <tr> <td>0 PLACES</td> <td>±</td> <td>±</td> </tr> <tr> <td>ANGULAR TOL</td> <td colspan="2">± 3.0°</td> </tr> </table>											MM	INCH	4 PLACES	±	±	3 PLACES	±	±	2 PLACES	± 0.2	±	1 PLACE	±	±	0 PLACES	±	±	ANGULAR TOL	± 3.0°		<p>molex</p> <p>CUSTOM HEADER</p> <p>2.00MM PITCH DUAL ROW HDR, SINGLE WAFER, SMT</p> <p>PRODUCT CUSTOMER DRAWING</p> <p>DOCUMENT NUMBER: SD-87759-277</p> <p>DOC TYPE: PSD</p> <p>DOC PART: 001</p> <p>REVISION: B3</p> <p>MATERIAL NUMBER: SEE TABLE</p> <p>CUSTOMER: GENERAL MARKET</p> <p>SHEET NUMBER: 9 OF 12</p>									
	MM	INCH																																																										
4 PLACES	±	±																																																										
3 PLACES	±	±																																																										
2 PLACES	± 0.2	±																																																										
1 PLACE	±	±																																																										
0 PLACES	±	±																																																										
ANGULAR TOL	± 3.0°																																																											
<p>DOCUMENT STATUS: P1</p> <p>RELEASE DATE: 2019/04/15 06:29:54</p>																																																												

10	9	8	7	6	5	4	3	2	1									
PART NUMBER WITHOUT CAP IN TUBE	PART NUMBER WITH CAP IN TUBE	PART NUMBER WITH CAP IN TAPE & REEL	CKT SIZE	PEG	PLATING TYPE	VOID POSITION	A	B	C	M	(F)	(G)	Bo	F1	So	W	EMBOSSED TYPE	
F	87759-3461	87759-3471	87759-3481	34	N	1	----	33.90	32.00	---	3.20	5.90	8.10	34.50	26.20	52.40	56.00	B
	87759-3462	87759-3472	87759-3482	34	N	2	----	33.90	32.00	---	3.20	5.90	8.10	34.50	26.20	52.40	56.00	B
	87759-3463	87759-3473	87759-3483	34	N	3	----	33.90	32.00	---	3.20	5.90	8.10	34.50	26.20	52.40	56.00	B
	87759-6341	87759-7341	87759-8341	34	Y	1	----	33.90	32.00	---	3.20	5.90	8.10	34.50	26.20	52.40	56.00	B
	87759-6342	87759-7342	87759-8342	34	Y	2	----	33.90	32.00	---	3.20	5.90	8.10	34.50	26.20	52.40	56.00	B
E	87759-6343	87759-7343	87759-8343	34	Y	3	----	33.90	32.00	---	3.20	5.90	8.10	34.50	26.20	52.40	56.00	B
	87759-3661	87759-3671	87759-3681	36	N	1	----	35.90	34.00	---	3.20	5.90	8.10	36.50	26.20	52.40	56.00	B
	87759-3662	87759-3672	87759-3682	36	N	2	----	35.90	34.00	---	3.20	5.90	8.10	36.50	26.20	52.40	56.00	B
	87759-3663	87759-3673	87759-3683	36	N	3	----	35.90	34.00	---	3.20	5.90	8.10	36.50	26.20	52.40	56.00	B
	87759-6361	87759-7361	87759-8361	36	Y	1	----	35.90	34.00	---	3.20	5.90	8.10	36.50	26.20	52.40	56.00	B
D	87759-6362	87759-7362	87759-8362	36	Y	2	----	35.90	34.00	---	3.20	5.90	8.10	36.50	26.20	52.40	56.00	B
	87759-6363	87759-7363	87759-8363	36	Y	3	----	35.90	34.00	---	3.20	5.90	8.10	36.50	26.20	52.40	56.00	B
	87759-0014	----	----	36	N	1	----	35.90	34.00	---	9.50	12.20	---	---	---	---	---	---
	87759-3861	87759-3871	87759-3881	38	N	1	----	37.90	36.00	---	3.20	5.90	8.10	38.50	26.20	52.40	56.00	B
	87759-3862	87759-3872	87759-3882	38	N	2	----	37.90	36.00	---	3.20	5.90	8.10	38.50	26.20	52.40	56.00	B
C	87759-3863	87759-3873	87759-3883	38	N	3	----	37.90	36.00	---	3.20	5.90	8.10	38.50	26.20	52.40	56.00	B
	87759-6381	87759-7381	87759-8381	38	Y	1	----	37.90	36.00	---	3.20	5.90	8.10	38.50	26.20	52.40	56.00	B
	87759-6382	87759-7382	87759-8382	38	Y	2	----	37.90	36.00	---	3.20	5.90	8.10	38.50	26.20	52.40	56.00	B
	87759-6383	87759-7383	87759-8383	38	Y	3	----	37.90	36.00	---	3.20	5.90	8.10	38.50	26.20	52.40	56.00	B

<p>THIS DRAWING CONTAINS INFORMATION THAT IS PROPRIETARY TO MOLEX ELECTRONIC TECHNOLOGIES, LLC AND SHOULD NOT BE USED WITHOUT WRITTEN PERMISSION</p> <p>CURRENT REV DESC: REMASTERED IN NX</p>										<p>molex</p> <p>CUSTOM HEADER</p> <p>2.00MM PITCH DUAL ROW HDR, SINGLE WAFER, SMT</p> <p>PRODUCT CUSTOMER DRAWING</p>																											
<p>SYMBOLS</p> <p>▽ = 0</p> <p>▽ = 0</p> <p>▽ = 0</p> <p>▽ = 0</p> <p>▽ = 0</p> <p>▽ = 0</p> <p>▽ = 0</p> <p>▽ = 0</p> <p>▽ = 0</p> <p>▽ = 0</p>		<p>DIMENSION UNITS</p> <p>mm</p>		<p>SCALE</p> <p>NTS</p>		<p>GENERAL TOLERANCES (UNLESS SPECIFIED)</p> <table border="1"> <tr><th></th><th>MM</th><th>INCH</th></tr> <tr><td>4 PLACES</td><td>±</td><td>±</td></tr> <tr><td>3 PLACES</td><td>±</td><td>±</td></tr> <tr><td>2 PLACES</td><td>± 0.2</td><td>±</td></tr> <tr><td>1 PLACE</td><td>±</td><td>±</td></tr> <tr><td>0 PLACES</td><td>±</td><td>±</td></tr> </table>			MM	INCH	4 PLACES	±	±	3 PLACES	±	±	2 PLACES	± 0.2	±	1 PLACE	±	±	0 PLACES	±	±	<p>EC NO: 614469</p> <p>DRWN: GJEEVANSURES 2019/02/12</p> <p>CHK'D: GJEEVANSURES 2019/04/10</p> <p>APPR: ISHWARG 2019/04/15</p>		<p>INITIAL REVISION:</p> <p>DRWN: SKLIM01 2006/03/23</p> <p>APPR: PATEY 2006/03/29</p>		<p>DOCUMENT NUMBER</p> <p>SD-87759-277</p>		<p>DOC TYPE</p> <p>PSD</p>		<p>DOC PART</p> <p>001</p>		<p>REVISION</p> <p>B3</p>	
	MM	INCH																																			
4 PLACES	±	±																																			
3 PLACES	±	±																																			
2 PLACES	± 0.2	±																																			
1 PLACE	±	±																																			
0 PLACES	±	±																																			
<p>DOCUMENT STATUS</p> <p>P1</p>		<p>RELEASE DATE</p> <p>2019/04/15 06:29:54</p>		<p>DRAFT WHERE APPLICABLE MUST REMAIN WITHIN DIMENSIONS</p>		<p>THIRD ANGLE PROJECTION</p>		<p>DRAWING</p> <p>A3-SIZE</p>		<p>SERIES</p> <p>87759</p>		<p>MATERIAL NUMBER</p> <p>SEE TABLE</p>		<p>CUSTOMER</p> <p>GENERAL MARKET</p>		<p>SHEET NUMBER</p> <p>10 OF 12</p>																					

10	9	8	7	6	5	4	3	2
PART NUMBER WITHOUT CAP IN TUBE	PART NUMBER WITH CAP IN TUBE	PART NUMBER WITH CAP IN TAPE & REEL	PART NUMBER WITHOUT CAP IN TAPE & REEL	CKT SIZE	PEG	PLATING TYPE	VOID POSITION	EMBOSSED TYPE
F 87759-4061	87759-4071	87759-4081	-----	40	N	1	----	B
87759-4062	87759-4072	87759-4082	-----	40	N	2	----	B
87759-4063	87759-4073	87759-4083	-----	40	N	3	----	B
87759-6401	87759-7401	87759-8401	-----	40	Y	1	----	B
87759-6402	87759-7402	87759-8402	-----	40	Y	2	----	B
87759-6403	87759-7403	87759-8403	-----	40	Y	3	----	B
E 87759-0010	----	-----	-----	40	N	1	----	---
87759-0011	-----	-----	-----	40	Y	1	----	---
-----	-----	-----	-----	40	N	4	----	B
87759-4014	-----	-----	87759-0484	40	N	1	----	B
87759-4015	-----	-----	87759-4065	40	N	2	----	B
D 87759-4261	87759-4271	87759-4281	-----	42	N	1	----	B
87759-4262	87759-4272	87759-4282	-----	42	N	2	----	B
87759-4263	87759-4273	87759-4283	-----	42	N	3	----	B
87759-6421	87759-7421	87759-8421	-----	42	Y	1	----	B
87759-6422	87759-7422	87759-8422	-----	42	Y	2	----	B
C 87759-6423	87759-7423	87759-8423	-----	42	Y	3	----	B
87759-4461	87759-4471	87759-4481	-----	44	N	1	----	B
87759-4462	87759-4472	87759-4482	-----	44	N	2	----	B
87759-4463	87759-4473	87759-4483	-----	44	N	3	----	B
87759-6441	87759-7441	87759-8441	-----	44	Y	1	----	B
87759-6442	87759-7442	87759-8442	-----	44	Y	2	----	B
87759-6443	87759-7443	87759-8443	-----	44	Y	3	----	B

SYMBOLS	THIS DRAWING CONTAINS INFORMATION THAT IS PROPRIETARY TO MOLEX ELECTRONIC TECHNOLOGIES, LLC AND SHOULD NOT BE USED WITHOUT WRITTEN PERMISSION	
	mm	NTS
	GENERAL TOLERANCES (UNLESS SPECIFIED)	
	4 PLACES ±	±
3 PLACES ±	±	
2 PLACES ±	0.2 ±	
1 PLACE ±	±	
0 PLACES ±	±	
ANGULAR TOL ±	3.0°	
DRAFT WHERE APPLICABLE MUST REMAIN WITHIN DIMENSIONS	THIRD ANGLE PROJECTION	DRAWING
		A3-SIZE

CURRENT REV DESC: REMASTERED IN NX		
EC NO: 614469	DRWN: GJEEVANSURES	2019/02/12
CHK'D: GJEEVANSURES	2019/04/10	
APPR: ISHWARG	2019/04/15	
INITIAL REVISION:		
DRWN: SKLIM01	2006/03/23	
APPR: PATEY	2006/03/29	

molex		
CUSTOM HEADER		
2.00MM PITCH DUAL ROW HDR, SINGLE WAFER, SMT		
PRODUCT CUSTOMER DRAWING		
DOCUMENT NUMBER	DOC TYPE	DOC PART
SD-87759-277	PSD	001
REVISION	B3	
MATERIAL NUMBER	CUSTOMER	SHEET NUMBER
SEE TABLE	GENERAL MARKET	11 OF 12

10	9	8	7	6	5	4	3	2	1									
PART NUMBER WITHOUT CAP IN TUBE	PART NUMBER WITH CAP IN TUBE	PART NUMBER WITH CAP IN TAPE & REEL	CKT SIZE	PEG	PLATING TYPE	VOID POSITION	A	B	C	M	(F)	(G)	Bo	F1	So	W	EMBOSSSED TYPE	
F	87759-4661	87759-4671	87759-4681	46	N	1	----	45.90	44.00	---	3.20	5.90	8.10	46.50	34.20	68.40	72.00	B
	87759-4662	87759-4672	87759-4682	46	N	2	----	45.90	44.00	---	3.20	5.90	8.10	46.50	34.20	68.40	72.00	B
	87759-4663	87759-4673	87759-4683	46	N	3	----	45.90	44.00	---	3.20	5.90	8.10	46.50	34.20	68.40	72.00	B
	87759-6461	87759-7461	87759-8461	46	Y	1	----	45.90	44.00	---	3.20	5.90	8.10	46.50	34.20	68.40	72.00	B
	87759-6462	87759-7462	87759-8462	46	Y	2	----	45.90	44.00	---	3.20	5.90	8.10	46.50	34.20	68.40	72.00	B
E	87759-6463	87759-7463	87759-8463	46	Y	3	----	45.90	44.00	---	3.20	5.90	8.10	46.50	34.20	68.40	72.00	B
	87759-4861	87759-4871	87759-4881	48	N	1	----	47.90	46.00	---	3.20	5.90	8.10	48.50	34.20	68.40	72.00	B
	87759-4862	87759-4872	87759-4882	48	N	2	----	47.90	46.00	---	3.20	5.90	8.10	48.50	34.20	68.40	72.00	B
	87759-4863	87759-4873	87759-4883	48	N	3	----	47.90	46.00	---	3.20	5.90	8.10	48.50	34.20	68.40	72.00	B
	87759-6481	87759-7481	87759-8481	48	Y	1	----	47.90	46.00	---	3.20	5.90	8.10	48.50	34.20	68.40	72.00	B
D	87759-6482	87759-7482	87759-8482	48	Y	2	----	47.90	46.00	---	3.20	5.90	8.10	48.50	34.20	68.40	72.00	B
	87759-6483	87759-7483	87759-8483	48	Y	3	----	47.90	46.00	---	3.20	5.90	8.10	48.50	34.20	68.40	72.00	B
	87759-5061	87759-5071	87759-5081	50	N	1	----	49.90	48.00	---	3.20	5.90	8.10	50.50	34.20	68.40	72.00	B
	87759-5062	87759-5072	87759-5082	50	N	2	----	49.90	48.00	---	3.20	5.90	8.10	50.50	34.20	68.40	72.00	B
	87759-5063	87759-5073	87759-5083	50	N	3	----	49.90	48.00	---	3.20	5.90	8.10	50.50	34.20	68.40	72.00	B
C	87759-6501	87759-7501	87759-8501	50	Y	1	----	49.90	48.00	---	3.20	5.90	8.10	50.50	34.20	68.40	72.00	B
	87759-6502	87759-7502	87759-8502	50	Y	2	----	49.90	48.00	---	3.20	5.90	8.10	50.50	34.20	68.40	72.00	B
	87759-6503	87759-7503	87759-8503	50	Y	3	----	49.90	48.00	---	3.20	5.90	8.10	50.50	34.20	68.40	72.00	B

B										B									
A										A									

SYMBOLS										THIS DRAWING CONTAINS INFORMATION THAT IS PROPRIETARY TO MOLEX ELECTRONIC TECHNOLOGIES, LLC AND SHOULD NOT BE USED WITHOUT WRITTEN PERMISSION									
DIMENSION UNITS					SCALE					CURRENT REV DESC: REMASTERED IN NX									
mm					NTS					<p>molex</p> <p>CUSTOM HEADER</p> <p>2.00MM PITCH DUAL ROW HDR, SINGLE WAFER, SMT</p> <p>PRODUCT CUSTOMER DRAWING</p>									
GENERAL TOLERANCES (UNLESS SPECIFIED)																			
4 PLACES ±					MM					INCH					EC NO: 614469				
3 PLACES ±															DRWN: GJEEVANSURES 2019/02/12				
2 PLACES ± 0.2															CHK'D: GJEEVANSURES 2019/04/10				
1 PLACE ±															APPR: ISHWARG 2019/04/15				
0 PLACES ±															INITIAL REVISION:				
ANGULAR TOL ± 3.0°															DRWN: SKLIM01 2006/03/23				
DRAFT WHERE APPLICABLE MUST REMAIN WITHIN DIMENSIONS					THIRD ANGLE PROJECTION					DRAWING					SERIES				
					A3-SIZE					87759					MATERIAL NUMBER				
															CUSTOMER				
															SEE TABLE				
															GENERAL MARKET				
															SHEET NUMBER				
															12 OF 12				