

## DUAL OPERATIONAL AMPLIFIER

### ■ GENERAL DESCRIPTION

The NJM14558 is a dual operational amplifier, which can operate from  $\pm 2V$  supply. The features are low offset voltage, low bias current and low current consumption.

The package lineup is DIP, DMP and others, so that the NJM14558 is suitable for portable audio and any kind of signal amplifier.

### ■ FEATURES

- Operating Voltage  $\pm 2.0V \sim \pm 7.0V$
- Input Offset Voltage 3mV max.
- Slew Rate 2.5V/ $\mu s$  typ.
- Bipolar Technology
- Package Outline DIP8, DMP8, SOP8 JEDEC 150mil  
SSOP8, SIP8,  
MSOP8 (VSP8) MEET JEDEC MO-187-DA

### ■ PACKAGE OUTLINE

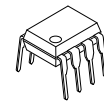

NJM14558D  
(DIP8)

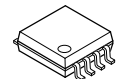

NJM14558M  
(DMP8)

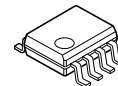

NJM14558E  
(SOP8)



NJM14558V  
(SSOP8)



NJM14558R  
(MSOP8(VSP8))

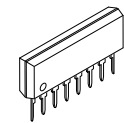

NJM14558L  
(SIP8)

### ■ PIN CONFIGURATION

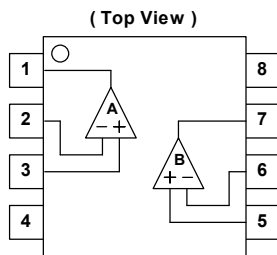

NJM14558D/14558M/14558E  
NJM14558V/14558R

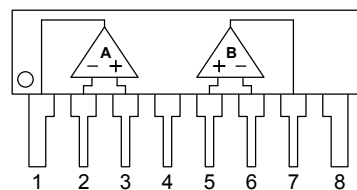

NJM14558L

### PIN FUNCTION

1. A OUTPUT
2. A -INPUT
3. A +INPUT
4. V<sup>-</sup>
5. B +INPUT
6. B -INPUT
7. B OUTPUT
8. V<sup>+</sup>

### ■ EQUIVALENT CIRCUIT (1/2 Shown)

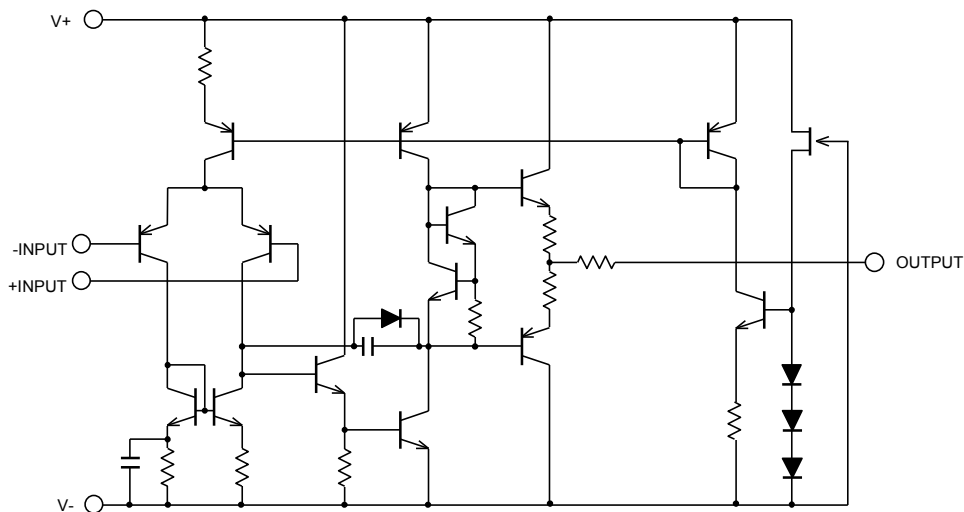

# NJM14558

## ■ ABSOLUTE MAXIMUM RATINGS (Ta=25°C)

PARAMETER	SYMBOL	RATINGS	UNIT
Supply Voltage	$V^+ / V^-$	$\pm 7.5$	V
Differential Input Voltage	$V_{ID}$	$\pm 14$	V
Input Voltage	$V_{IC}$	$\pm 7$ ( note )	V
Power Dissipation	$P_D$	( DIP8 ) 500 ( DMP8 ) 300 ( SOP8 ) 300 ( SSOP8 ) 250 ( MSOP8(VSP8) ) 320 ( SIP8 ) 800	mW
Operating Temperature Range	$T_{opr}$	-40~+85	°C
Storage Temperature Range	$T_{stg}$	-40~+125	°C

( note ) For supply voltage less than  $\pm 7V$ , the absolute maximum input voltage is equal to the supply voltage.

## ■ ELECTRICAL CHARACTERISTICS ( $V^+ / V^- = \pm 5V, Ta=25^\circ C$ )

PARAMETER	SYMBOL	TEST CONDITION	MIN.	TYP.	MAX.	UNIT
Operating Voltage	$V_{opr}$		$\pm 2$	-	$\pm 7$	V
Input Offset Voltage	$V_{IO}$	$R_S \leq 10k\Omega$	-	0.5	3	mV
Input Offset Current	$I_{IO}$		-	5	50	nA
Input Bias Current	$I_B$		-	70	250	nA
Input Resistance	$R_{IN}$		0.3	5	-	MΩ
Large Signal Voltage Gain	$A_V$	$R_L \geq 2k\Omega, V_O = \pm 3V$	86	100	-	dB
Maximum Output Voltage Swing ( + )	$V_{OM}^+$	$R_L \geq 2k\Omega$	3.5	4.0	-	V
Maximum Output Voltage Swing ( - )	$V_{OM}^-$	$R_L \geq 2k\Omega$	-	-3.5	-3.0	V
Input Common Mode Voltage Range	$V_{ICM}$		$\pm 3.0$	$\pm 4.0$	-	V
Common Mode Rejection Ratio	CMR	$R_S \leq 10k\Omega$	70	90	-	dB
Supply Voltage Rejection Ratio	SVR	$R_S \leq 10k\Omega$	76.5	90	-	dB
Operating Current	$I_{CC}$		-	2.7	4.5	mA
Slew Rate	SR		-	2.5	-	V/ $\mu s$
Equivalent Input Noise Voltage	$V_{NI}$	RIAA, $R_S = 2.2k\Omega, 30kHz$ :LPF	-	1.4	-	$\mu V_{rms}$
Gain Bandwidth Product	GB		-	5	-	MHz

## ■ TYPICAL CHARACTERISTICS

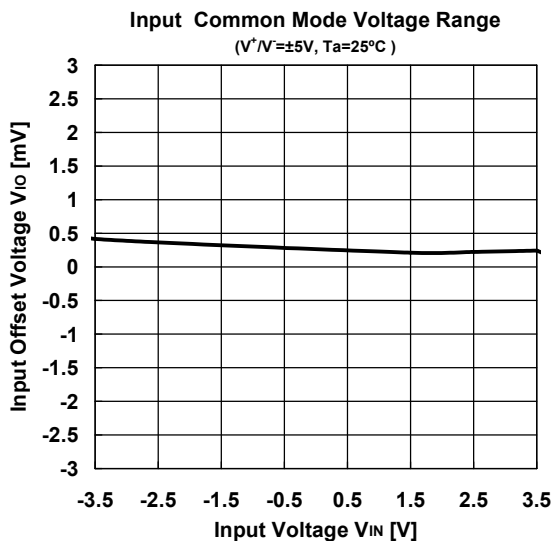
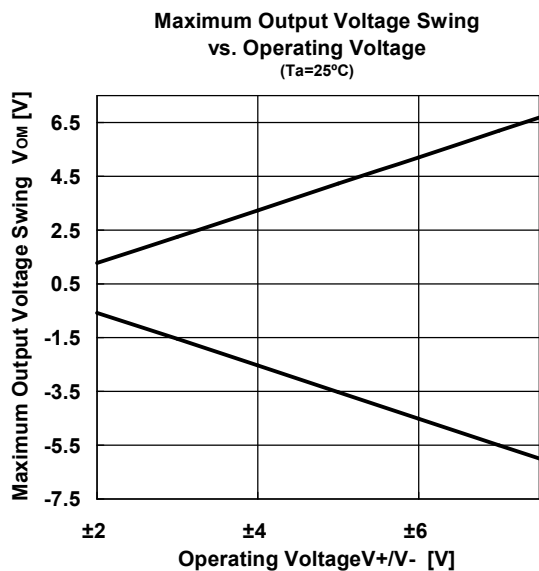
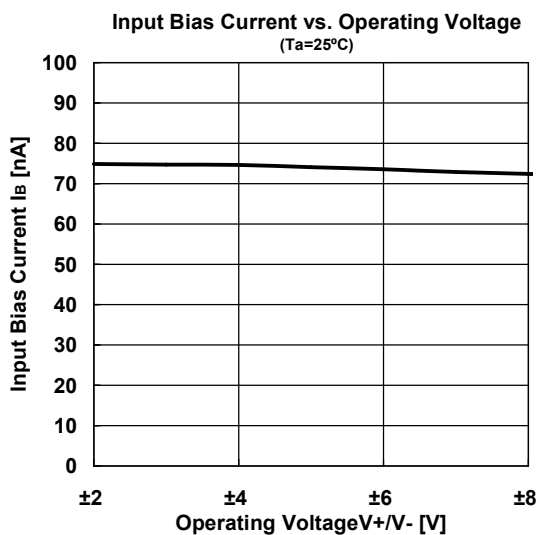
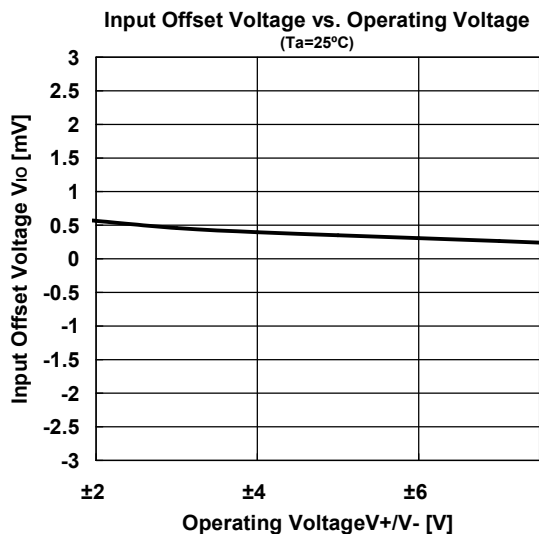
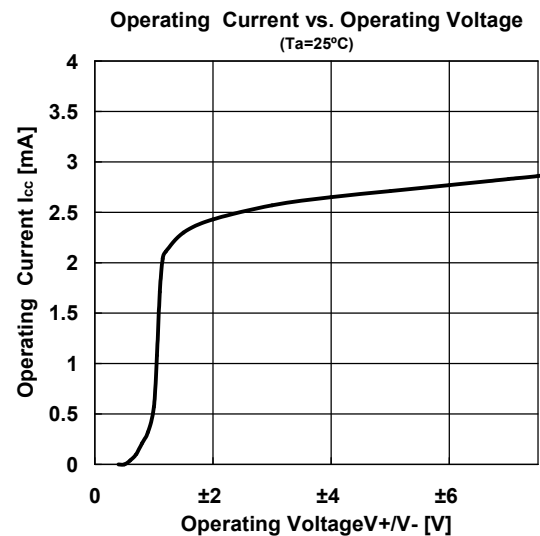

# NJM14558

## ■ TYPICAL CHARACTERISTICS

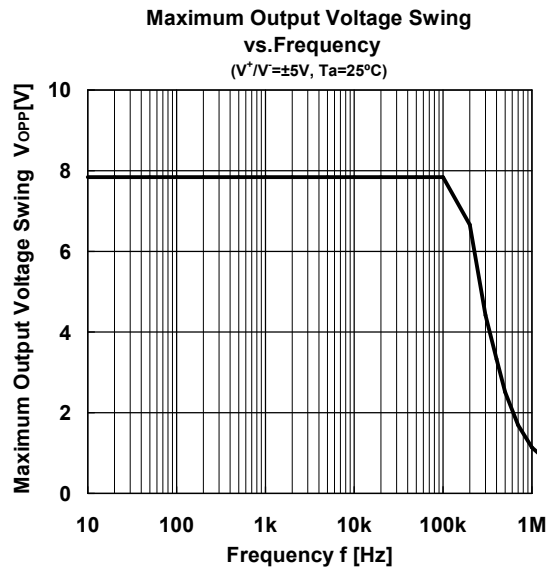
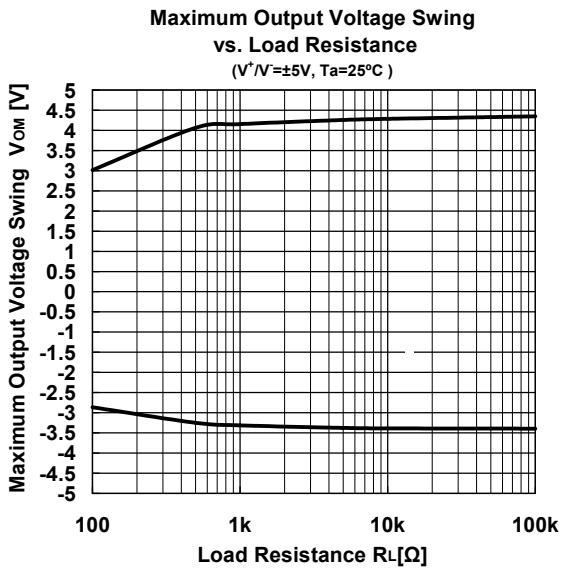

## ■ TYPICAL CHARACTERISTICS

Large signal Voltage Gain vs. Operating Voltage  
( $T_a=25^\circ\text{C}$ )

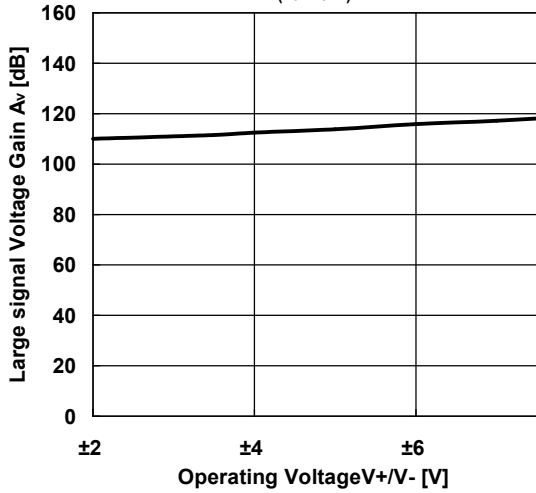

Large signal Voltage Gain vs. Frequency  
( $V^+/V^-=\pm 5\text{V}, T_a=25^\circ\text{C}$ )

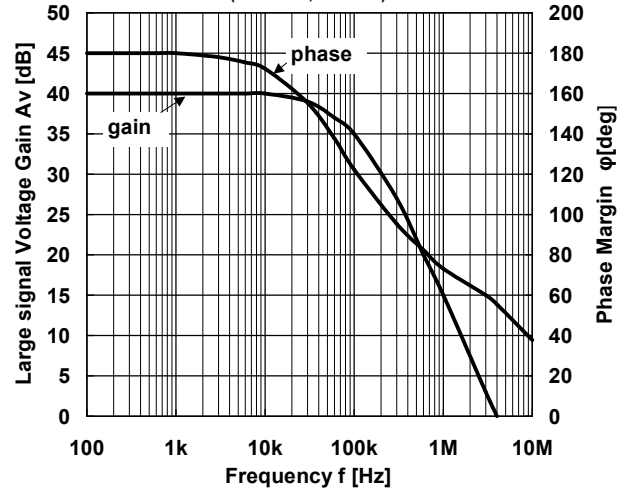

Slew Rate(Fall)

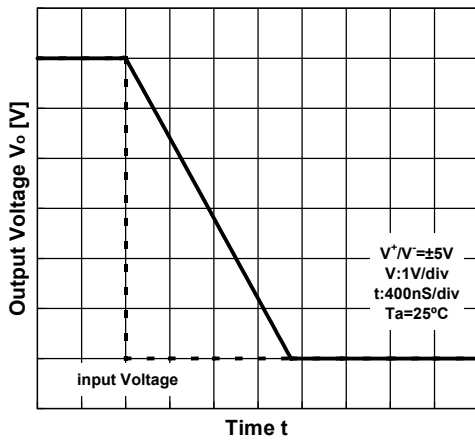

Slew Rate(Rise)

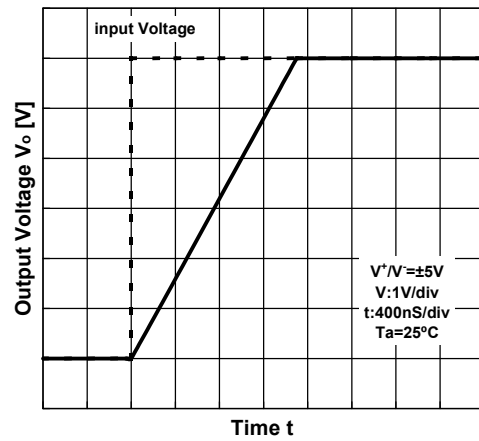

THD vs. Output Voltage  
( $V^{\pm}=\pm 5\text{V}, T_a=25^\circ\text{C}$ )

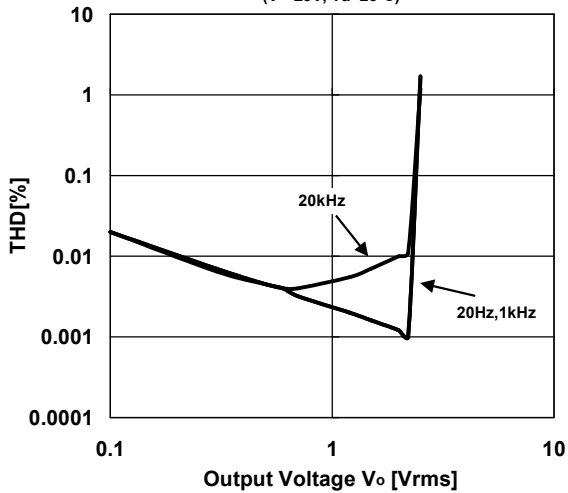

Equivalent Input Noise Voltage vs. Frequency  
( $V^+/V^-=\pm 5\text{V}, T_a=25^\circ\text{C}$ )

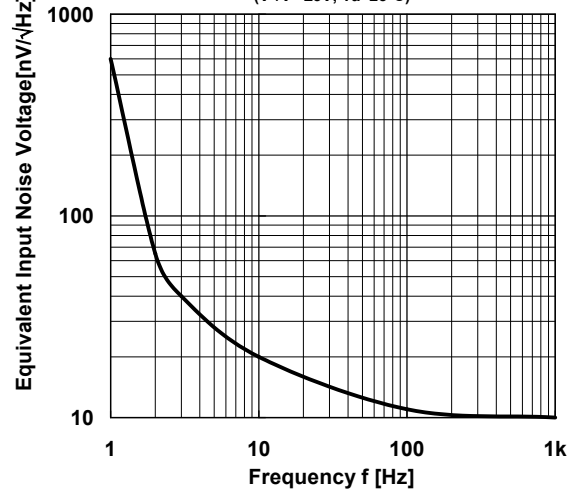

## ■ TYPICAL CHARACTERISTICS

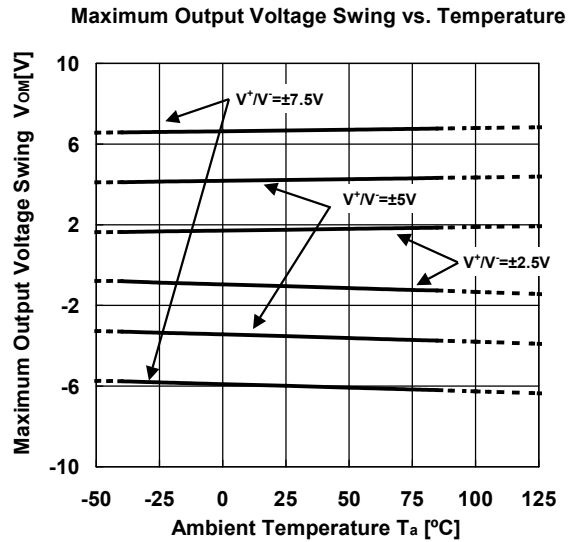
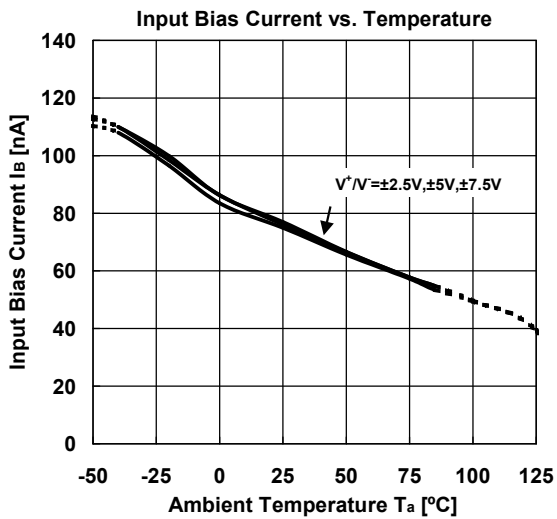
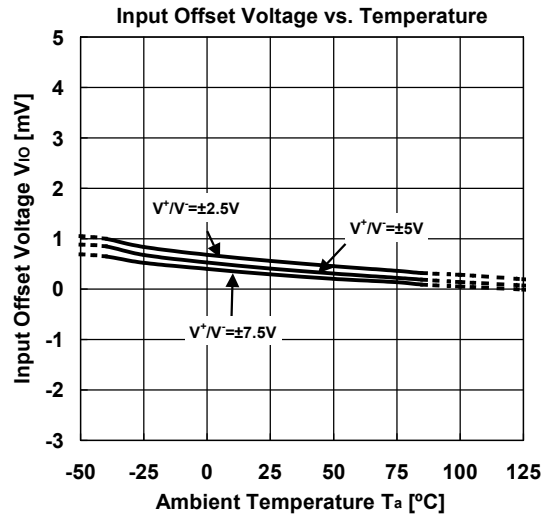
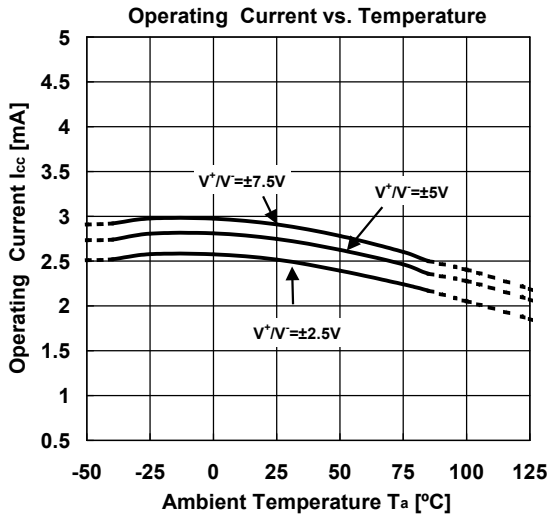

## ■ TYPICAL CHARACTERISTICS

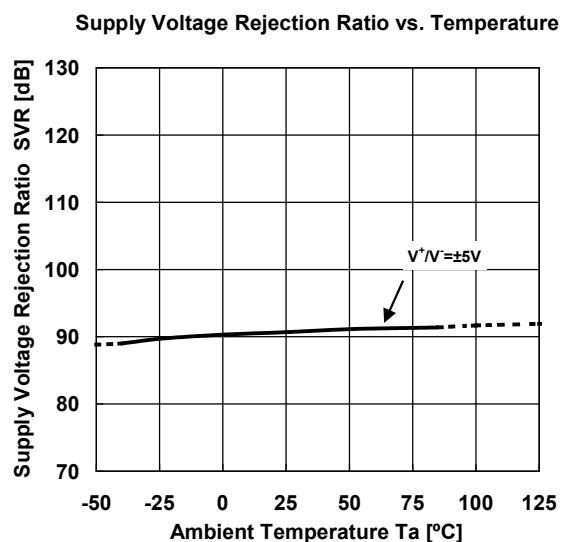
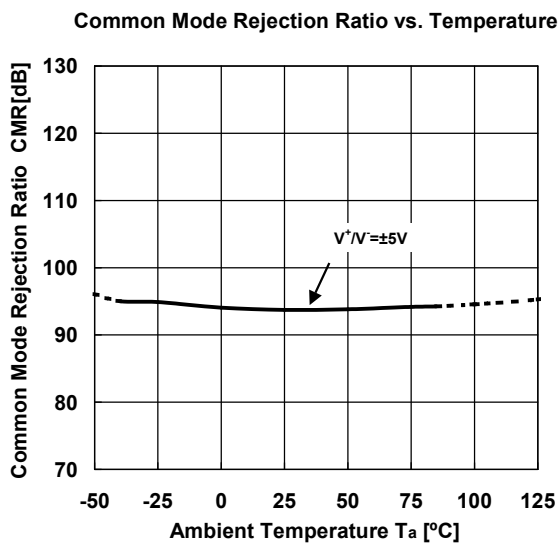
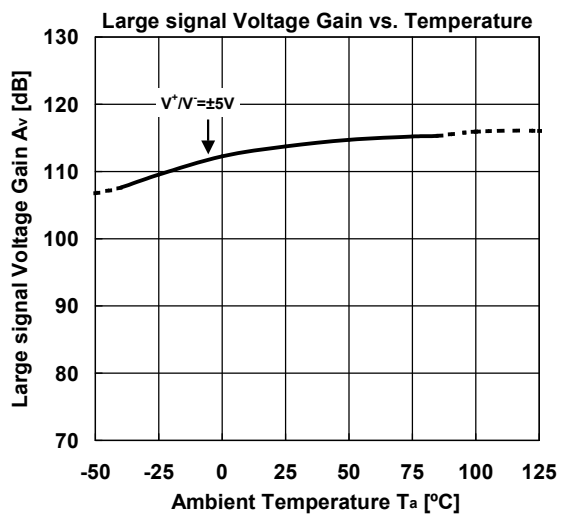

[CAUTION]  
 The specifications on this databook are only given for information, without any guarantee as regards either mistakes or omissions. The application circuits in this databook are described only to show representative usages of the product and not intended for the guarantee or permission of any right including the industrial rights.

# Mouser Electronics

Authorized Distributor

Click to View Pricing, Inventory, Delivery & Lifecycle Information:

[NJR:](#)

[NJM14558D](#) [NJM14558M](#) [NJM14558E](#) [NJM14558M-TE1](#) [NJM14558M-TE2](#) [NJM14558V-TE2](#) [NJM14558V-TE1](#)  
[NJM14558MD](#) [NJM14558MD-TE2](#)