

### 4 PIN SSOP PHOTOTRANSISTOR PHOTOCOUPLER EL3H7-G Series

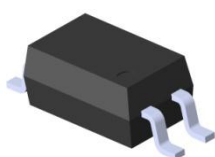

Schematic

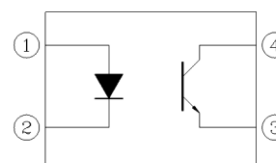

Pin Configuration

1. Anode
2. Cathode
3. Emitter
4. Collector

#### Features:

- Halogens free
- Current transfer ratio  
(CTR: 50~600% at  $I_F = 5\text{mA}$ ,  $V_{CE} = 5\text{V}$ )  
(CTR: 40~320% at  $I_F = 10\text{mA}$ ,  $V_{CE} = 5\text{V}$ )
- High isolation voltage between input and output ( $V_{iso} = 3750\text{ V rms}$ )
- Compact 4 Pin SSOP with a 2.0 mm profile
- Pb free and RoHS compliant.
- UL approved (No. E214129)
- VDE approved (No. 132249)
- SEMKO approved
- NEMKO approved
- DEMKO approved
- FIMKO approved
- CSA approved

#### Description

The EL3H7-G series devices consist of an infrared emitting diode, optically coupled to a phototransistor detector encapsulated with green compound.

They are packaged in a 4-pin small outline SMD package.

#### Applications

- DC-DC Converters
- Programmable controllers
- Telecommunication equipments
- Signal transmission between circuits of different potentials and impedances

**Absolute Maximum Ratings (Ta=25°C)**

	Parameter	Symbol	Rating	Unit
Input	Forward current	$I_F$	50	mA
	Peak forward current (1 us, pulse)	$I_{FP}$	1	A
	Reverse voltage	$V_R$	6	V
	Power dissipation Derating factor (above $T_a = 90^\circ\text{C}$ )	$P_D$	70 2.0	mW mW/°C
Output	Power dissipation Derating factor (above $T_a = 70^\circ\text{C}$ )	$P_C$	150 3.1	mW mW/°C
	Collector current	$I_C$	50	mA
	Collector-Emitter voltage	$V_{CEO}$	80	V
	Emitter-Collector voltage	$V_{ECO}$	7	V
	Total Power Dissipation	$P_{TOT}$	200	mW
Isolation Voltage*1	$V_{ISO}$	3750	Vrms	
Operating temperature	$T_{OPR}$	-55 ~ +110	°C	
Storage temperature	$T_{STG}$	-55 ~ +125	°C	
Soldering Temperature*2	$T_{SOL}$	260	°C	

Notes:

\*1 AC for 1 minute, R.H.= 40 ~ 60% R.H. In this test, pins 1, 2 are shorted together, and pins 3, 4 are shorted together.

\*2 For 10 seconds

**Electro-Optical Characteristics (Ta=25°C unless specified otherwise)**

**Input**

Parameter	Symbol	Min.	Typ.	Max.	Unit	Condition
Forward voltage	$V_F$	-	1.2	1.4	V	$I_F = 20\text{mA}$
Reverse current	$I_R$	-	-	10	$\mu\text{A}$	$V_R = 4\text{V}$
Input capacitance	$C_{in}$	-	30	250	pF	$V = 0, f = 1\text{kHz}$

**Output**

Parameter	Symbol	Min	Typ.	Max.	Unit	Condition
Collector-Emitter dark current	$I_{CEO}$	-	-	100	nA	$V_{CE} = 20\text{V}, I_F = 0\text{mA}$
Collector-Emitter breakdown voltage	$BV_{CEO}$	80	-	-	V	$I_C = 0.1\text{mA}$
Emitter-Collector breakdown voltage	$BV_{ECO}$	7	-	-	V	$I_E = 0.1\text{mA}$

**Transfer Characteristics (Ta=25°C unless specified otherwise)**

Parameter	Symbol	Min	Typ.	Max.	Unit	Condition	
Current Transfer ratio	EL3H7	50	-	600	%	$I_F = 5\text{mA}, V_{CE} = 5\text{V}$	
	EL3H7A	80	-	160			
	EL3H7B	130	-	260			
	EL3H7C	200	-	400			
	EL3H7D	300	-	600			
	EL3H7E	CTR	100	-			200
	EL3H7F		150	-			300
	EL3H7H		40	-			80
	EL3H7I		63	-			125
	EL3H7J		100	-			200
	EL3H7K		160	-			320
Collector-Emitter saturation voltage	$V_{CE(sat)}$	-	0.1	0.2	V	$I_F = 10\text{mA}, I_C = 1\text{mA}$	
Isolation resistance	$R_{IO}$	$5 \times 10^{10}$	-	-	$\Omega$	$V_{IO} = 500\text{Vdc}, 40\text{-}60\% \text{ R.H.}$	
Floating capacitance	$C_{IO}$	-	0.3	1.0	pF	$V_{IO} = 0, f = 1\text{MHz}$	
Rise time	$t_r$	-	5	18	$\mu\text{s}$	$V_{CE} = 2\text{V}, I_C = 2\text{mA}, R_L = 100\Omega$	
Fall time	$t_f$	-	3	18	$\mu\text{s}$		

\* Typical values at  $T_a = 25^\circ\text{C}$

Typical Electro-Optical Characteristics Curves

Figure 1. Forward Current vs Forward Voltage

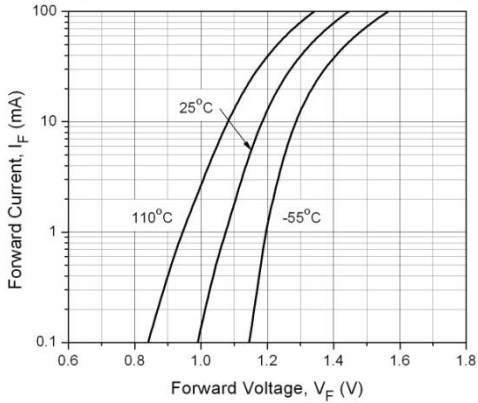

Figure 2. Normalized Collector Current vs Forward Current

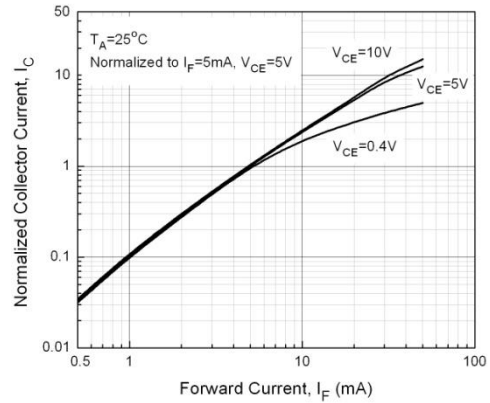

Figure 3. Normalized Current Transfer Ratio vs Forward Current

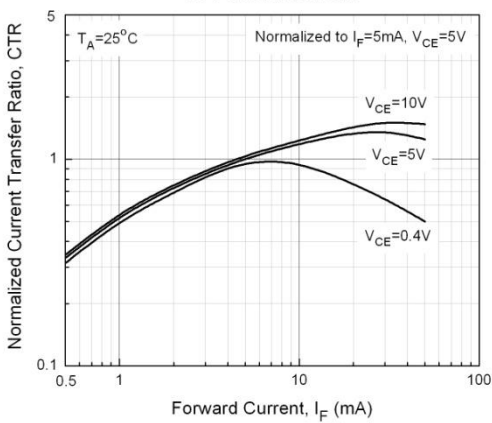

Figure 4. Normalized Collector Current vs Ambient Temperature

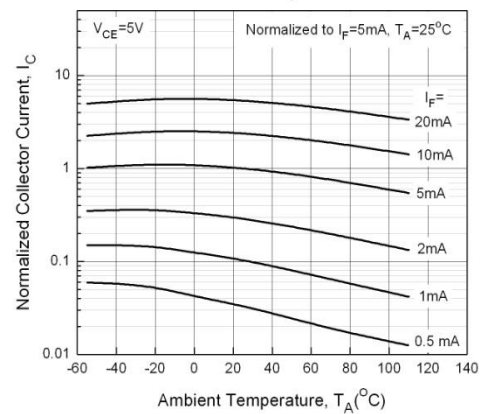

Figure 5. Normalized Current Transfer Ratio vs Ambient Temperature

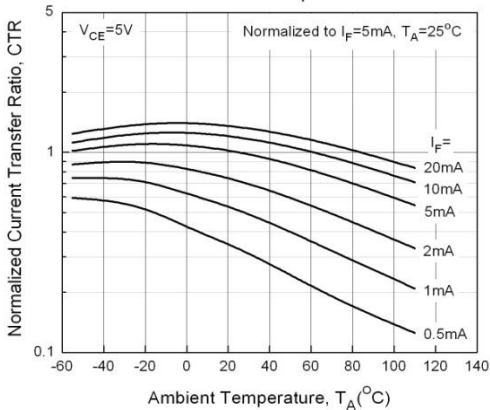

Figure 6. Collector Current vs Collector-Emitter Voltage

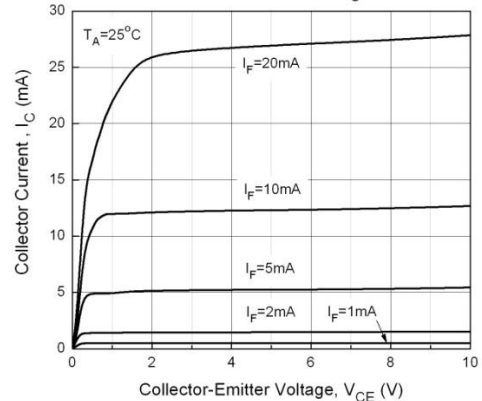

Figure 7. Collector Current vs Collector-Emitter Voltage

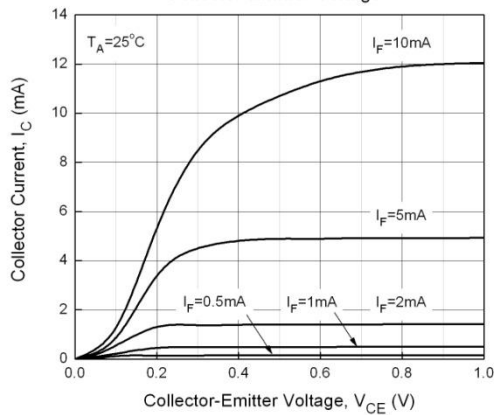

Figure 8. Collector Dark Current vs Ambient Temperature

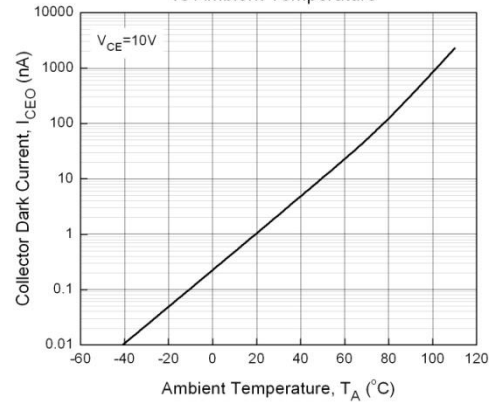

Figure 10. Switching Time vs Load Resistance

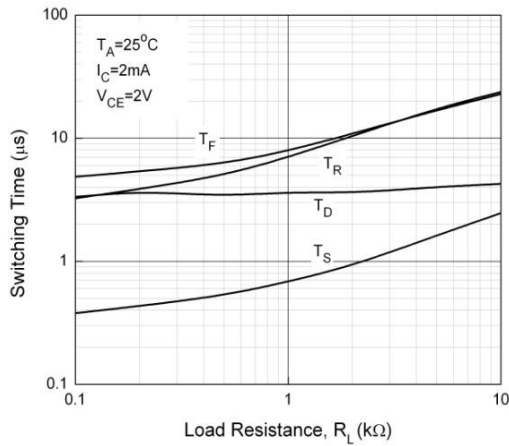

Figure 9. Collector-Emitter Saturation Voltage vs Ambient Temperature

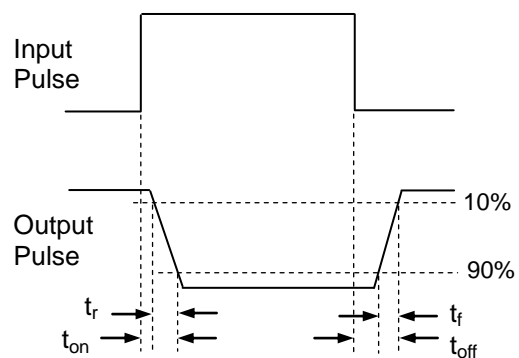
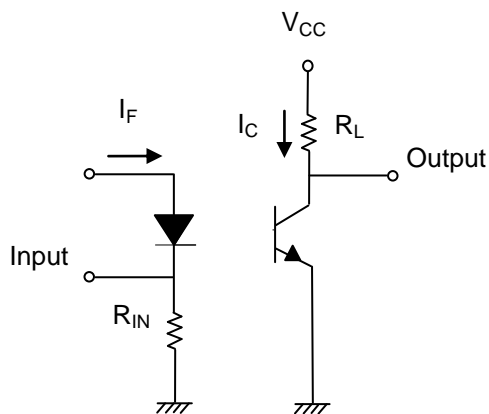
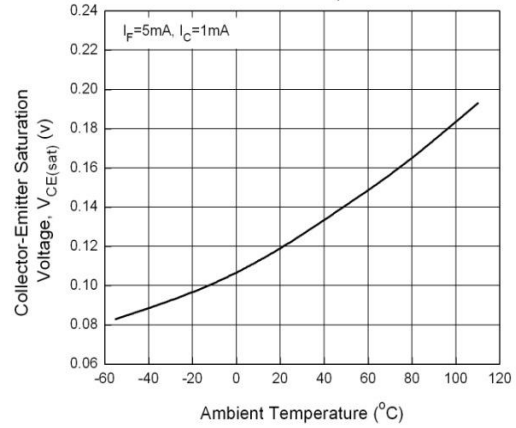

Figure 11. Switching Time Test Circuit & Waveforms

**Order Information**

**Part Number**

**EL3H7(X)(Y)-VG**

**Note**

- X** = CTR Rank (A, B, C, D, E, F, H, I, J, K or none)
- Y** = Tape and reel option (TA, TB, EA, EB or none)
- V** = VDE (optional)
- G** = Halogens free

Option	Description	Packing quantity
None	Standard SMD option	100 units per tube
-V	Standard SMD option + VDE	100 units per tube
(TA)	TA Tape & reel option	5000 units per reel
(TB)	TB Tape & reel option	5000 units per reel
(TA)-V	TA Tape & reel option + VDE	5000 units per reel
(TB)-V	TB Tape & reel option + VDE	5000 units per reel
(EA)	TA Tape & reel option	1000 units per reel
(EB)	TB Tape & reel option	1000 units per reel
(EA)-V	TA Tape & reel option + VDE	1000 units per reel
(EB)-V	TB Tape & reel option + VDE	1000 units per reel

Package Dimension (Dimensions in mm)

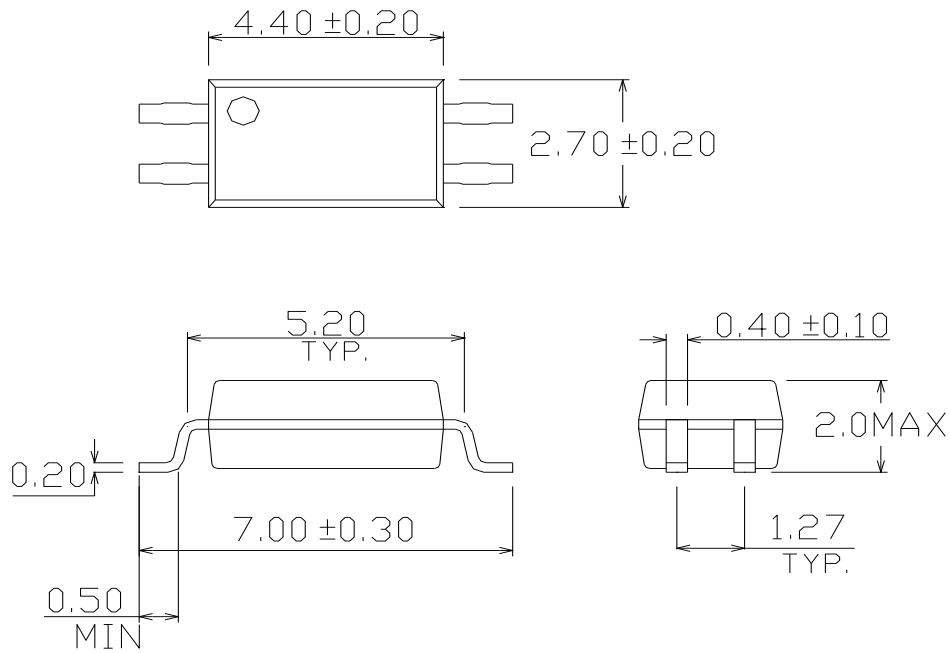

Recommended pad layout for surface mount leadform

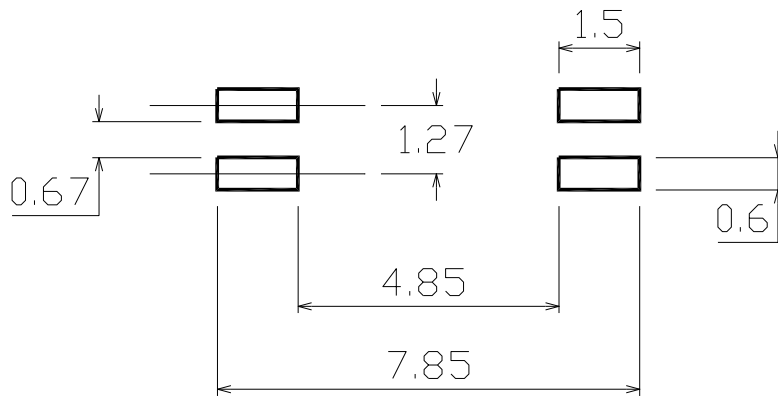

### Device Marking



### Notes

EL	denotes Everlight
3H7	denotes Device Number
R	denotes CTR Rank (A, B, C, D, E, F, H, I, J, K or none)
Y	denotes 1 digit Year code
WW	denotes 2 digit Week code
V	denotes VDE (optional)



**Tape & Reel Packing Specifications**

**Option TA**

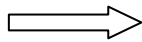
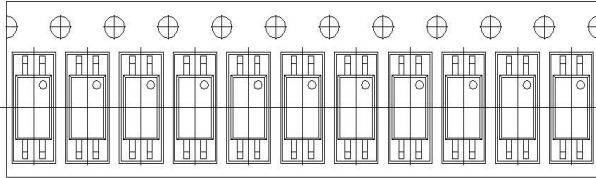

Direction of feed from reel

**Option TB**

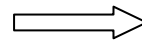
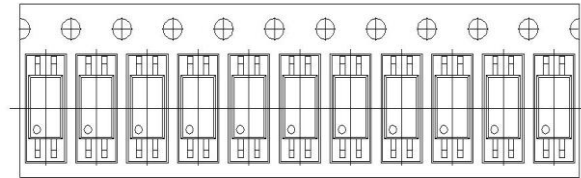

Direction of feed from reel

**Tape dimensions**

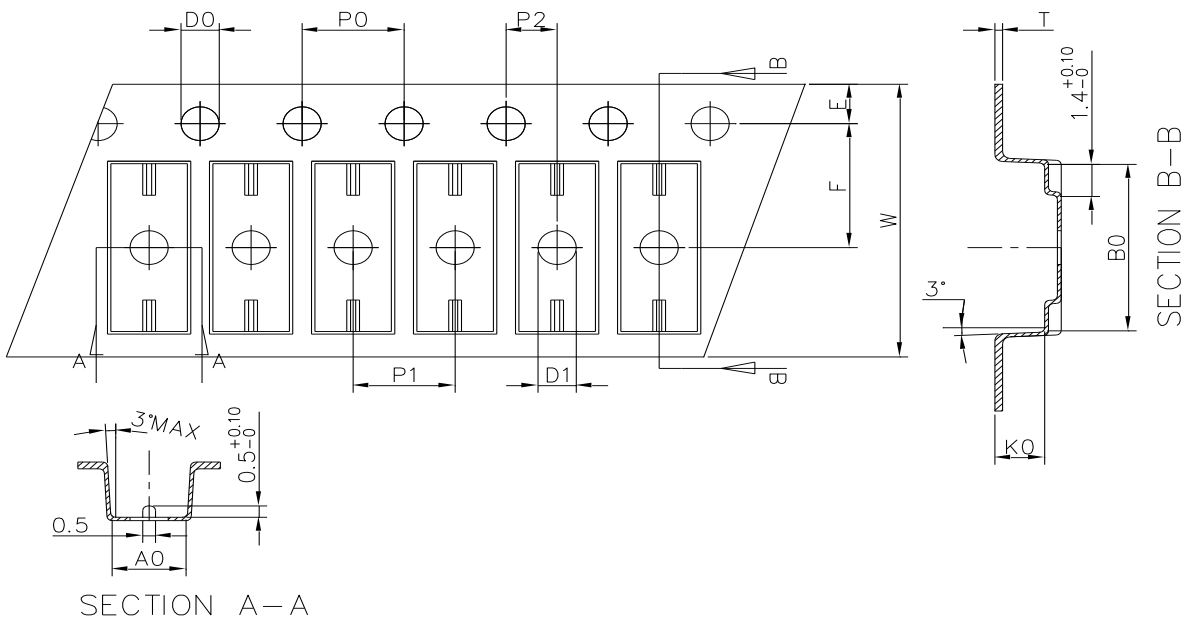

Dimension No.	<b>A0</b>	<b>B0</b>	<b>D0</b>	<b>D1</b>	<b>E</b>	<b>F</b>
Dimension (mm)	3.00 ± 0.10	7.45 ± 0.10	1.50 + 0.1/-0	1.50 ± 0.10	1.75 ± 0.10	5.50 ± 0.10
Dimension No.	<b>Po</b>	<b>P1</b>	<b>P2</b>	<b>t</b>	<b>W</b>	<b>K0</b>
Dimension (mm)	4.00 ± 0.15	4.00 ± 0.10	2.00 ± 0.10	0.30 ± 0.05	12.1 ± 0.2	2.45 ± 0.1

## Precautions for Use

### 1. Soldering Condition

#### 1.1 (A) Maximum Body Case Temperature Profile for evaluation of Reflow Profile

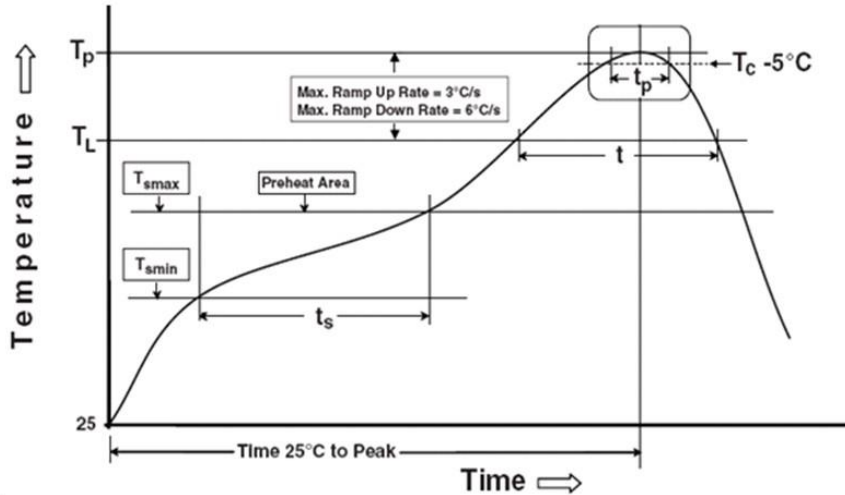

Note:

Reference: IPC/JEDEC J-STD-020D

#### Preheat

Temperature min ( $T_{smin}$ )	150 °C
Temperature max ( $T_{smax}$ )	200°C
Time ( $T_{smin}$ to $T_{smax}$ ) ( $t_s$ )	60-120 seconds
Average ramp-up rate ( $T_{smax}$ to $T_p$ )	3 °C/second max

#### Other

Liquidus Temperature ( $T_L$ )	217 °C
Time above Liquidus Temperature ( $t_L$ )	60-100 sec
Peak Temperature ( $T_p$ )	260°C
Time within 5 °C of Actual Peak Temperature: $T_p - 5^\circ\text{C}$	30 s
Ramp- Down Rate from Peak Temperature	6°C /second max.
Time 25°C to peak temperature	8 minutes max.
Reflow times	3 times

## **DISCLAIMER**

1. Above specification may be changed without notice. EVERLIGHT will reserve authority on material change for above specification.
2. When using this product, please observe the absolute maximum ratings and the instructions for using outlined in these specification sheets. EVERLIGHT assumes no responsibility for any damage resulting from use of the product which does not comply with the absolute maximum ratings and the instructions included in these specification sheets.
3. These specification sheets include materials protected under copyright of EVERLIGHT corporation. Please don't reproduce or cause anyone to reproduce them without EVERLIGHT's consent.

# Mouser Electronics

Authorized Distributor

Click to View Pricing, Inventory, Delivery & Lifecycle Information:

## Everlight:

[EL3H7\(A\)\(EA\)-G](#) [EL3H7\(A\)\(EA\)-VG](#) [EL3H7\(A\)\(EB\)-G](#) [EL3H7\(A\)\(EB\)-VG](#) [EL3H7\(A\)\(TA\)-G](#) [EL3H7\(A\)\(TA\)-VG](#)  
[EL3H7\(A\)\(TB\)-G](#) [EL3H7\(A\)\(TB\)-VG](#) [EL3H7\(A\)-G](#) [EL3H7\(A\)-VG](#) [EL3H7\(B\)\(EA\)-G](#) [EL3H7\(B\)\(EA\)-VG](#) [EL3H7\(B\)\(EB\)-G](#)  
[EL3H7\(B\)\(EB\)-VG](#) [EL3H7\(B\)\(TA\)-G](#) [EL3H7\(B\)\(TB\)-G](#) [EL3H7\(B\)\(TB\)-VG](#) [EL3H7\(B\)-G](#) [EL3H7\(B\)-VG](#)  
[EL3H7\(C\)\(EA\)-G](#) [EL3H7\(C\)\(EA\)-VG](#) [EL3H7\(C\)\(EB\)-G](#) [EL3H7\(C\)\(EB\)-VG](#) [EL3H7\(C\)\(TA\)-G](#) [EL3H7\(C\)\(TA\)-VG](#)  
[EL3H7\(C\)\(TB\)-G](#) [EL3H7\(C\)\(TB\)-VG](#) [EL3H7\(C\)-G](#) [EL3H7\(C\)-VG](#) [EL3H7\(D\)\(EA\)-G](#) [EL3H7\(D\)\(EA\)-VG](#)  
[EL3H7\(D\)\(EB\)-G](#) [EL3H7\(D\)\(EB\)-VG](#) [EL3H7\(D\)\(TA\)-VG](#) [EL3H7\(D\)\(TB\)-G](#) [EL3H7\(D\)\(TB\)-VG](#) [EL3H7\(D\)-G](#)  
[EL3H7\(E\)\(EA\)-G](#) [EL3H7\(E\)\(EA\)-VG](#) [EL3H7\(E\)\(EB\)-G](#) [EL3H7\(E\)\(EB\)-VG](#) [EL3H7\(E\)\(TA\)-G](#) [EL3H7\(E\)\(TA\)-VG](#)  
[EL3H7\(E\)\(TB\)-G](#) [EL3H7\(E\)\(TB\)-VG](#) [EL3H7\(E\)-G](#) [EL3H7\(E\)-VG](#) [EL3H7\(EA\)-G](#) [EL3H7\(EA\)-VG](#) [EL3H7\(EB\)-G](#) [EL3H7\(EB\)-VG](#)  
[EL3H7\(F\)\(EA\)-G](#) [EL3H7\(F\)\(EA\)-VG](#) [EL3H7\(F\)\(EB\)-G](#) [EL3H7\(F\)\(EB\)-VG](#) [EL3H7\(F\)\(TA\)-G](#) [EL3H7\(F\)\(TA\)-VG](#)  
[EL3H7\(F\)\(TB\)-G](#) [EL3H7\(F\)\(TB\)-VG](#) [EL3H7\(F\)-G](#) [EL3H7\(F\)-VG](#) [EL3H7\(H\)\(EA\)-G](#) [EL3H7\(H\)\(EA\)-VG](#) [EL3H7\(H\)\(EB\)-G](#)  
[EL3H7\(H\)\(EB\)-VG](#) [EL3H7\(H\)\(TA\)-G](#) [EL3H7\(H\)\(TA\)-VG](#) [EL3H7\(H\)\(TB\)-G](#) [EL3H7\(H\)\(TB\)-VG](#) [EL3H7\(H\)-G](#)  
[EL3H7\(H\)-VG](#) [EL3H7\(I\)\(EA\)-G](#) [EL3H7\(I\)\(EA\)-VG](#) [EL3H7\(I\)\(EB\)-G](#) [EL3H7\(I\)\(EB\)-VG](#) [EL3H7\(I\)\(TA\)-G](#) [EL3H7\(I\)\(TA\)-VG](#)  
[EL3H7\(I\)\(TB\)-G](#) [EL3H7\(I\)\(TB\)-VG](#) [EL3H7\(I\)-G](#) [EL3H7\(I\)-VG](#) [EL3H7\(J\)\(EA\)-G](#) [EL3H7\(J\)\(EA\)-VG](#) [EL3H7\(J\)\(EB\)-G](#)  
[EL3H7\(J\)\(EB\)-VG](#) [EL3H7\(J\)\(TA\)-G](#) [EL3H7\(J\)\(TA\)-VG](#) [EL3H7\(J\)\(TB\)-G](#) [EL3H7\(J\)\(TB\)-VG](#) [EL3H7\(J\)-G](#) [EL3H7\(J\)-VG](#)  
[EL3H7\(K\)\(EA\)-G](#) [EL3H7\(K\)\(EA\)-VG](#) [EL3H7\(K\)\(EB\)-G](#) [EL3H7\(K\)\(EB\)-VG](#) [EL3H7\(K\)\(TA\)-G](#) [EL3H7\(K\)\(TA\)-VG](#)  
[EL3H7\(K\)\(TB\)-G](#) [EL3H7\(K\)\(TB\)-VG](#) [EL3H7\(K\)-G](#) [EL3H7\(K\)-VG](#)