

# Features

# Switching Regulator

- Efficiency up to 95%, no heatsinks required
- Pin-out compatible with LM78XX linears
- Low profile (L/W/H=11.5 x 8.5 x 17.5mm)
- Wide input range
- Short circuit protection, thermal shutdown
- Low ripple and noise
- „L“ version with 90° pins



## R-78B-1.5(L)

1.5 Amp  
SIP3  
Single Output



### Description

The R-78Bxx-1.5 series high efficiency switching regulators are ideally suited to replace 78xx linear regulators and are pin compatible. The efficiency of up to 95% means that very little energy is wasted as heat so there is no need for any heat sinks with their additional space and mounting costs. The L-Version with 90° pins allows direct replacement for laid-flat regulators where component height is at a premium. Low ripple and noise figures and a short circuit input current of typically only 10mA round off the specifications of this versatile converter series.

### Selection Guide

Part Number	Input Voltage Range [VDC]	Output Voltage [VDC]	Output Current [A]	Efficiency	
				@ min Vin [%]	@ max. Vin [%]
R-78B1.5-1.5 <sup>(1)</sup>	4.75 - 18	1.5	1.5	83	78
R-78B1.8-1.5 <sup>(1)</sup>	4.75 - 18	1.8	1.5	85	81
R-78B2.5-1.5 <sup>(1)</sup>	4.75 - 18	2.5	1.5	88	84
R-78B3.3-1.5 <sup>(1)</sup>	4.75 - 18	3.3	1.5	91	88
R-78B5.0-1.5 <sup>(1)</sup>	6.5 - 18	5.0	1.5	94	92
R-78B6.5-1.5 <sup>(1)</sup>	8.0 - 18	6.5	1.5	95	93

### Model Numbering

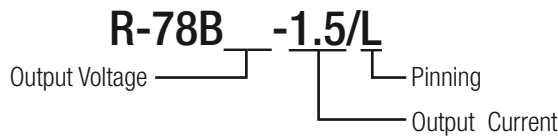

**Notes:**

Note1: add suffix "L" for 90° bent pins, e.g. R-78B5.0-1.5L

### Specifications (measured @ Ta= 25°C, 10% minimum load, unless otherwise stated)

BASIC CHARACTERISTICS					
Parameter	Condition		Min.	Typ.	Max.
Input Voltage Range	nom. Vin= 12VDC		4.75VDC		18VDC
Quiescent Current	nom. Vin= 12VDC			7mA	9mA
Internal Power Dissipation	Vout= 1.5VDC				0.65W
Internal Operating Frequency	nom. Vin= 12VDC		300kHz	340kHz	380kHz
Minimum Load <sup>(2)</sup>			0%		
Output Ripple and Noise <sup>(3)</sup>	10% to 100% full load	20MHz BW		15mVp-p	30mVp-p
Ref. Back Ripple Current				150mAp-p	200mAp-p
Absolute Maximum Capacitive Load	1 second start up, no external components				1000µF
	<1 second start up + diode protection circuit				6800µF

**Notes:**

Note2: Operation under no load will not harm the converter, but specifications may not be met

A minimum load of 10mA is recommended

Note3: Output Ripple and Noise is tested from 10% to 100% load

continued on next page

EN55032 compliant  
IEC/EN60950-1 certified

Specifications (measured @ Ta= 25°C, 10% minimum load, unless otherwise stated)

Efficiency vs. Vin (full load)

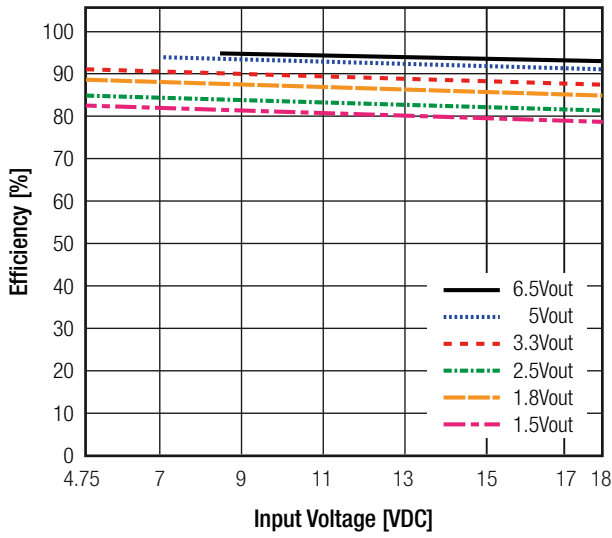

Ripple vs. Vin (full load)

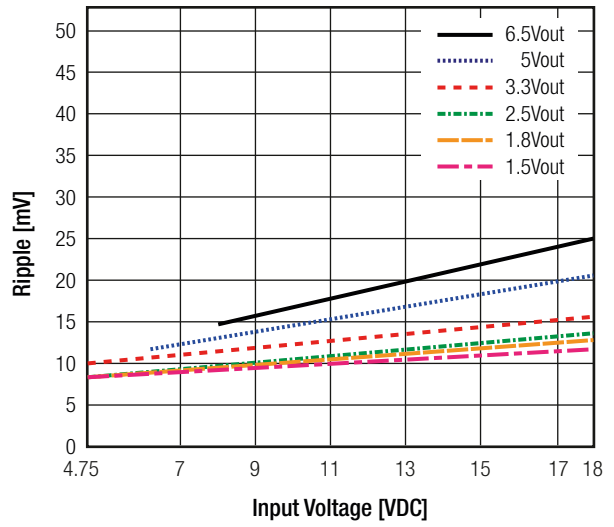

Efficiency vs. Load (max. Vin)

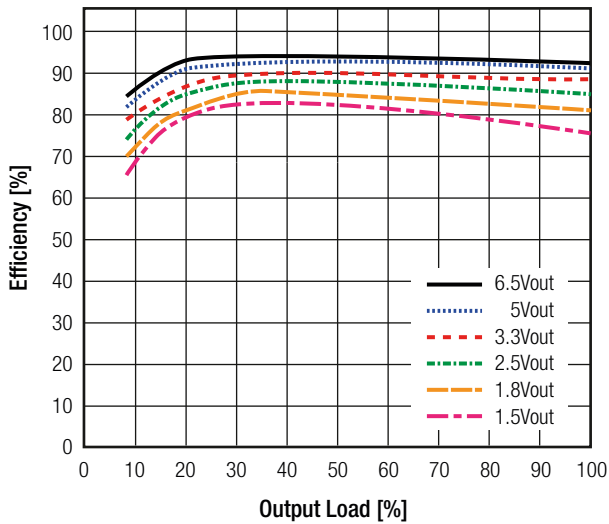

Ripple vs. Load (max. Vin)

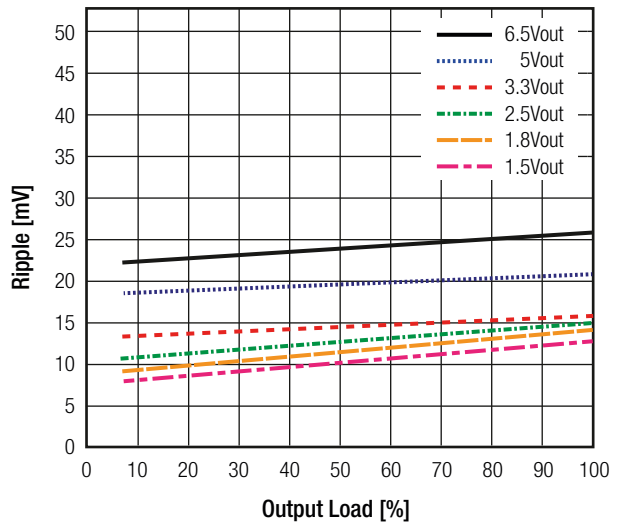

Efficiency vs. Load (min. Vin)

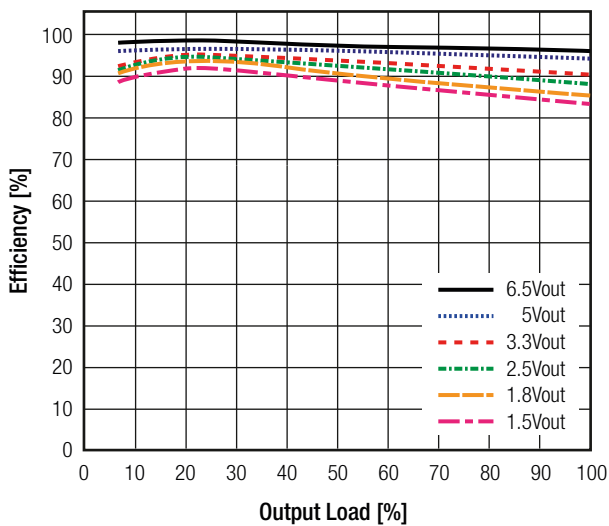

Ripple vs. Load (min. Vin)

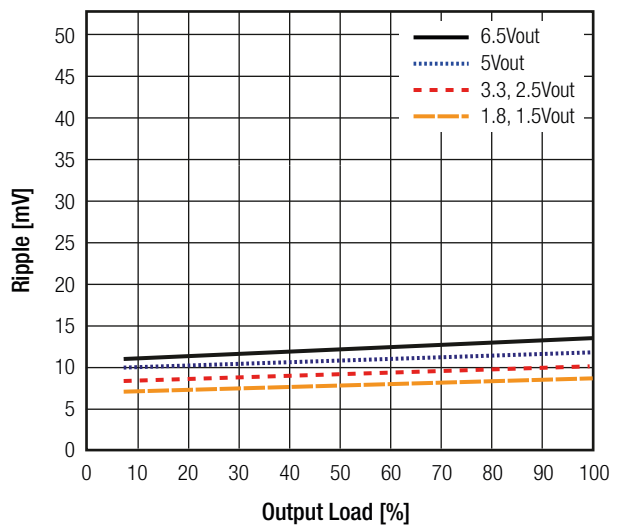

**Specifications** (measured @ Ta= 25°C, 10% minimum load, unless otherwise stated)

REGULATIONS		
Parameter	Condition	Value
Output Accuracy	100% load	±2.0% typ / ±3.0% max.
Line Regulation	low line to high line, full load	±0.3% typ. / ±0.5% max.
Load Regulation	10% to 100% load	±0.6% typ. / ±0.8% max.
Transient Response	100% <-> 50% load Recovery Time	±80mV typ. / ±120mV max. 1.0ms min. / 1.5ms typ.

PROTECTIONS		
Parameter	Condition	Value
Short Circuit Protection (SCP)	below 100mΩ	continuous, automatic recovery
Short Circuit Input Current	nom. Vin= 12VDC	100mA max.

**Optional Diode Protection Circuit**

Add a blocking diode to Vout if current can flow backwards into the output, as this can damage the converter when it is powered down.

The diode can either be fitted across the device if the source is low impedance or fitted in series with the output (recommended).

**Optional Protection 1:**

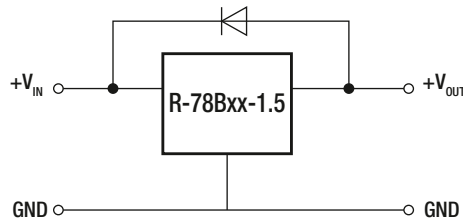

**Optional Protection 2:**

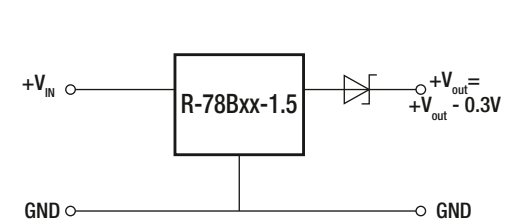

**ENVIRONMENTAL**

Parameter	Condition	Value
Operating Temperature Range	with derating (see graph)	-40°C to +85°C
Maximum Case Temperature		+100°C
Temperature Coefficient		±0.015%/°C
Thermal Impedance	0.1 m/s, vertical	60°C/W
Operating Altitude		2000m
Operating Humidity	non-condensing	95% RH max.
Pollution Degree		PD2
MTBF	according to MIL-HDBK-217F, G.B.	+25°C 5019 x 10 <sup>3</sup> hours

**Derating Graph**

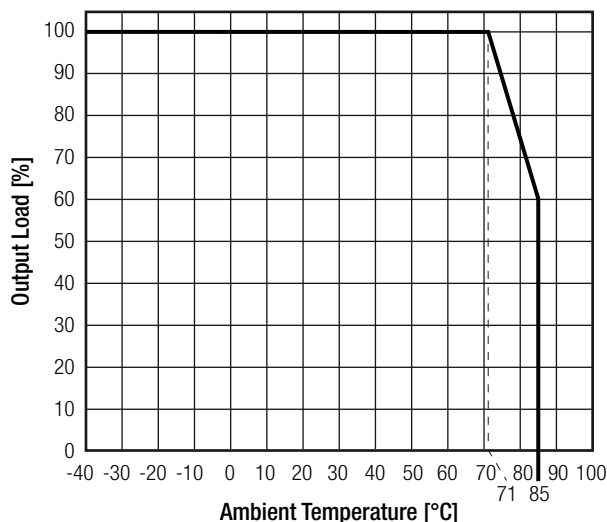

**Specifications** (measured @ Ta= 25°C, 10% minimum load, unless otherwise stated)

### SAFETY AND CERTIFICATIONS

Certificate Type (Safety)	Report / File Number	Standard
Information Technology Equipment, General Requirements for Safety	1603123	IEC60950-1:2005, 2nd Edition + AM 2:2013 EN60950-1:2006 + AM 2:2013
EAC	RU-AT.49.09571	TP TC 004/2011
RoHs 2+		RoHS 2011/65/EU + AM2015/863

### EMC Compliance

EMC Compliance	Condition	Standard / Criterion
Electromagnetic compatibility of multimedia equipment - Emission requirements	with external components	EN55032, Class A EN55032, Class B
ESD Electrostatic Discharge Immunity Test	Air ±8kV, Contact ±4kV	EN61000-4-2, Criteria A
Radiated, Radio-Frequency, Electromagnetic Field Immunity Test	3V/m	EN61000-4-3, Criteria A

### EMC Filter Suggestion according EN55032 Class A and Class B

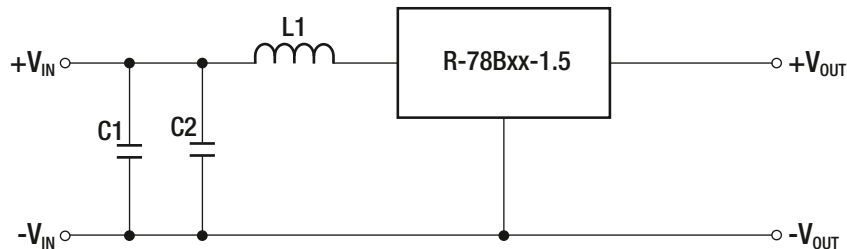

Level	C1	C2	L1
Class A	10µF 100V MLCC	-	3.9µH choke
Class B	10µF 100V MLCC	4.7µF 50V MLCC	5.6µH choke

### DIMENSION AND PHYSICAL CHARACTERISTICS

Parameter	Type	Value
Material	case potting	non-conductive black plastic, (UL94 V-0) silicone, (UL94 V-0)
Package Dimension (LxWxH)		11.5 x 8.5 x 17.5mm
Package Weight		4g typ.

continued on next page

Specifications (measured @ Ta= 25°C, 10% minimum load, unless otherwise stated)

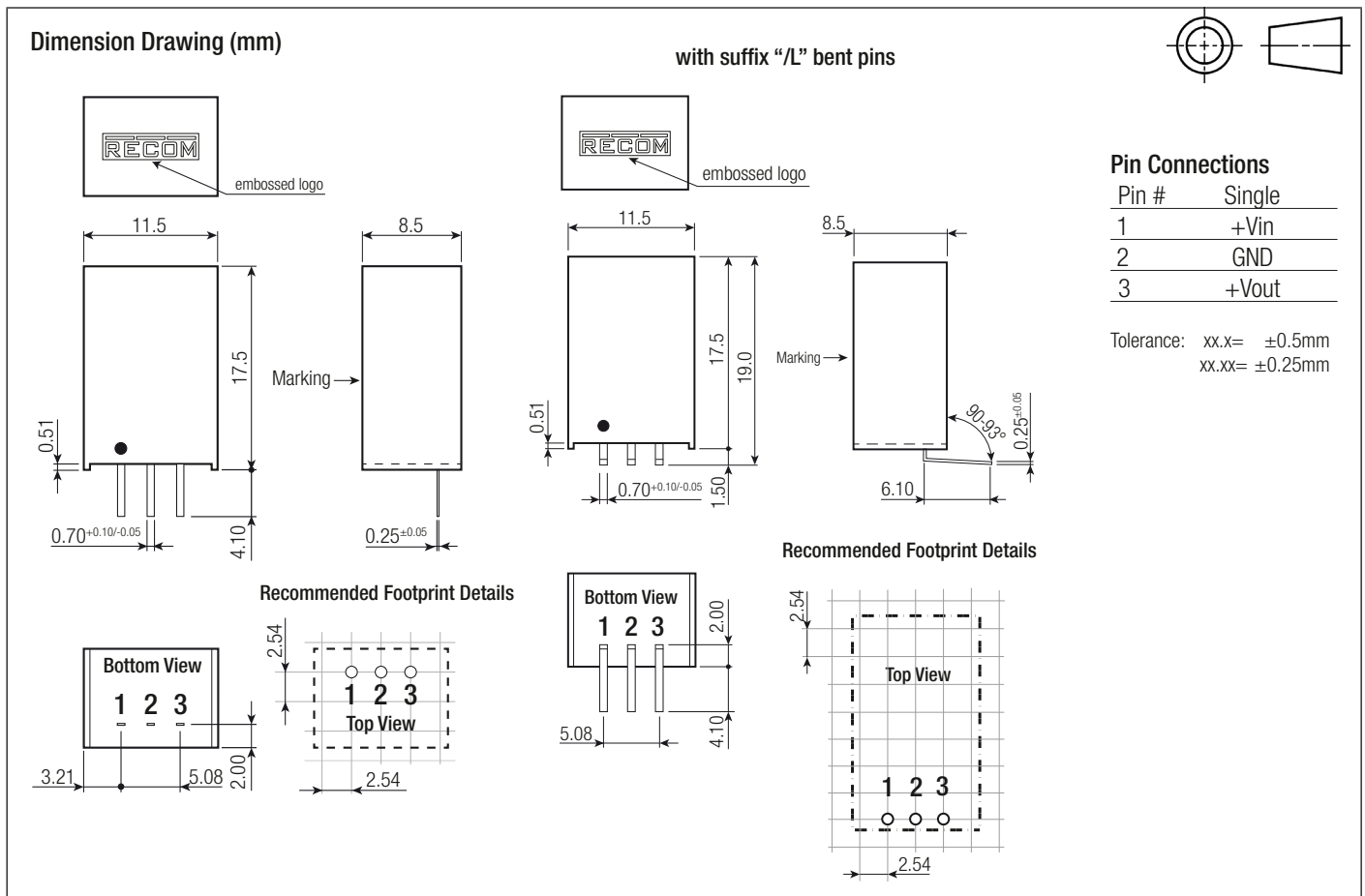

### INSTALLATION AND APPLICATION

#### Typical Application Circuit

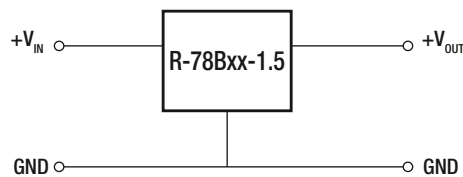

#### Application Examples

##### High Efficiency Multiple Output

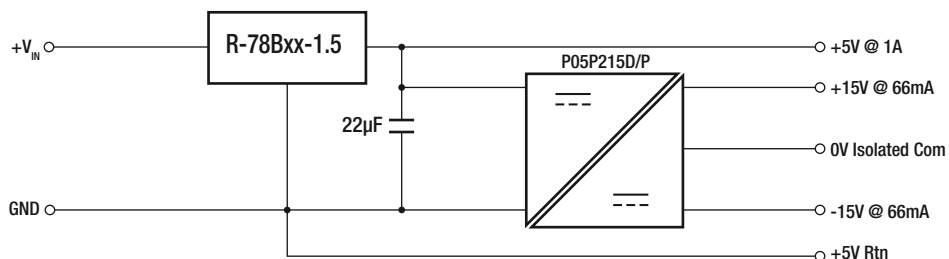

- Wide input range suits both 12V and 7.2V battery packs
- 5.2kV isolated short circuit protected outputs for analogue circuits, e.g. medical grade interface
- High efficiency +5V/1A protected output for digital circuits
- Further decoupling filtering may be necessary between the converters

continued on next page

**Specifications** (measured @ Ta= 25°C, 10% minimum load, unless otherwise stated)

**Isolated, Wide Input Range, Distributed Power Architecture (Point-of-Load)**

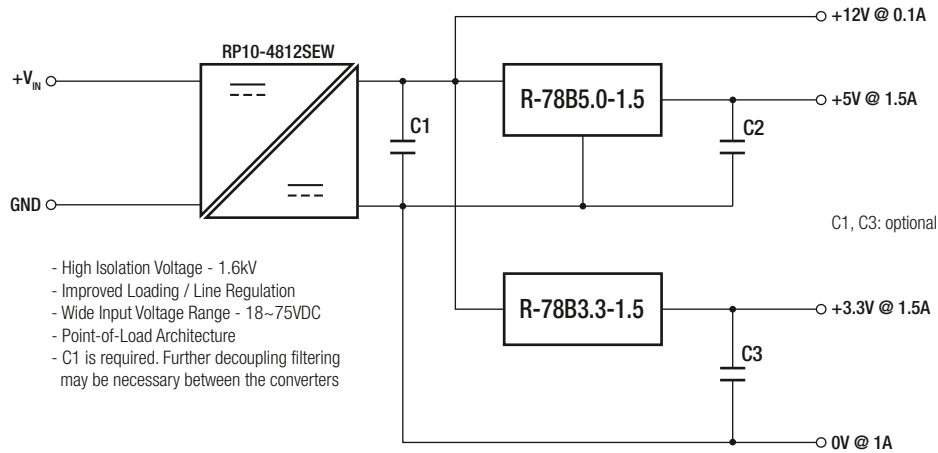

**PACKAGING INFORMATION**

Parameter	Type		Value
	tube	without suffix with suffix "L"	
Packaging Dimension (LxWxH)			520.0 x 25.1 x 10.6mm 520.0 x 26.1 x 15.8mm
Packaging Quantity	tube		42pcs
Storage Temperature Range			-55°C to +125°C
Storage Humidity			95% RH max.

The product information and specifications may be subject to changes even without prior written notice. The product has been designed for various applications; its suitability lies in the responsibility of each customer. The products are not authorized for use in safety-critical applications without RECOM's explicit written consent. A safety-critical application is an application where a failure may reasonably be expected to endanger or cause loss of life, inflict bodily harm or damage property. The applicant shall indemnify and hold harmless RECOM, its affiliated companies and its representatives against any damage claims in connection with the unauthorized use of RECOM products in such safety-critical applications.

# Mouser Electronics

Authorized Distributor

Click to View Pricing, Inventory, Delivery & Lifecycle Information:

## RECOM:

[R-78B3.3-1.5](#) [R-78B5.0-1.5](#) [R-78B1.5-1.5](#) [R-78B1.5-1.5L](#) [R-78B1.8-1.5](#) [R-78B1.8-1.5L](#) [R-78B2.5-1.5](#) [R-78B2.5-1.5L](#) [R-78B3.3-1.5L](#) [R-78B5.0-1.5L](#) [R-78B6.5-1.5](#) [R-78B6.5-1.5L](#)