



LOW-POWER RS-485 FULL-DUPLEX DRIVERS/RECEIVERS

 Check for Samples: [SN65HVD3080E](#), [SN65HVD3083E](#), [SN65HVD3086E](#)

FEATURES

- **Low Quiescent Power**
 - 375 μA (Typical) Enabled Mode
 - 2 nA (Typical) Shutdown Mode
- **Small MSOP Package**
- **1/8 Unit-Load—Up to 256 Nodes per Bus**
- **16 kV Bus-Pin ESD Protection, 6 kV All Pins**
- **Failsafe Receiver (Bus Open, Short, Idle)**
- **TIA/EIA-485A Standard Compliant**
- **RS-422 Compatible**
- **Power-Up, Power-Down Glitch-Free Operation**

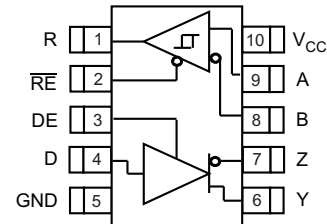
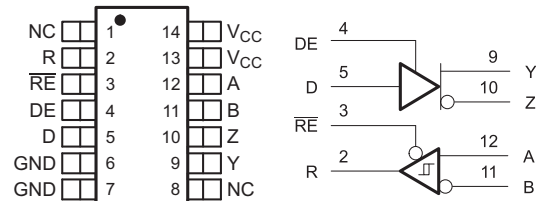
**DGS PACKAGE
(TOP VIEW)**

**D PACKAGE
(TOP VIEW)**

NC - No internal connection
Pins 6 and 7 are connected together internally
Pins 13 and 14 are connected together internally

APPLICATIONS

- **Motion Controllers**
- **Point-of-Sale (POS) Terminals**
- **Rack-to-Rack Communications**
- **Industrial Networks**
- **Power Inverters**
- **Battery-Powered Applications**
- **Building Automation**

DESCRIPTION

Each of these devices is a balanced driver and receiver designed for full-duplex RS-485 or RS-422 data bus networks. Powered by a 5-V supply, they are fully compliant with the TIA/EIA-485A standard.

With controlled bus output transition times, the devices are suitable for signaling rates from 200 kbps to 20 Mbps.

The devices are designed to operate with a low supply current, less than 1 mA (typical), exclusive of the load. When in the inactive shutdown mode, the supply current drops to a few nanoamps, making these devices ideal for power-sensitive applications.

The wide common-mode range and high ESD protection levels of these devices make them suitable for demanding applications such as motion controllers, electrical inverters, industrial networks, and cabled chassis interconnects where noise tolerance is essential.

These devices are characterized for operation over the temperature range -40°C to 85°C

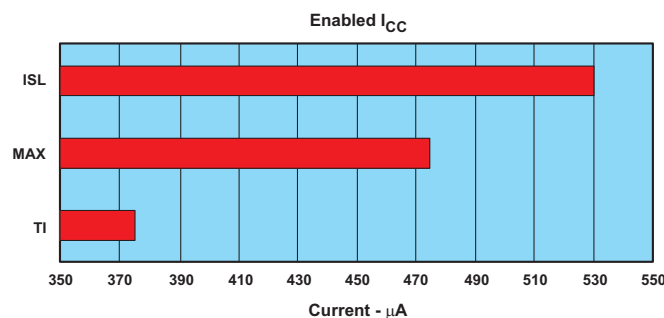

Please be aware that an important notice concerning availability, standard warranty, and use in critical applications of Texas Instruments semiconductor products and disclaimers thereto appears at the end of this data sheet.



This integrated circuit can be damaged by ESD. Texas Instruments recommends that all integrated circuits be handled with appropriate precautions. Failure to observe proper handling and installation procedures can cause damage.

ESD damage can range from subtle performance degradation to complete device failure. Precision integrated circuits may be more susceptible to damage because very small parametric changes could cause the device not to meet its published specifications.

ORDERING INFORMATION

PART NUMBER	SIGNALING RATE	PACKAGE ⁽¹⁾	MARKED AS
SN65HVD3080E	200 kbps	DGS, DGSR 10-pin MSOP ⁽²⁾	BTT
SN65HVD3083E	1 Mbps		BTU
SN65HVD3086E	20 Mbps		D 14-pin SOIC
		HVD3086	

(1) For the most current package and ordering information, see the Package Option Addendum at the end of this document, or see the TI website at www.ti.com.

(2) The R suffix indicated tape and reel.

ABSOLUTE MAXIMUM RATINGS

over operating free-air temperature range unless otherwise noted⁽¹⁾

		UNIT
V_{CC}	Supply voltage range ⁽²⁾	-0.3 V to 7 V
$V_{(A)}, V_{(B)}, V_{(Y)}, V_{(Z)}$	Voltage range at any bus terminal (A, B, Y, Z)	-9 V to 14 V
$V_{(TRANS)}$	Voltage input, transient pulse through 100 Ω . See Figure 10 (A, B, Y, Z)	-50 to 50 V
V_I	Input voltage range (D, DE, \overline{RE})	-0.3 V to $V_{CC}+0.3$ V
P_D	Continuous total power dissipation	See the dissipation rating table
T_J	Junction temperature	170°C

(1) Stresses beyond those listed under absolute maximum ratings may cause permanent damage to the device. These are stress ratings only, and functional operation of the device at these or any other conditions beyond those indicated under recommended operating conditions is not implied. Exposure to absolute-maximum-rated conditions for extended periods may affect device reliability.

(2) All voltage values, except differential I/O bus voltages, are with respect to network ground terminal.

POWER DISSIPATION RATINGS

PACKAGE	$T_A < 25^\circ\text{C}$	DERATING FACTOR ⁽¹⁾ ABOVE $T_A < 25^\circ\text{C}$	$T_A = 85^\circ\text{C}$
10-pin MSOP (DGS)	463 mW	3.71 mW/°C	241 mW
14-pin SOIC (D)	765 mW	6.1 mW/°C	400 mW

(1) This is the inverse of the junction-to-ambient thermal resistance when board-mounted and with no air flow.

ELECTROSTATIC DISCHARGE PROTECTION

PARAMETER	TEST CONDITIONS	MIN	TYP	MAX	UNIT
Human Body Model ⁽¹⁾	A,B,Y,Z, and GND		16		kV
	All pins		6		kV
Charged Device Mode ⁽²⁾	All pins		1.5		kV
Machine Model ⁽³⁾	All pins		400		V

(1) Tested in accordance JEDEC Standard 22, Test Method A114-A. Bus pin stressed with respect to a common connection of GND and V_{CC} .

(2) Tested in accordance JEDEC Standard 22, Test Method C101.

(3) Tested in accordance JEDEC Standard 22, Test Method A115.

SUPPLY CURRENT

over recommended operating conditions unless otherwise noted

PARAMETER		TEST CONDITIONS	MIN	TYP	MAX	UNIT
I_{CC}	Supply current	\overline{RE} at 0 V, D and DE at V_{CC} , No load		375	750	μA
		\overline{RE} at 0 V, D and DE at 0 V, No load		300	680	μA
		\overline{RE} at V_{CC} , D and DE at V_{CC} , No load		240	600	μA
		\overline{RE} and D at V_{CC} , DE at 0 V, No load		2	1000	nA

RECOMMENDED OPERATING CONDITIONS

over operating free-air temperature range unless otherwise noted

		MIN	NOM	MAX	UNIT	
V_{CC}	Supply voltage	4.5	5	5.5	V	
V_I or V_{IC}	Voltage at any bus terminal (separately or common mode)	$-7^{(1)}$		12	V	
V_{IH}	High-level input voltage	D, DE, \overline{RE}		V_{CC}	V	
V_{IL}	Low-level input voltage	D, DE, \overline{RE}		0.8	V	
V_{ID}	Differential input voltage			-12	12	V
		Dynamic, See Figure 11				V
I_{OH}	High-level output current	Driver		-60		mA
		Receiver		-10		
I_{OL}	Low-level output current	Driver			60	mA
		Receiver			10	
T_J	Junction temperature			150	$^{\circ}C$	
T_A	Ambient still-air temperature	-40		85		

(1) The algebraic convention, in which the least positive (most negative) limit is designated as minimum is used in this data sheet.

DRIVER ELECTRICAL CHARACTERISTICS

over recommended operating conditions unless otherwise noted

PARAMETER		TEST CONDITIONS	MIN	TYP	MAX	UNIT
V _{OD}	Differential output voltage	No load, I _O = 0	3	4.3	V _{CC}	V
		R _L = 54 Ω, See Figure 1	1.5	2.3		
		V _{test} = -7 V to 12 V, See Figure 2	1.5			
		R _L = 100 Ω, See Figure 1	2			
Δ V _{OD}	Change in magnitude of differential output voltage	R _L = 54 Ω, See Figure 1 and Figure 2	-0.2	0	0.2	V
V _{OC(SS)}	Steady-state common-mode output voltage	See Figure 3	1	2.6	3	V
ΔV _{OC(SS)}	Common-mode output voltage (Dominant)		-0.1	0	0.1	
V _{OC(PP)}	Peak-to-peak common-mode output voltage		0.5			
I _{Z(Y)} or I _{Z(Z)}	High-impedance state output current		V _{CC} = 0 V, V _(Z) or V _(Y) = 12 V Other input at 0 V			
		V _{CC} = 0 V, V _(Z) or V _(Y) = -7 V Other input at 0 V	-1			
		V _{CC} = 5 V, V _(Z) or V _(Y) = 12 V Other input at 0 V			1	
		V _{CC} = 5 V, V _(Z) or V _(Y) = -7 V Other input at 0 V	-1			
I _I	Input current	D, DE	-100		100	μA
I _{OS}	Short-circuit output current	-7 V ≤ V _O ≤ 12 V	-250		250	mA

DRIVER SWITCHING CHARACTERISTICS

over recommended operating conditions unless otherwise noted

PARAMETER		TEST CONDITIONS	MIN	TYP	MAX	UNIT	
t _{PLH} , t _{PHL}	Propagation delay time, low-to-high-level output Propagation delay time, high-to-low-level output	HVD3080E		0.7	1.3	μs	
		HVD3083E		150	500	ns	
		HVD3086E		12	20	ns	
t _r , t _f	Differential output signal rise time Differential output signal fall time	HVD3080E	R _L = 54 Ω, C _L = 50 pF, See Figure 4	0.5	0.9	1.5	μs
		HVD3083E		200	300	ns	
		HVD3086E		7	15	ns	
t _{sk(p)}	Pulse skew (t _{PHL} - t _{PLH})	HVD3080E		20	200	ns	
		HVD3083E		5	50	ns	
		HVD3086E		1.4	5	ns	
t _{PZH}	Propagation delay time, high-impedance-to-high-level output	HVD3080E	R _L = 110 Ω, R _E at 0 V, See Figure 5	2.5	7	μs	
		HVD3083E		1	2.5	μs	
		HVD3086E		13	30	ns	
t _{PHZ}	Propagation delay time, high-level-to-high-impedance output	HVD3080E		80	200	ns	
		HVD3083E		60	100	ns	
		HVD3086E		12	30	ns	
t _{PZL}	Propagation delay time, high-impedance-to-low-level output	HVD3080E		2.5	7	μs	
		HVD3083E		1	2.5	μs	
		HVD3086E		13	30	ns	
t _{PLZ}	Propagation delay time, low-level-to-high-impedance output	HVD3080E		80	200	ns	
		HVD3083E		60	100	ns	
		HVD3086E		12	30	ns	
t _{PZH} , t _{PZL}	Propagation delay time, standby-to-high-level output (See Figure 5) Propagation delay time, standby-to-low-level output (See Figure 6)	R _L = 110 Ω, R _E at 3 V		3.5	7	μs	

RECEIVER ELECTRICAL CHARACTERISTICS

over recommended operating conditions unless otherwise noted

PARAMETER		TEST CONDITIONS	MIN	TYP ⁽¹⁾	MAX	UNIT	
V _{IT+}	Positive-going differential input threshold voltage	I _O = -10 mA	-0.08		-0.01	V	
V _{IT-}	Negative-going differential input threshold voltage	I _O = 10 mA	-0.2	-0.1			
V _{hys}	Hysteresis voltage (V _{IT+} - V _{IT-})			30		mV	
V _{OH}	High-level output voltage	V _{ID} = 200 mV, I _{OH} = -10 mA, See Figure 7 and Figure 8	4	4.6		V	
V _{OL}	Low-level output voltage	V _{ID} = -200 mV, I _{OH} = 10 mA, See Figure 7 and Figure 8		0.15	0.4	V	
I _{OZ}	High-impedance-state output current	V _O = 0 or V _{CC}	-1		1	μA	
I _I	Bus input current	Other input at 0V	V _A or V _B = 12 V		0.04	0.11	mA
			V _A or V _B = 12 V, V _{CC} = 0 V		0.06	0.13	
			V _A or V _B = -7 V		-0.1	-0.04	
			V _A or V _B = -7 V, V _{CC} = 0 V		-0.05	-0.03	
I _{IH}	High-level input current	V _{IH} = 2 V	-60	-30		μA	
I _{IL}	Low-level input current	V _{IL} = 0.8 V	-60	-30		μA	
C _{ID}	Differential input capacitance	V _I = 0.4 sin (4E6πt) + 0.5 V		7		pF	

(1) All typical values are at 25°C and with a 3.3-V supply.

RECEIVER SWITCHING CHARACTERISTICS

over recommended operating conditions unless otherwise noted

PARAMETER		TEST CONDITIONS	MIN	TYP	MAX	UNIT
t _{PLH}	Propagation delay time, low-to-high-level output	V _{ID} = -1.5 V to 1.5 V, C _L = 15 pF, See Figure 8		75	100	ns
t _{PHL}	Propagation delay time, high-to-low-level output			79	100	
t _{sk(p)}	Pulse skew ((t _{PHL} - t _{PLH}))			4	10	
t _r	Output signal rise time			1.5	3	
t _f	Output signal fall time			1.8	3	
t _{PZH} , t _{PZL}	Output enable time	DE at V _{CC} , See Figure 9		10	50	ns
		From standby DE at GND, See Figure 9		1.7	3.5	μs
t _{PHZ} , t _{PLZ}	Output disable time	DE at GND or V _{CC} , See Figure 9		7	50	ns

PARAMETER MEASUREMENT INFORMATION

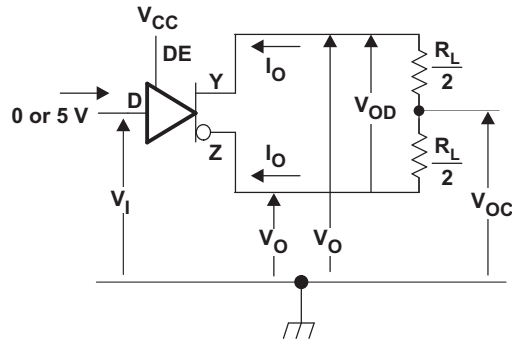

Figure 1. Driver V_{OD} Test Circuit and Current Definitions

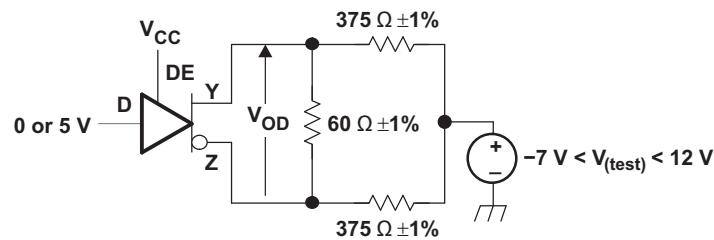

Figure 2. Driver V_{OD} With Common-Mode Loading Test Circuit

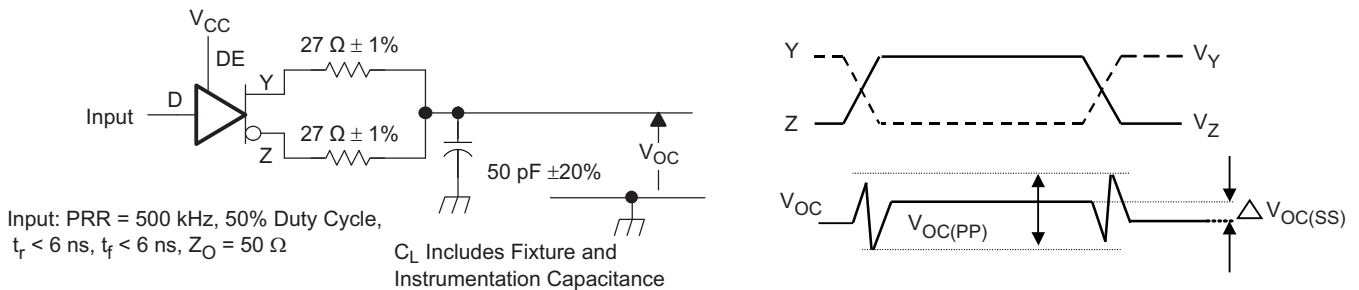

Figure 3. Test Circuit and Definitions for the Driver Common-Mode Output Voltage

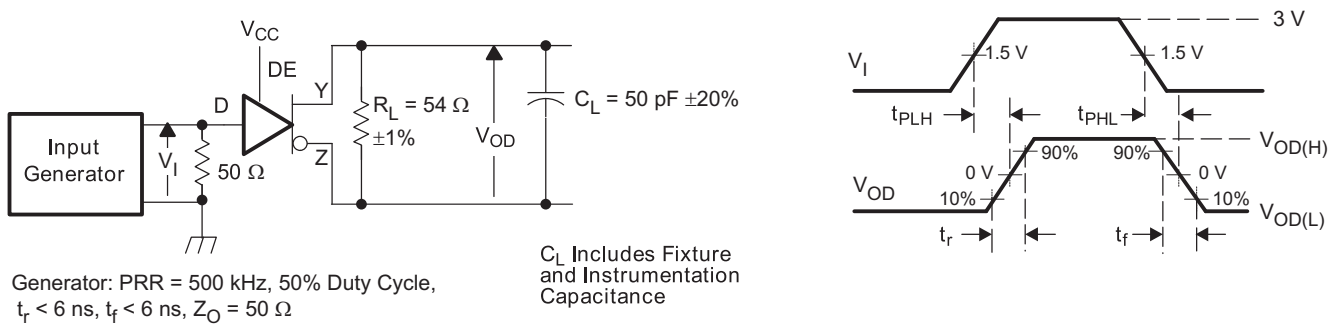

Figure 4. Driver Switching Test Circuit and Voltage Waveforms

PARAMETER MEASUREMENT INFORMATION (continued)

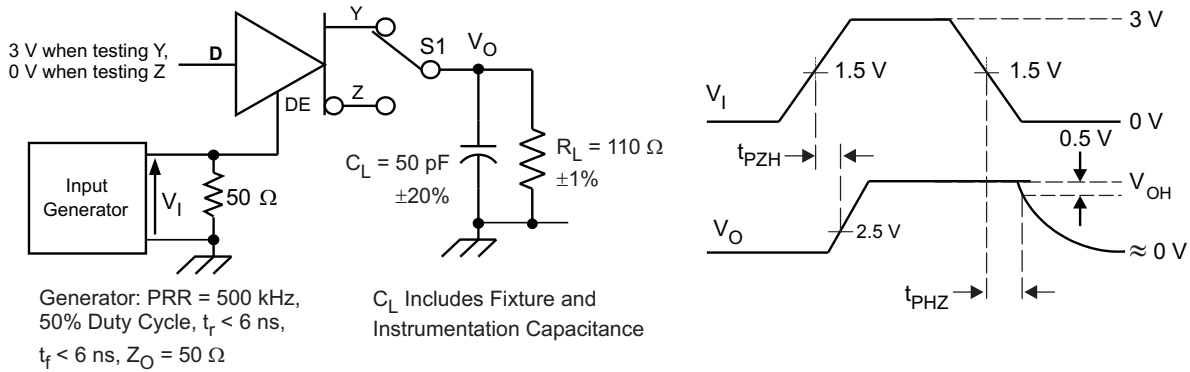

Figure 5. Driver High-Level Output Enable and Disable Time Test Circuit and Voltage Waveforms

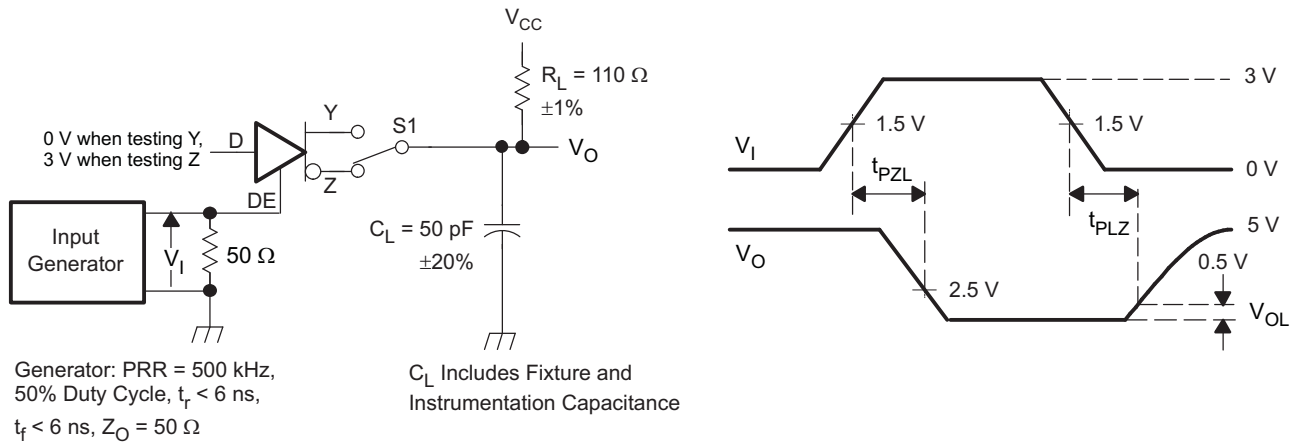

Figure 6. Driver Low-Level Output Enable and Disable Time Test Circuit and Voltage Waveforms

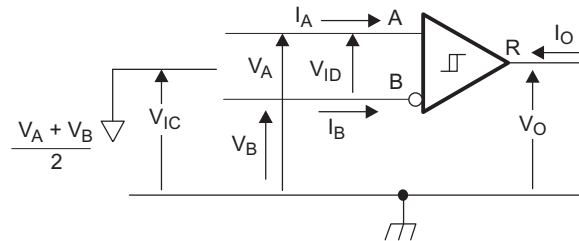

Figure 7. Receiver Voltage and Current Definitions

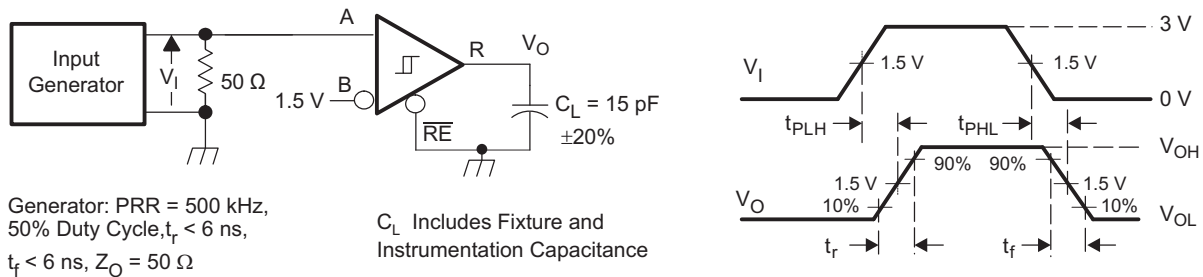

Figure 8. Receiver Switching Test Circuit and Voltage Waveforms

DEVICE INFORMATION

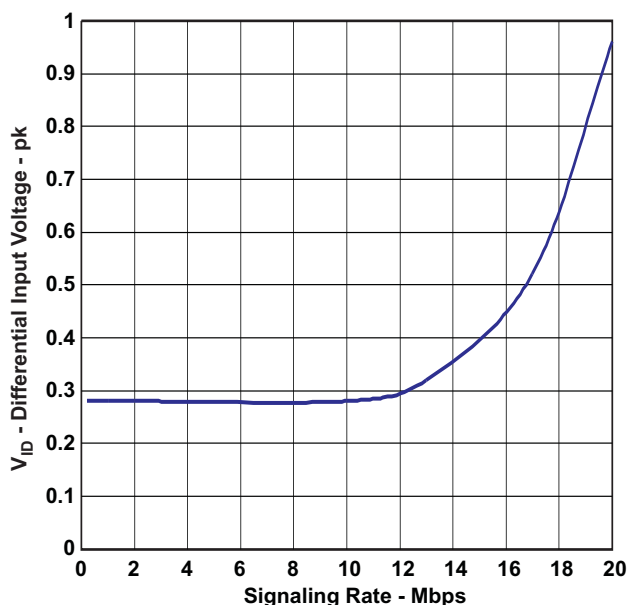

Figure 11. Recommended Minimum Differential Input Voltage vs Signaling Rate

FUNCTION TABLES

DRIVER⁽¹⁾

INPUT	ENABLE	OUTPUTS	
D	DE	Y	Z
H	H	H	L
L	H	L	H
X	L or OPEN	Z	Z
Open	H	H	L

(1) H = high level, L = low level, Z = high impedance, X = irrelevant, ? = indeterminate

RECEIVER⁽¹⁾

DIFFERENTIAL INPUTS $V_{ID} = V_{(A)} - V_{(B)}$	ENABLE \overline{RE}	OUTPUT R
$V_{ID} \leq -0.2\text{ V}$	L	L
$-0.2\text{ V} < V_{ID} < -0.01\text{ V}$	L	?
$-0.01\text{ V} \leq V_{ID}$	L	H
X	H or OPEN	Z
Open Circuit	L	H
BUS Idle	L	H
Short Circuit	L	H

(1) H = high level, L = low level, Z = high impedance, X = irrelevant, ? = indeterminate

DEVICE ELECTRICAL CHARACTERISTICS

over operating free-air temperature range (unless otherwise noted)

	PARAMETERS	TEST CONDITIONS	MIN	TYP	MAX	UNIT
$P_{(AVG)}$	Average power dissipation	$R_L = 60 \Omega$, Input to D a 500-kHz 50% duty cycle square-wave	85	109	136	mW

EQUIVALENT INPUT AND OUTPUT SCHEMATIC DIAGRAMS

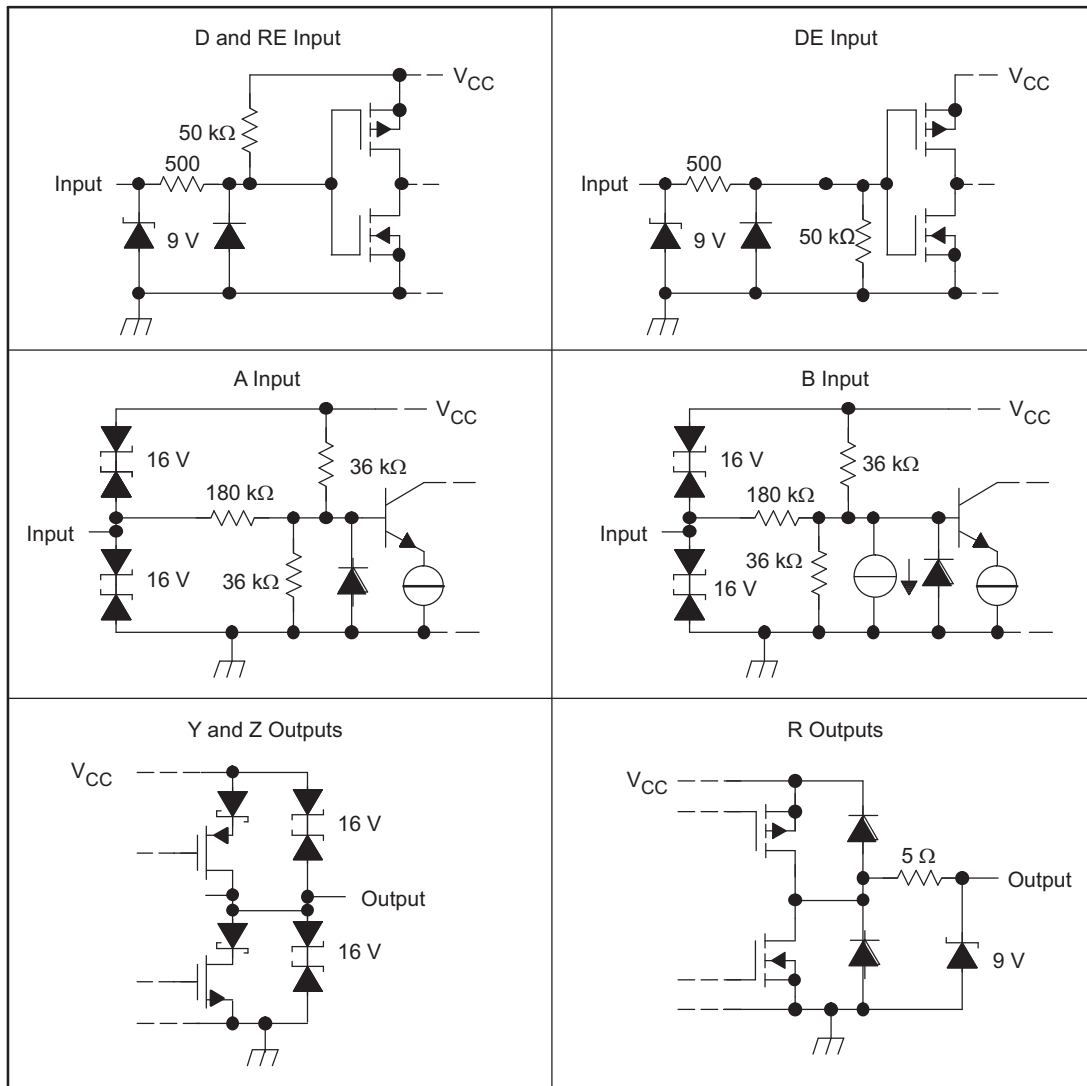

TYPICAL CHARACTERISTICS

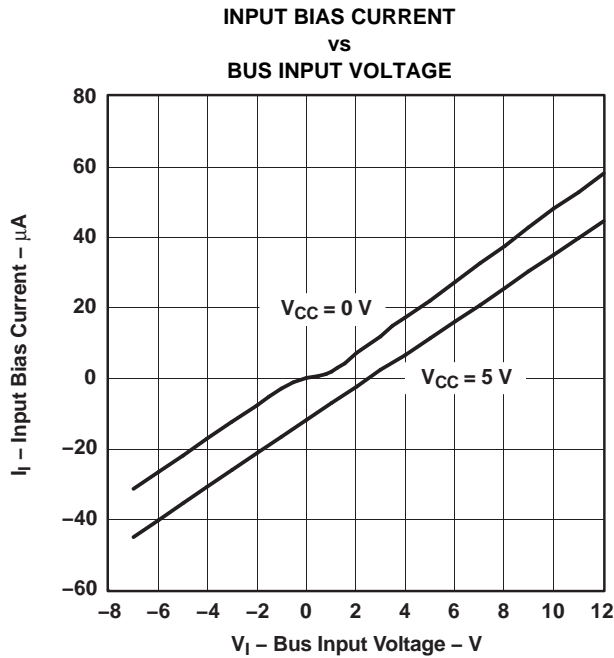

Figure 12.

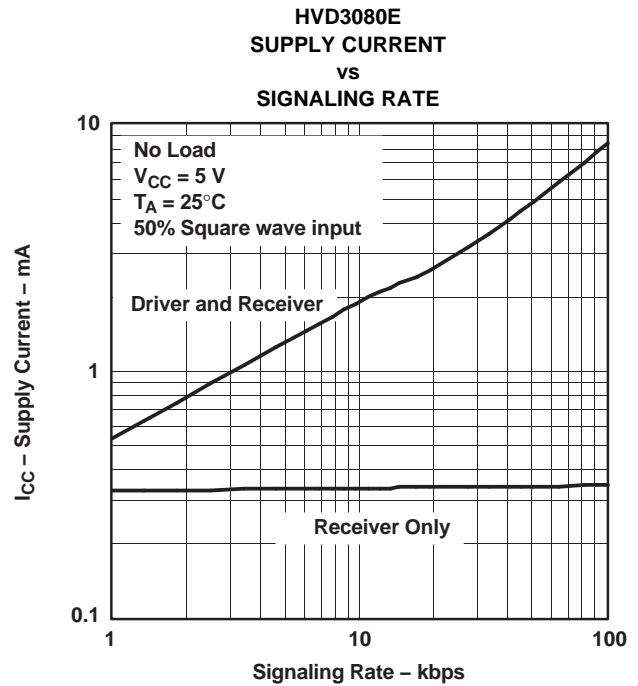

Figure 13.

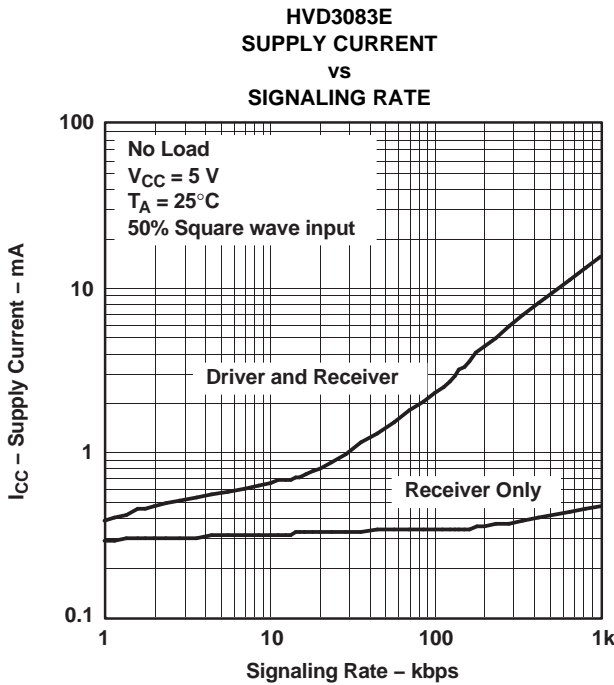

Figure 14.

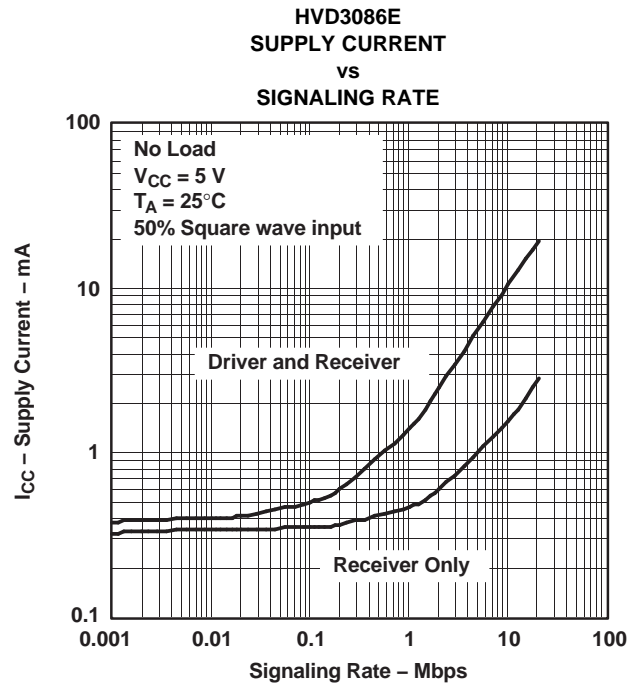
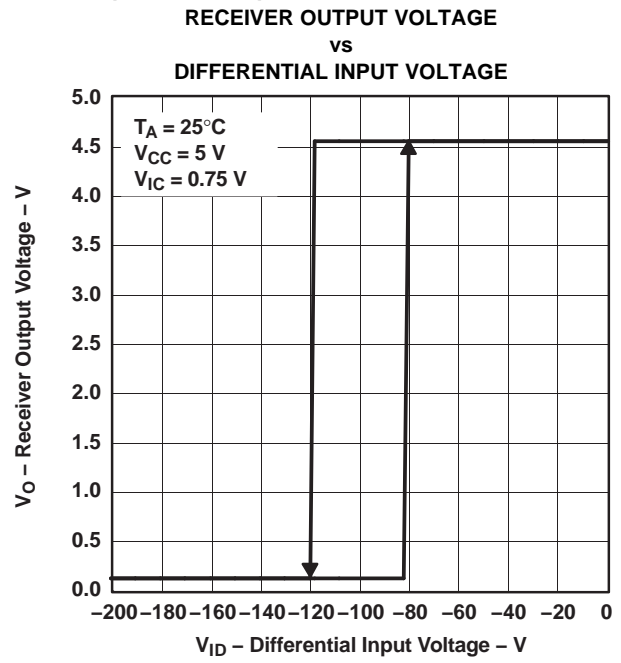
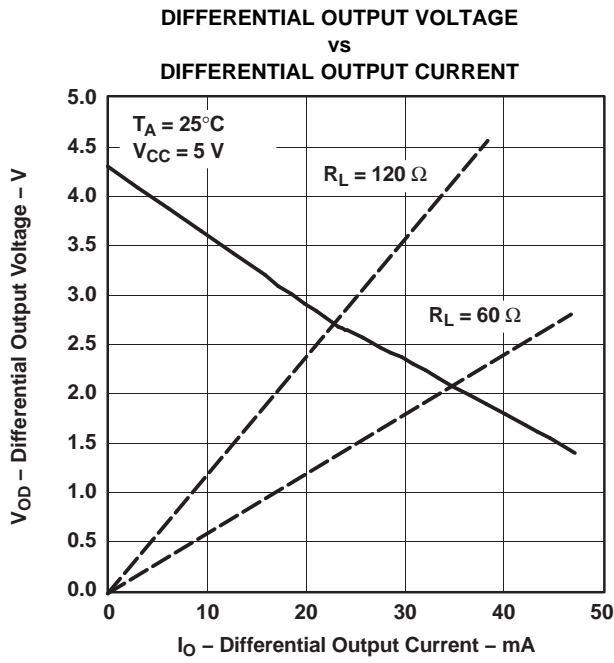

Figure 15.

TYPICAL CHARACTERISTICS (continued)



APPLICATION INFORMATION

Hot-Plugging

These devices are designed to operate in “hot swap” or “hot pluggable” applications. Key features for hot-pluggable applications are power-up, power-down glitch free operation, default disabled input/output pins, and receiver failsafe. An internal Power-On Reset circuit keeps the outputs in a high-impedance state until the supply voltage has reached a level at which the device will reliably operate. This ensures that no spurious transitions (glitches) will occur on the bus pin outputs as the power supply turns on or turns off.

As shown in the device FUNCTION TABLES, the ENABLE inputs have the feature of default disable on both the driver enable and receiver enable. This ensures that the device will neither drive the bus nor report data on the R pin until the associated controller actively drives the enable pins.

REVISION HISTORY

Changes from Revision B (March 2007) to Revision C Page

• Added D package	1
• Added D package and information to Ordering Information	2
• Added D package information to Power Dissipation Ratings	2
• Changed Electrostatic Discharge Protection	2
• Changed Supply Current information	3
• Changed Receiver Switching Characteristics	5
• Changed Figure 5	7
• Changed Figure 6	7

Changes from Revision C (December 2009) to Revision D Page

• Added Differential input voltage dynamic to RECOMMENDED OPERATING CONDITIONS	3
• Added Figure 11	9

Changes from Revision D (January 2011) to Revision E Page

• Added Power-Up, Power-Down Glitch-Free Operation to FEATURES	1
• Changed ENABLE in DRIVER FUNCTION TABLE from L to L or OPEN	9
• Changed ENABLE in RECEIVER FUNCTION TABLE from H to H or OPEN	9
• Added APPLICATION INFORMATION section	13

PACKAGING INFORMATION

Orderable Device	Status (1)	Package Type	Package Drawing	Pins	Package Qty	Eco Plan (2)	Lead/Ball Finish (6)	MSL Peak Temp (3)	Op Temp (°C)	Device Marking (4/5)	Samples
SN65HVD3080EDGS	ACTIVE	VSSOP	DGS	10	80	Green (RoHS & no Sb/Br)	CU NIPDAU Call TI	Level-2-260C-1 YEAR	-40 to 85	BTT	Samples
SN65HVD3080EDGSG4	ACTIVE	VSSOP	DGS	10	80	Green (RoHS & no Sb/Br)	Call TI	Level-2-260C-1 YEAR	-40 to 85	BTT	Samples
SN65HVD3080EDGSR	ACTIVE	VSSOP	DGS	10	2500	Green (RoHS & no Sb/Br)	CU NIPDAU	Level-2-260C-1 YEAR	-40 to 85	BTT	Samples
SN65HVD3083EDGS	ACTIVE	VSSOP	DGS	10	80	Green (RoHS & no Sb/Br)	CU NIPDAU	Level-2-260C-1 YEAR	-40 to 85	BTU	Samples
SN65HVD3083EDGSR	ACTIVE	VSSOP	DGS	10	2500	Green (RoHS & no Sb/Br)	CU NIPDAU Call TI	Level-2-260C-1 YEAR	-40 to 85	BTU	Samples
SN65HVD3086ED	ACTIVE	SOIC	D	14	50	Green (RoHS & no Sb/Br)	CU NIPDAU	Level-1-260C-UNLIM	-40 to 85	HVD3086E	Samples
SN65HVD3086EDGS	ACTIVE	VSSOP	DGS	10	80	Green (RoHS & no Sb/Br)	CU NIPDAU Call TI	Level-2-260C-1 YEAR	-40 to 85	BTF	Samples
SN65HVD3086EDGSR	ACTIVE	VSSOP	DGS	10	2500	Green (RoHS & no Sb/Br)	CU NIPDAU	Level-2-260C-1 YEAR	-40 to 85	BTF	Samples
SN65HVD3086EDR	ACTIVE	SOIC	D	14	2500	Green (RoHS & no Sb/Br)	CU NIPDAU	Level-1-260C-UNLIM	-40 to 85	HVD3086E	Samples

(1) The marketing status values are defined as follows:

ACTIVE: Product device recommended for new designs.

LIFEBUY: TI has announced that the device will be discontinued, and a lifetime-buy period is in effect.

NRND: Not recommended for new designs. Device is in production to support existing customers, but TI does not recommend using this part in a new design.

PREVIEW: Device has been announced but is not in production. Samples may or may not be available.

OBSOLETE: TI has discontinued the production of the device.

(2) **RoHS:** TI defines "RoHS" to mean semiconductor products that are compliant with the current EU RoHS requirements for all 10 RoHS substances, including the requirement that RoHS substance do not exceed 0.1% by weight in homogeneous materials. Where designed to be soldered at high temperatures, "RoHS" products are suitable for use in specified lead-free processes. TI may reference these types of products as "Pb-Free".

RoHS Exempt: TI defines "RoHS Exempt" to mean products that contain lead but are compliant with EU RoHS pursuant to a specific EU RoHS exemption.

Green: TI defines "Green" to mean the content of Chlorine (Cl) and Bromine (Br) based flame retardants meet JS709B low halogen requirements of <=1000ppm threshold. Antimony trioxide based flame retardants must also meet the <=1000ppm threshold requirement.

(3) MSL, Peak Temp. - The Moisture Sensitivity Level rating according to the JEDEC industry standard classifications, and peak solder temperature.

(4) There may be additional marking, which relates to the logo, the lot trace code information, or the environmental category on the device.

(5) Multiple Device Markings will be inside parentheses. Only one Device Marking contained in parentheses and separated by a "~" will appear on a device. If a line is indented then it is a continuation of the previous line and the two combined represent the entire Device Marking for that device.

(6) Lead/Ball Finish - Orderable Devices may have multiple material finish options. Finish options are separated by a vertical ruled line. Lead/Ball Finish values may wrap to two lines if the finish value exceeds the maximum column width.

Important Information and Disclaimer:The information provided on this page represents TI's knowledge and belief as of the date that it is provided. TI bases its knowledge and belief on information provided by third parties, and makes no representation or warranty as to the accuracy of such information. Efforts are underway to better integrate information from third parties. TI has taken and continues to take reasonable steps to provide representative and accurate information but may not have conducted destructive testing or chemical analysis on incoming materials and chemicals. TI and TI suppliers consider certain information to be proprietary, and thus CAS numbers and other limited information may not be available for release.

In no event shall TI's liability arising out of such information exceed the total purchase price of the TI part(s) at issue in this document sold by TI to Customer on an annual basis.

TAPE AND REEL INFORMATION

QUADRANT ASSIGNMENTS FOR PIN 1 ORIENTATION IN TAPE

*All dimensions are nominal

Device	Package Type	Package Drawing	Pins	SPQ	Reel Diameter (mm)	Reel Width W1 (mm)	A0 (mm)	B0 (mm)	K0 (mm)	P1 (mm)	W (mm)	Pin1 Quadrant
SN65HVD3080EDGSR	VSSOP	DGS	10	2500	330.0	12.4	5.3	3.4	1.4	8.0	12.0	Q1
SN65HVD3083EDGSR	VSSOP	DGS	10	2500	330.0	12.4	5.3	3.4	1.4	8.0	12.0	Q1
SN65HVD3086EDGSR	VSSOP	DGS	10	2500	330.0	12.4	5.3	3.4	1.4	8.0	12.0	Q1
SN65HVD3086EDR	SOIC	D	14	2500	330.0	16.4	6.5	9.0	2.1	8.0	16.0	Q1

TAPE AND REEL BOX DIMENSIONS

*All dimensions are nominal

Device	Package Type	Package Drawing	Pins	SPQ	Length (mm)	Width (mm)	Height (mm)
SN65HVD3080EDGSR	VSSOP	DGS	10	2500	367.0	367.0	35.0
SN65HVD3083EDGSR	VSSOP	DGS	10	2500	367.0	367.0	35.0
SN65HVD3086EDGSR	VSSOP	DGS	10	2500	367.0	367.0	35.0
SN65HVD3086EDR	SOIC	D	14	2500	367.0	367.0	38.0

DGS0010A



PACKAGE OUTLINE

VSSOP - 1.1 mm max height

SMALL OUTLINE PACKAGE

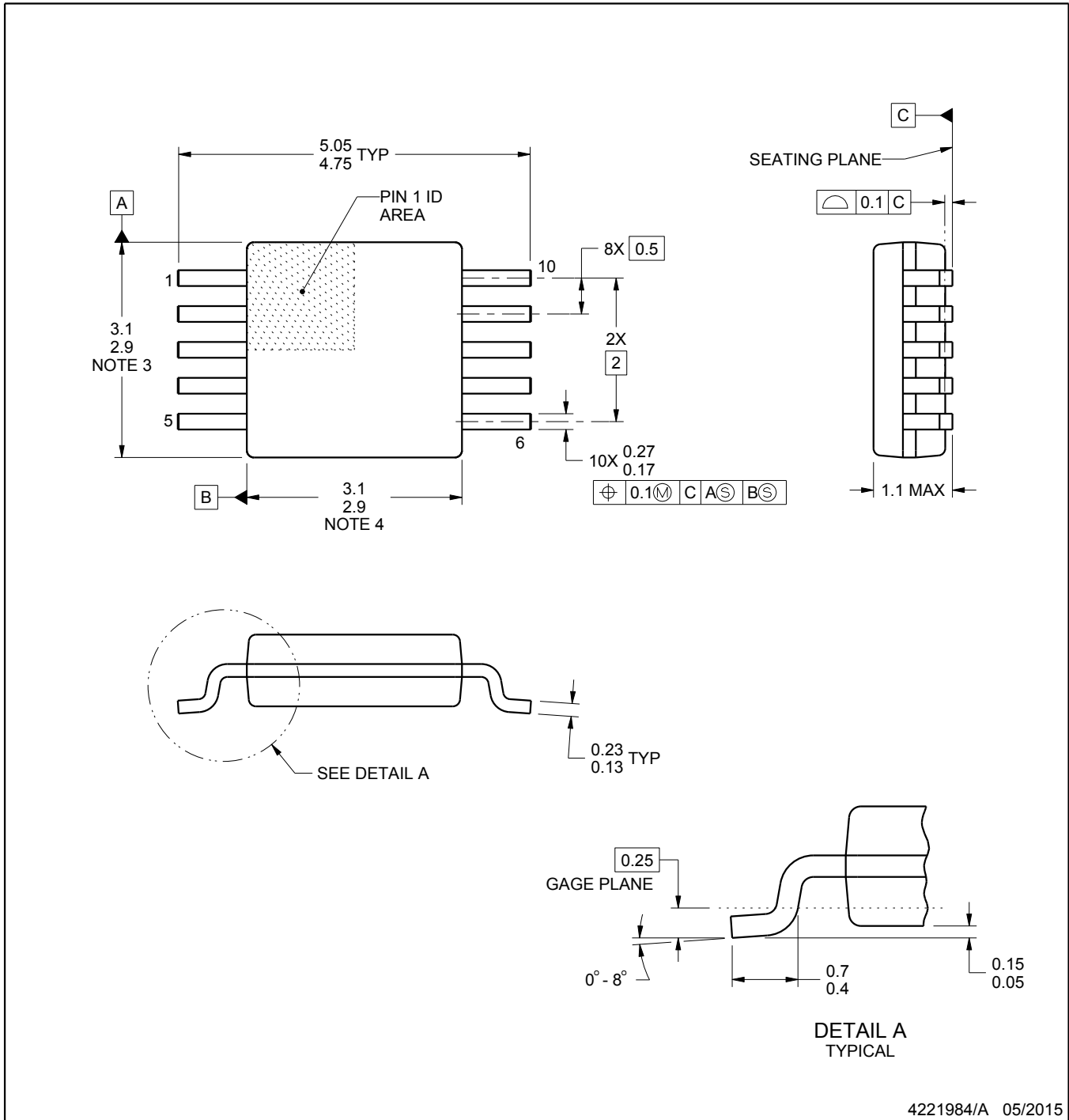

4221984/A 05/2015

NOTES:

1. All linear dimensions are in millimeters. Any dimensions in parenthesis are for reference only. Dimensioning and tolerancing per ASME Y14.5M.
2. This drawing is subject to change without notice.
3. This dimension does not include mold flash, protrusions, or gate burrs. Mold flash, protrusions, or gate burrs shall not exceed 0.15 mm per side.
4. This dimension does not include interlead flash. Interlead flash shall not exceed 0.25 mm per side.
5. Reference JEDEC registration MO-187, variation BA.

EXAMPLE BOARD LAYOUT

DGS0010A

VSSOP - 1.1 mm max height

SMALL OUTLINE PACKAGE



LAND PATTERN EXAMPLE
SCALE:10X

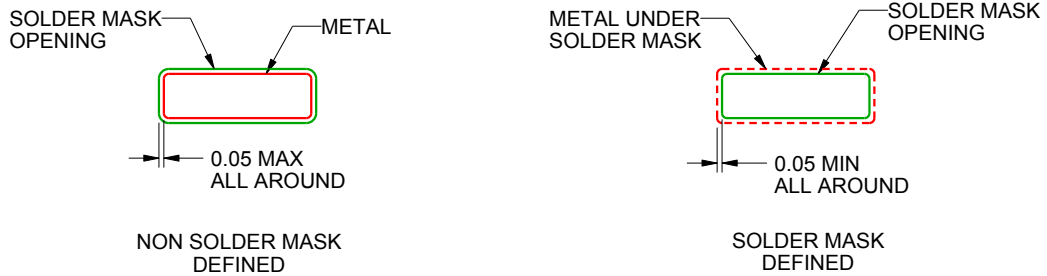

SOLDER MASK DETAILS
NOT TO SCALE

4221984/A 05/2015

NOTES: (continued)

- 6. Publication IPC-7351 may have alternate designs.
- 7. Solder mask tolerances between and around signal pads can vary based on board fabrication site.

EXAMPLE STENCIL DESIGN

DGS0010A

VSSOP - 1.1 mm max height

SMALL OUTLINE PACKAGE



SOLDER PASTE EXAMPLE
BASED ON 0.125 mm THICK STENCIL
SCALE:10X

4221984/A 05/2015

NOTES: (continued)

8. Laser cutting apertures with trapezoidal walls and rounded corners may offer better paste release. IPC-7525 may have alternate design recommendations.
9. Board assembly site may have different recommendations for stencil design.

D (R-PDSO-G14)

PLASTIC SMALL OUTLINE



- NOTES:
- All linear dimensions are in millimeters.
 - This drawing is subject to change without notice.
 - Publication IPC-7351 is recommended for alternate designs.
 - Laser cutting apertures with trapezoidal walls and also rounding corners will offer better paste release. Customers should contact their board assembly site for stencil design recommendations. Refer to IPC-7525 for other stencil recommendations.
 - Customers should contact their board fabrication site for solder mask tolerances between and around signal pads.

IMPORTANT NOTICE AND DISCLAIMER

TI PROVIDES TECHNICAL AND RELIABILITY DATA (INCLUDING DATASHEETS), DESIGN RESOURCES (INCLUDING REFERENCE DESIGNS), APPLICATION OR OTHER DESIGN ADVICE, WEB TOOLS, SAFETY INFORMATION, AND OTHER RESOURCES "AS IS" AND WITH ALL FAULTS, AND DISCLAIMS ALL WARRANTIES, EXPRESS AND IMPLIED, INCLUDING WITHOUT LIMITATION ANY IMPLIED WARRANTIES OF MERCHANTABILITY, FITNESS FOR A PARTICULAR PURPOSE OR NON-INFRINGEMENT OF THIRD PARTY INTELLECTUAL PROPERTY RIGHTS.

These resources are intended for skilled developers designing with TI products. You are solely responsible for (1) selecting the appropriate TI products for your application, (2) designing, validating and testing your application, and (3) ensuring your application meets applicable standards, and any other safety, security, or other requirements. These resources are subject to change without notice. TI grants you permission to use these resources only for development of an application that uses the TI products described in the resource. Other reproduction and display of these resources is prohibited. No license is granted to any other TI intellectual property right or to any third party intellectual property right. TI disclaims responsibility for, and you will fully indemnify TI and its representatives against, any claims, damages, costs, losses, and liabilities arising out of your use of these resources.

TI's products are provided subject to TI's Terms of Sale (www.ti.com/legal/termsofsale.html) or other applicable terms available either on ti.com or provided in conjunction with such TI products. TI's provision of these resources does not expand or otherwise alter TI's applicable warranties or warranty disclaimers for TI products.

Mailing Address: Texas Instruments, Post Office Box 655303, Dallas, Texas 75265
Copyright © 2019, Texas Instruments Incorporated