

# NTD2955, NVD2955

## Power MOSFET

-60 V, -12 A, P-Channel DPAK

This Power MOSFET is designed to withstand high energy in the avalanche and commutation modes. Designed for low-voltage, high-speed switching applications in power supplies, converters, and power motor controls. These devices are particularly well suited for bridge circuits where diode speed and commutating safe operating areas are critical and offer an additional safety margin against unexpected voltage transients.

### Features

- Avalanche Energy Specified
- $I_{DSS}$  and  $V_{DS(on)}$  Specified at Elevated Temperature
- Designed for Low-Voltage, High-Speed Switching Applications and to Withstand High Energy in the Avalanche and Commutation Modes
- NVD and SVD Prefix for Automotive and Other Applications Requiring Unique Site and Control Change Requirements; AEC-Q101 Qualified and PPAP Capable
- These Devices are Pb-Free and are RoHS Compliant

### MAXIMUM RATINGS ( $T_J = 25^\circ\text{C}$ unless otherwise noted)

| Rating  | Symbol          | Value      | Unit               |
|---|-----------------|------------|--------------------|
| Drain-to-Source Voltage   | $V_{DSS}$       | -60        | Vdc                |
| Gate-to-Source Voltage  | $V_{GS}$        | $\pm 20$   | Vdc                |
| - Continuous  | $V_{GSM}$       | $\pm 25$   | Vpk                |
| - Non-repetitive ( $t_p \leq 10$ ms)  |                 |            |                    |
| Drain Current   | $I_D$           | -12        | Adc                |
| - Continuous @ $T_a = 25^\circ\text{C}$   | $I_{DM}$        | -18        | Apk                |
| - Single Pulse ( $t_p \leq 10$ ms)  |                 |            |                    |
| Total Power Dissipation @ $T_a = 25^\circ\text{C}$  | $P_D$           | 55         | W                  |
| Operating and Storage Temperature Range   | $T_J, T_{stg}$  | -55 to 175 | $^\circ\text{C}$   |
| Single Pulse Drain-to-Source Avalanche Energy - Starting $T_J = 25^\circ\text{C}$<br>( $V_{DD} = 25$ Vdc, $V_{GS} = 10$ Vdc, Peak $I_L = 12$ Apk, $L = 3.0$ mH, $R_G = 25$ $\Omega$ ) | $E_{AS}$        | 216        | mJ                 |
| Thermal Resistance  | $R_{\theta JC}$ | 2.73       | $^\circ\text{C/W}$ |
| - Junction-to-Case  | $R_{\theta JA}$ | 71.4       |                    |
| - Junction-to-Ambient (Note 1)  | $R_{\theta JA}$ | 100        |                    |
| - Junction-to-Ambient (Note 2)  |                 |            |                    |
| Maximum Lead Temperature for Soldering Purposes, 1/8 in. from case for 10 seconds   | $T_L$           | 260        | $^\circ\text{C}$   |

Stresses exceeding those listed in the Maximum Ratings table may damage the device. If any of these limits are exceeded, device functionality should not be assumed, damage may occur and reliability may be affected.

1. When surface mounted to an FR4 board using 1 in pad size (Cu area = 1.127 in<sup>2</sup>).
2. When surface mounted to an FR4 board using the minimum recommended pad size (Cu area = 0.412 in<sup>2</sup>).



ON Semiconductor®

[www.onsemi.com](http://www.onsemi.com)

| $V_{(BR)DSS}$ | $R_{DS(on)}$ TYP            | $I_D$ MAX |
|---------------|-----------------------------|-----------|
| -60 V         | 155 m $\Omega$ @ -10 V, 6 A | -12 A     |

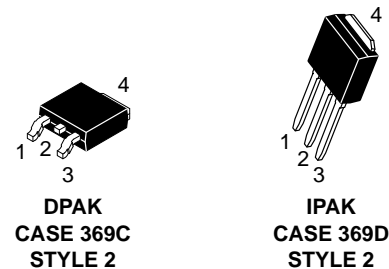
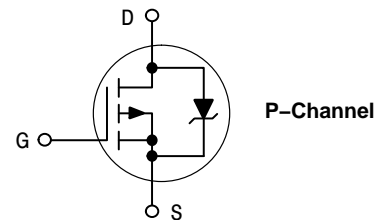

### MARKING DIAGRAMS & PIN ASSIGNMENTS

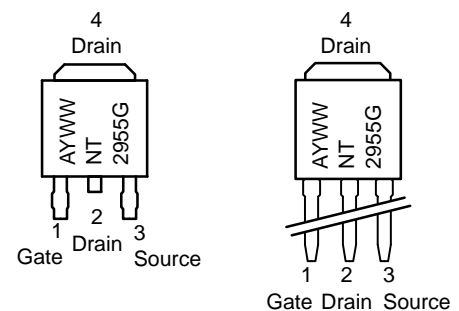

A = Assembly Location\*  
 NT2955/NV2955 = Specific Device Code (DPAK)  
 NT2955 = Specific Device Code (IPAK)  
 Y = Year  
 WW = Work Week  
 G = Pb-Free Package

\* The Assembly Location code (A) is front side optional. In cases where the Assembly Location is stamped in the package, the front side assembly code may be blank.

### ORDERING INFORMATION

See detailed ordering and shipping information on page 5 of this data sheet.

# NTD2955, NVD2955

## ELECTRICAL CHARACTERISTICS ( $T_J = 25^\circ\text{C}$ unless otherwise noted)

| Characteristic | Symbol | Min | Typ | Max | Unit |
|----------------|--------|-----|-----|-----|------|
|----------------|--------|-----|-----|-----|------|

### OFF CHARACTERISTICS

|  |               |          |   |             |                             |
|--|---------------|----------|---|-------------|-----------------------------|
| Drain-to-Source Breakdown Voltage (Note 3)<br>( $V_{GS} = 0\text{ Vdc}$ , $I_D = -0.25\text{ mA}$ )<br>(Positive Temperature Coefficient)  | $V_{(BR)DSS}$ | -60<br>- | - | -           | Vdc<br>mV/ $^\circ\text{C}$ |
| Zero Gate Voltage Drain Current<br>( $V_{GS} = 0\text{ Vdc}$ , $V_{DS} = -60\text{ Vdc}$ , $T_J = 25^\circ\text{C}$ )<br>( $V_{GS} = 0\text{ Vdc}$ , $V_{DS} = -60\text{ Vdc}$ , $T_J = 150^\circ\text{C}$ ) | $I_{DSS}$     | -        | - | -10<br>-100 | $\mu\text{Adc}$             |
| Gate-Body Leakage Current ( $V_{GS} = \pm 20\text{ Vdc}$ , $V_{DS} = 0\text{ Vdc}$ )   | $I_{GSS}$     | -        | - | -100        | nAdc                        |

### ON CHARACTERISTICS (Note 3)

|   |              |           |             |              |                             |
|---|--------------|-----------|-------------|--------------|-----------------------------|
| Gate Threshold Voltage<br>( $V_{DS} = V_{GS}$ , $I_D = -250\ \mu\text{Adc}$ )<br>(Negative Temperature Coefficient)   | $V_{GS(th)}$ | -2.0<br>- | -2.8<br>4.5 | -4.0<br>-    | Vdc<br>mV/ $^\circ\text{C}$ |
| Static Drain-Source On-State Resistance<br>( $V_{GS} = -10\text{ Vdc}$ , $I_D = -6.0\text{ Adc}$ )  | $R_{DS(on)}$ | -         | 0.155       | 0.180        | $\Omega$                    |
| Drain-to-Source On-Voltage<br>( $V_{GS} = -10\text{ Vdc}$ , $I_D = -12\text{ Adc}$ )<br>( $V_{GS} = -10\text{ Vdc}$ , $I_D = -6.0\text{ Adc}$ , $T_J = 150^\circ\text{C}$ ) | $V_{DS(on)}$ | -         | -1.86<br>-  | -2.6<br>-2.0 | Vdc                         |
| Forward Transconductance ( $V_{DS} = 10\text{ Vdc}$ , $I_D = 6.0\text{ Adc}$ )  | gFS          | -         | 8.0         | -            | Mhos                        |

### DYNAMIC CHARACTERISTICS

|                              |  |           |   |     |     |    |
|------------------------------|--|-----------|---|-----|-----|----|
| Input Capacitance            | $(V_{DS} = -25\text{ Vdc}$ , $V_{GS} = 0\text{ Vdc}$ ,<br>$F = 1.0\text{ MHz}$ ) | $C_{iss}$ | - | 500 | 750 | pF |
| Output Capacitance           |  | $C_{oss}$ | - | 150 | 250 |    |
| Reverse Transfer Capacitance |  | $C_{rss}$ | - | 50  | 100 |    |

### SWITCHING CHARACTERISTICS (Notes 3 and 4)

|                     |  |              |   |     |    |    |
|---------------------|--|--------------|---|-----|----|----|
| Turn-On Delay Time  | $(V_{DD} = -30\text{ Vdc}$ , $I_D = -12\text{ A}$ ,<br>$V_{GS} = -10\text{ V}$ , $R_G = 9.1\ \Omega$ ) | $t_{d(on)}$  | - | 10  | 20 | ns |
| Rise Time           |  | $t_r$        | - | 45  | 85 |    |
| Turn-Off Delay Time |  | $t_{d(off)}$ | - | 26  | 40 |    |
| Fall Time           |  | $t_f$        | - | 48  | 90 |    |
| Gate Charge         | $(V_{DS} = -48\text{ Vdc}$ , $V_{GS} = -10\text{ Vdc}$ ,<br>$I_D = -12\text{ A}$ )                     | $Q_T$        | - | 15  | 30 | nC |
|                     |  | $Q_{GS}$     | - | 4.0 | -  |    |
|                     |  | $Q_{GD}$     | - | 7.0 | -  |    |

### DRAIN-SOURCE DIODE CHARACTERISTICS (Note 3)

|  |          |   |              |           |               |
|--|----------|---|--------------|-----------|---------------|
| Diode Forward On-Voltage<br>( $I_S = 12\text{ Adc}$ , $V_{GS} = 0\text{ V}$ )<br>( $I_S = 12\text{ Adc}$ , $V_{GS} = 0\text{ V}$ , $T_J = 150^\circ\text{C}$ ) | $V_{SD}$ | - | -1.6<br>-1.3 | -2.5<br>- | Vdc           |
| Reverse Recovery Time<br>( $I_S = 12\text{ A}$ , $di_S/dt = 100\text{ A}/\mu\text{s}$ , $V_{GS} = 0\text{ V}$ )  | $t_{rr}$ | - | 50           | -         | ns            |
|  | $t_a$    | - | 40           | -         |               |
|  | $t_b$    | - | 10           | -         |               |
| Reverse Recovery Stored Charge   | $Q_{RR}$ | - | 0.10         | -         | $\mu\text{C}$ |

Product parametric performance is indicated in the Electrical Characteristics for the listed test conditions, unless otherwise noted. Product performance may not be indicated by the Electrical Characteristics if operated under different conditions.

3. Indicates Pulse Test: Pulse Width  $\leq 300\ \mu\text{s}$ , Duty Cycle  $\leq 2\%$ .

4. Switching characteristics are independent of operating junction temperature.

# NTD2955, NVD2955

## TYPICAL PERFORMANCE CURVES ( $T_J = 25^\circ\text{C}$ unless otherwise noted)

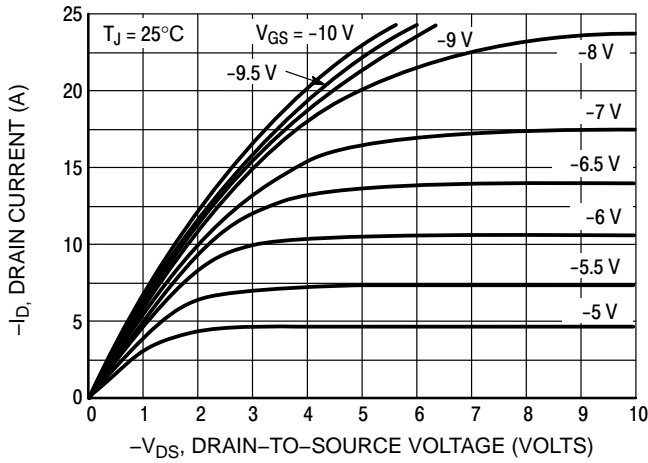

Figure 1. On-Region Characteristics

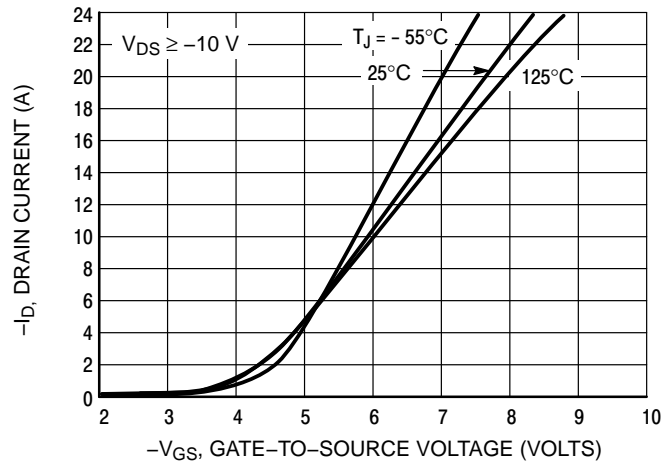

Figure 2. Transfer Characteristics

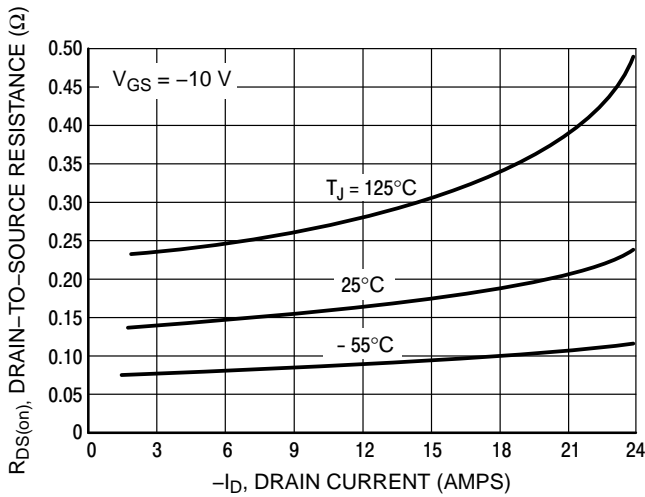

Figure 3. On-Resistance versus Drain Current and Temperature

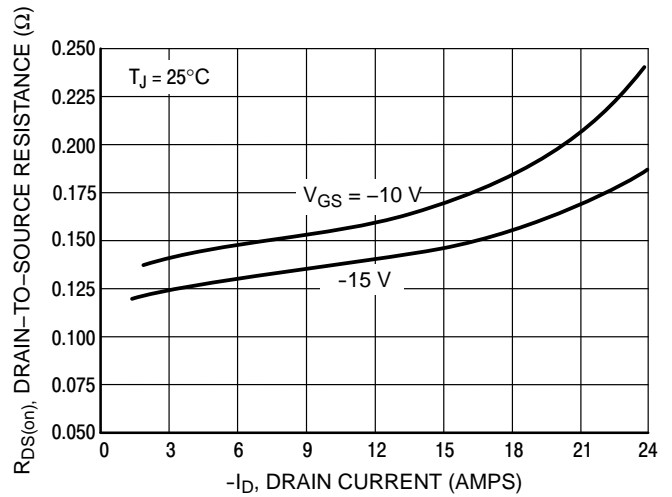

Figure 4. On-Resistance versus Drain Current and Gate Voltage

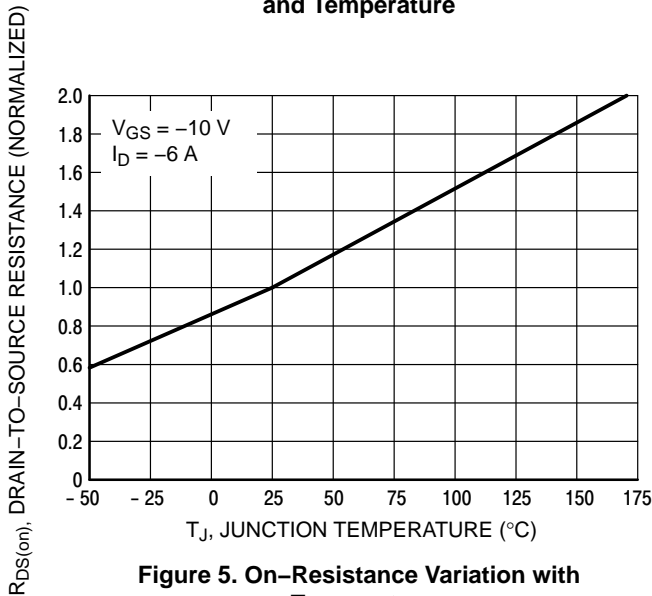

Figure 5. On-Resistance Variation with Temperature

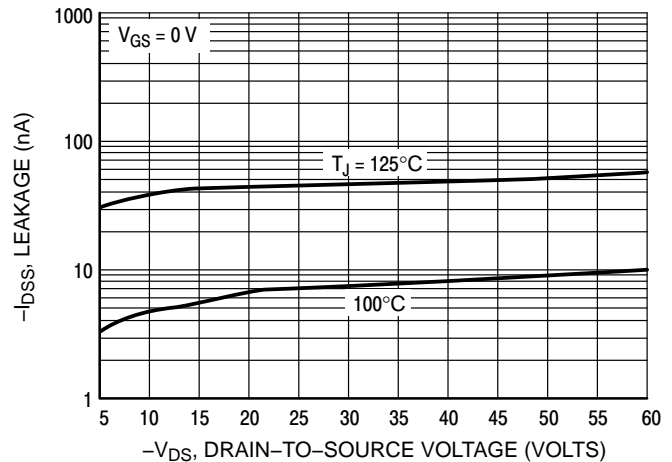

Figure 6. Drain-To-Source Leakage Current versus Voltage

# NTD2955, NVD2955

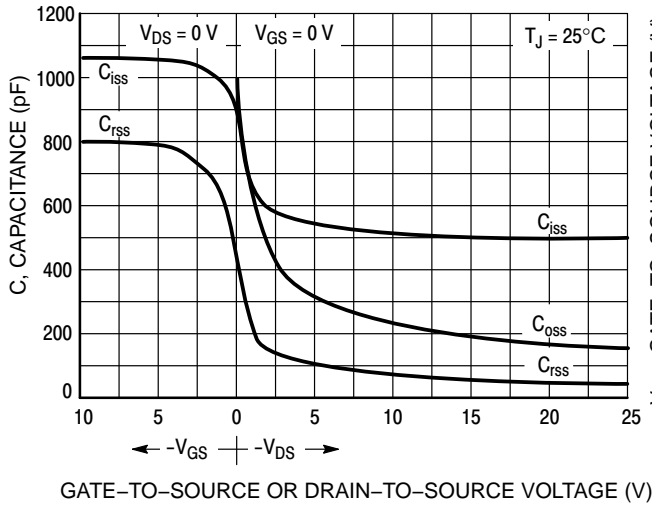

Figure 7. Capacitance Variation

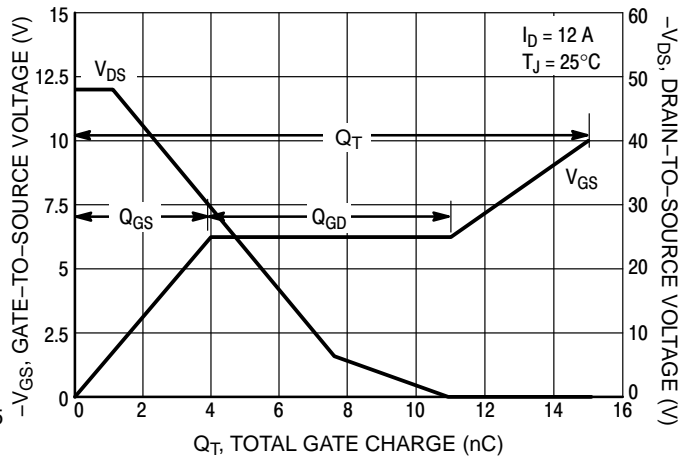

Figure 8. Gate-To-Source and Drain-To-Source Voltage versus Total Charge

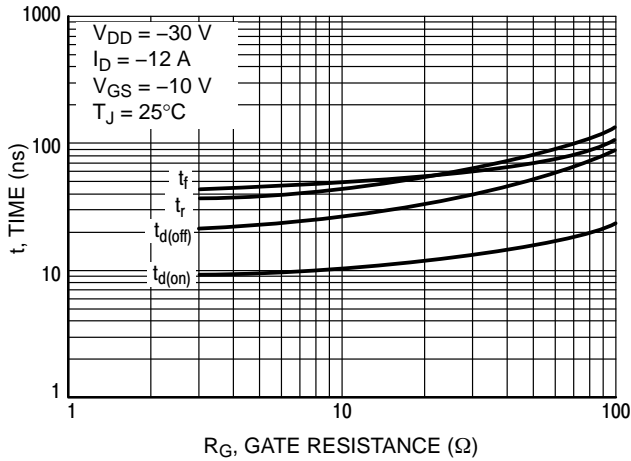

Figure 9. Resistive Switching Time Variation versus Gate Resistance

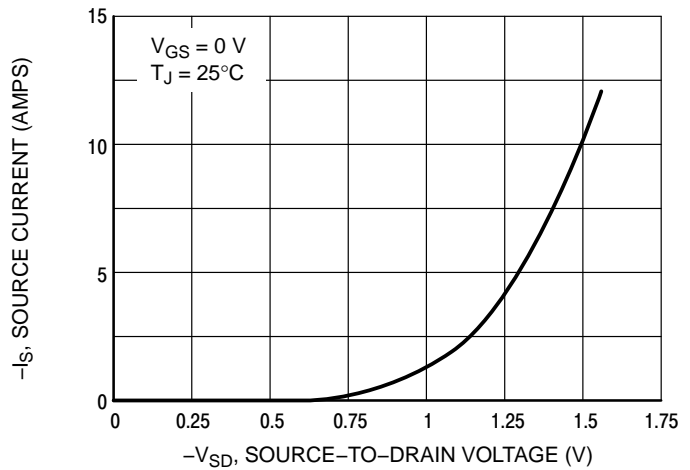

Figure 10. Diode Forward Voltage versus Current

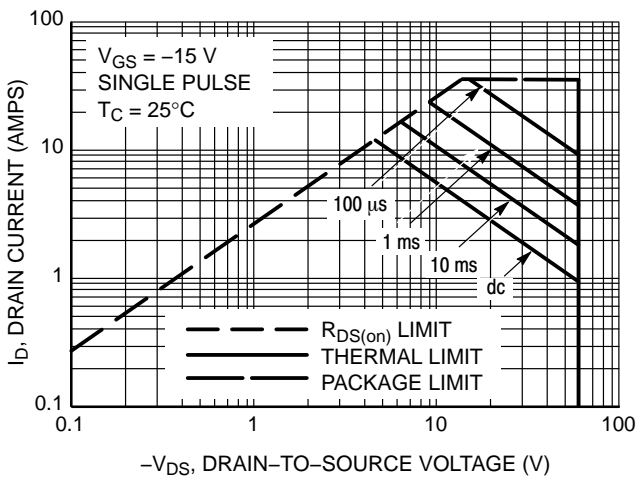

Figure 11. Maximum Rated Forward Biased Safe Operating Area

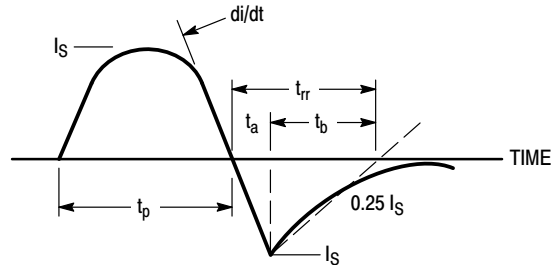
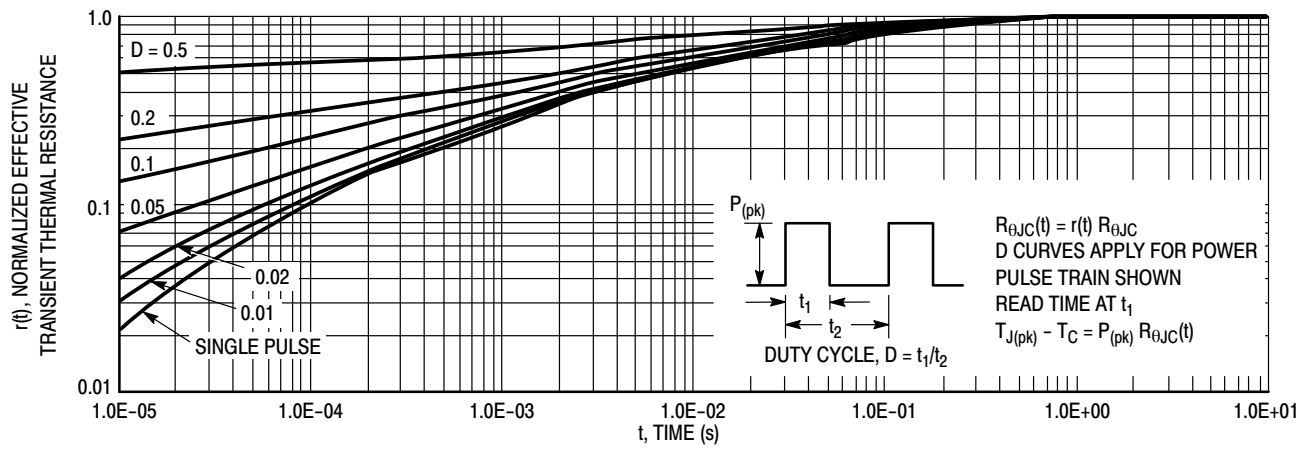

Figure 12. Diode Reverse Recovery Waveform

## NTD2955, NVD2955



**Figure 13. Thermal Response**

### ORDERING INFORMATION

| Device      | Package           | Shipping <sup>†</sup> |
|-------------|-------------------|-----------------------|
| NTD2955G    | DPAK<br>(Pb-Free) | 75 Units / Rail       |
| NTD2955-1G  | IPAK<br>(Pb-Free) | 75 Units / Rail       |
| NTD2955T4G  | DPAK<br>(Pb-Free) | 2500 / Tape & Reel    |
| NVD2955T4G* | DPAK<br>(Pb-Free) | 2500 / Tape & Reel    |
| SVD2955T4G* | DPAK<br>(Pb-Free) | 2500 / Tape & Reel    |

<sup>†</sup>For information on tape and reel specifications, including part orientation and tape sizes, please refer to our Tape and Reel Packaging Specifications Brochure, BRD8011/D.

\*NVD and SVD Prefix for Automotive and Other Applications Requiring Unique Site and Control Change Requirements; AEC-Q101 Qualified and PPAP Capable.

# NTD2955, NVD2955

## PACKAGE DIMENSIONS

### DPAK (SINGLE GAUGE) CASE 369C ISSUE F

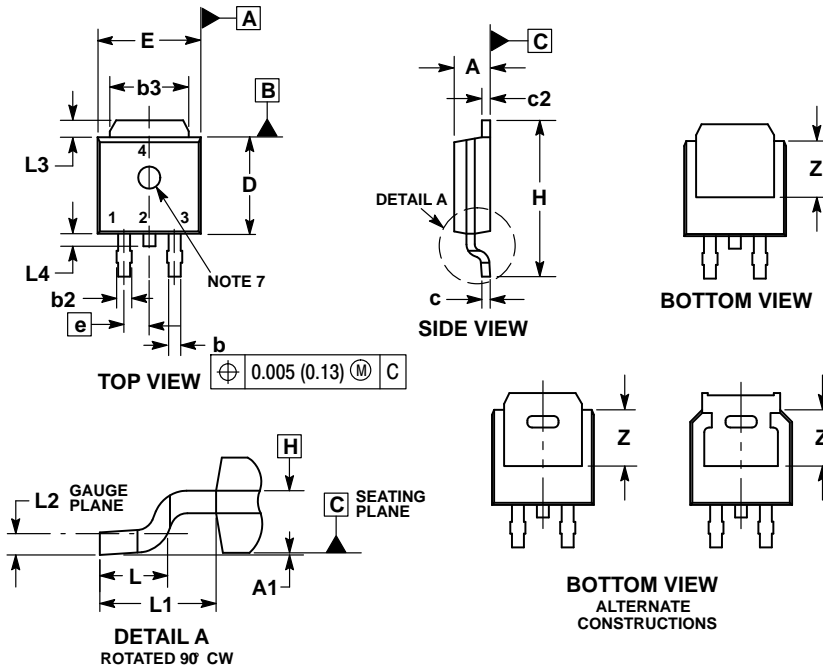

**NOTES:**

1. DIMENSIONING AND TOLERANCING PER ASME Y14.5M, 1994.
2. CONTROLLING DIMENSION: INCHES.
3. THERMAL PAD CONTOUR OPTIONAL WITHIN DIMENSIONS b3, L3 and Z.
4. DIMENSIONS D AND E DO NOT INCLUDE MOLD FLASH, PROTRUSIONS, OR BURRS. MOLD FLASH, PROTRUSIONS, OR GATE BURRS SHALL NOT EXCEED 0.006 INCHES PER SIDE.
5. DIMENSIONS D AND E ARE DETERMINED AT THE OUTERMOST EXTREMES OF THE PLASTIC BODY.
6. DATUMS A AND B ARE DETERMINED AT DATUM PLANE H.
7. OPTIONAL MOLD FEATURE.

| DIM | INCHES |       | MILLIMETERS |       |
|-----|--------|-------|-------------|-------|
|     | MIN    | MAX   | MIN         | MAX   |
| A   | 0.086  | 0.094 | 2.18        | 2.38  |
| A1  | 0.000  | 0.005 | 0.00        | 0.13  |
| b   | 0.025  | 0.035 | 0.63        | 0.89  |
| b2  | 0.028  | 0.045 | 0.72        | 1.14  |
| b3  | 0.180  | 0.215 | 4.57        | 5.46  |
| c   | 0.018  | 0.024 | 0.46        | 0.61  |
| c2  | 0.018  | 0.024 | 0.46        | 0.61  |
| D   | 0.235  | 0.245 | 5.97        | 6.22  |
| E   | 0.250  | 0.265 | 6.35        | 6.73  |
| e   | 0.090  | BSC   | 2.29        | BSC   |
| H   | 0.370  | 0.410 | 9.40        | 10.41 |
| L   | 0.055  | 0.070 | 1.40        | 1.78  |
| L1  | 0.114  | REF   | 2.90        | REF   |
| L2  | 0.020  | BSC   | 0.51        | BSC   |
| L3  | 0.035  | 0.050 | 0.89        | 1.27  |
| L4  | ---    | 0.040 | ---         | 1.01  |
| Z   | 0.155  | ---   | 3.93        | ---   |

**STYLE 2:**

1. GATE
2. DRAIN
3. SOURCE
4. DRAIN

### SOLDERING FOOTPRINT\*

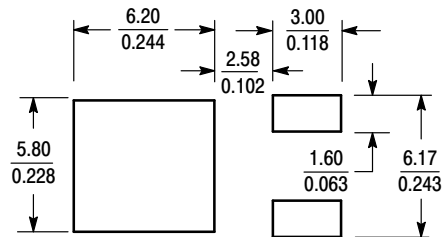

SCALE 3:1  $\left(\frac{\text{mm}}{\text{inches}}\right)$

\*For additional information on our Pb-Free strategy and soldering details, please download the ON Semiconductor Soldering and Mounting Techniques Reference Manual, SOLDERRM/D.

# NTD2955, NVD2955

## PACKAGE DIMENSIONS

### IPAK CASE 369D ISSUE C

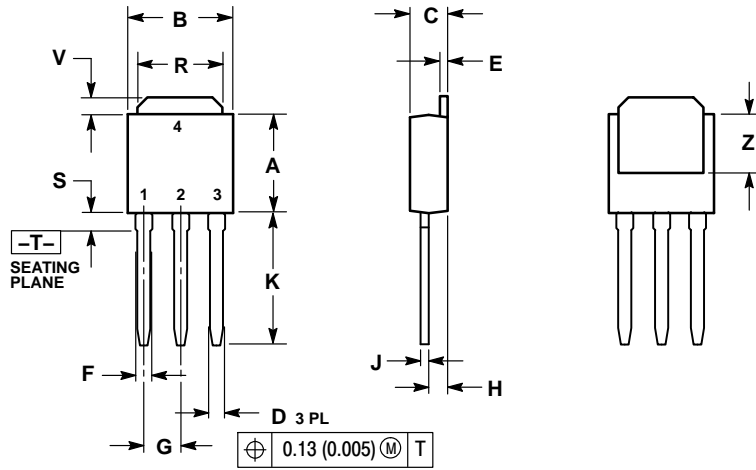

**NOTES:**

1. DIMENSIONING AND TOLERANCING PER ANSI Y14.5M, 1982.
2. CONTROLLING DIMENSION: INCH.

| DIM | INCHES |       | MILLIMETERS |      |
|-----|--------|-------|-------------|------|
|     | MIN    | MAX   | MIN         | MAX  |
| A   | 0.235  | 0.245 | 5.97        | 6.35 |
| B   | 0.250  | 0.265 | 6.35        | 6.73 |
| C   | 0.086  | 0.094 | 2.19        | 2.38 |
| D   | 0.027  | 0.035 | 0.69        | 0.88 |
| E   | 0.018  | 0.023 | 0.46        | 0.58 |
| F   | 0.037  | 0.045 | 0.94        | 1.14 |
| G   | 0.090  | BSC   | 2.29        | BSC  |
| H   | 0.034  | 0.040 | 0.87        | 1.01 |
| J   | 0.018  | 0.023 | 0.46        | 0.58 |
| K   | 0.350  | 0.380 | 8.89        | 9.65 |
| R   | 0.180  | 0.215 | 4.45        | 5.45 |
| S   | 0.025  | 0.040 | 0.63        | 1.01 |
| V   | 0.035  | 0.050 | 0.89        | 1.27 |
| Z   | 0.155  | ---   | 3.93        | ---  |

**STYLE 2:**

- PIN 1. GATE
- 2. DRAIN
- 3. SOURCE
- 4. DRAIN

ON Semiconductor and are trademarks of Semiconductor Components Industries, LLC dba ON Semiconductor or its subsidiaries in the United States and/or other countries. ON Semiconductor owns the rights to a number of patents, trademarks, copyrights, trade secrets, and other intellectual property. A listing of ON Semiconductor's product/patent coverage may be accessed at [www.onsemi.com/site/pdf/Patent-Marking.pdf](http://www.onsemi.com/site/pdf/Patent-Marking.pdf). ON Semiconductor reserves the right to make changes without further notice to any products herein. ON Semiconductor makes no warranty, representation or guarantee regarding the suitability of its products for any particular purpose, nor does ON Semiconductor assume any liability arising out of the application or use of any product or circuit, and specifically disclaims any and all liability, including without limitation special, consequential or incidental damages. Buyer is responsible for its products and applications using ON Semiconductor products, including compliance with all laws, regulations and safety requirements or standards, regardless of any support or applications information provided by ON Semiconductor. "Typical" parameters which may be provided in ON Semiconductor data sheets and/or specifications can and do vary in different applications and actual performance may vary over time. All operating parameters, including "Typicals" must be validated for each customer application by customer's technical experts. ON Semiconductor does not convey any license under its patent rights nor the rights of others. ON Semiconductor products are not designed, intended, or authorized for use as a critical component in life support systems or any FDA Class 3 medical devices or medical devices with a same or similar classification in a foreign jurisdiction or any devices intended for implantation in the human body. Should Buyer purchase or use ON Semiconductor products for any such unintended or unauthorized application, Buyer shall indemnify and hold ON Semiconductor and its officers, employees, subsidiaries, affiliates, and distributors harmless against all claims, costs, damages, and expenses, and reasonable attorney fees arising out of, directly or indirectly, any claim of personal injury or death associated with such unintended or unauthorized use, even if such claim alleges that ON Semiconductor was negligent regarding the design or manufacture of the part. ON Semiconductor is an Equal Opportunity/Affirmative Action Employer. This literature is subject to all applicable copyright laws and is not for resale in any manner.

### PUBLICATION ORDERING INFORMATION

**LITERATURE FULFILLMENT:**

Literature Distribution Center for ON Semiconductor  
 19521 E. 32nd Pkwy, Aurora, Colorado 80011 USA  
**Phone:** 303-675-2175 or 800-344-3860 Toll Free USA/Canada  
**Fax:** 303-675-2176 or 800-344-3867 Toll Free USA/Canada  
**Email:** [orderlit@onsemi.com](mailto:orderlit@onsemi.com)

**N. American Technical Support:** 800-282-9855 Toll Free  
 USA/Canada  
**Europe, Middle East and Africa Technical Support:**  
 Phone: 421 33 790 2910  
**Japan Customer Focus Center**  
 Phone: 81-3-5817-1050

**ON Semiconductor Website:** [www.onsemi.com](http://www.onsemi.com)  
**Order Literature:** <http://www.onsemi.com/orderlit>

For additional information, please contact your local Sales Representative

# Mouser Electronics

Authorized Distributor

Click to View Pricing, Inventory, Delivery & Lifecycle Information:

[ON Semiconductor:](#)

[NTD2955-1G](#) [NTD2955T4G](#)