

LOC	DIST	REVISIONS			
P	LTR	DESCRIPTION	DATE	DWN	APVD
E	B	BA1	REVISED PER ECO-11-005150	29MAR2011	RK HMR

FOR FURTHER INFORMATION SEE DATA SHEET FOR
CPF SERIES-THIN FILM PRECISION CHIP RESISTORS

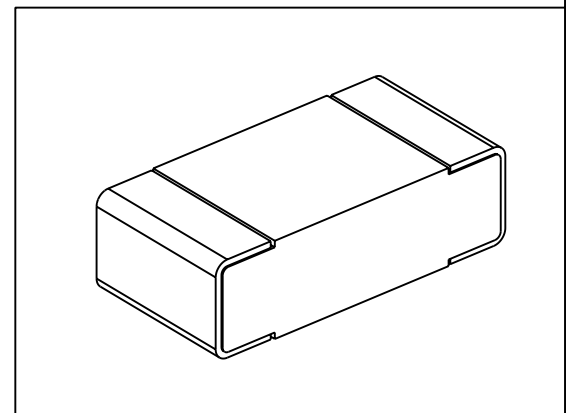
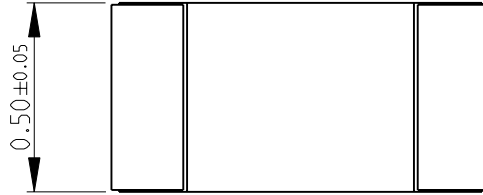

RoHS Compliant

2008

RELEASED FOR PUBLICATION

ALL RIGHTS RESERVED.

BY -

2008



THIS DRAWING IS UNPUBLISHED.

DIMENSIONS: mm	DWN	27-Sep-08	MATERIAL	-	FINISH	-
	CHK	27-Sep-08	TE Connectivity			
TOLERANCES UNLESS OTHERWISE SPECIFIED:	APVD	27-Sep-08				
0 PLC ± 0.2	STEPHEN.P		NAME THIN FILM PRECISION CHIP RESISTORS SERIES CPF 0402			
1 PLC ± 0.1	PRODUCT SPEC	-				
2 PLC ± -	APPLICATION SPEC	-	SIZE	CAGE CODE	DRAWING NO	RESTRICTED TO
3 PLC ± -			A 4	00779	©- 1879208	-
4 PLC ± -	WEIGHT	-	CUSTOMER DRAWING			
ANGLES ± 5°			SCALE	50:1	SHEET	1 OF 1
			REV BA1			

Mouser Electronics

Authorized Distributor

Click to View Pricing, Inventory, Delivery & Lifecycle Information:

[TE Connectivity:](#)

[CPF0402B100KE1](#)