

# Bluetooth / WLAN / WiFi Ceramic Chip Antenna

Ground cleared under antenna, clearance area 4.00 x 4.25/6.25 mm. Pulse Part Number W3008, W3008C



## Features

- Omni directional radiation
- Low profile
- Compact size W x L x H (3.2 x 1.6 x 1.1 mm)
- Low weight (33 mg)
- Fully SMD compatible
- Lead free soldering compatible
- Tape and reel packing
- RoHS Compliant Product

## Applications

- Bluetooth, WLAN, WiFi
- IEEE 802.11b/g
- ZigBee IEEE 802.15.4
- 2.4 GHz WLAN
- 2.4 GHz ISM Band Systems

## Electrical specifications @ +25 °C

*Note: Electrical characteristics depend on test board (GP) size and antenna positioning on GP and Ground Clearance area size.*

### Bluetooth, W3008

Typical performance (test board size 80x37 mm, PWB ground clearance area 4.00 x 4.25 mm)

Frequency Range [MHz]	Linear Max Gain [dBi]	Efficiency [%] / [dB]	Return loss min. [dB]	Impedance [ $\Omega$ ]	Operating Temperature [°C]
2400–2483.5	1.7 (Peak) 0.7 (Band edges)	70 / -1.6 (Peak) 55 / -2.6 (Band edges)	-8	50	-40 to +85

### Bluetooth / WLAN / WiFi, W3008C

Typical performance (test board size 80x37 mm, PWB ground clearance area 4.00 x 6.25 mm)

Frequency Range [MHz]	Linear Max Gain [dBi]	Efficiency [%] / [dB]	Return loss min. [dB]	Impedance [ $\Omega$ ]	Operating Temperature [°C]
2400–2483.5	2.2 (Peak) 1.9 (Band edges)	75 / -1.3 (Peak) 70 / -1.6 (Band edges)	-11	50	-40 to +85

#### Pulse Finland Oy

Takatie 6  
90440 Kempele, Finland  
Tel: +358 207 935 500  
Fax: +358 207 935 501  
[www.pulseeng.com/antennas](http://www.pulseeng.com/antennas)



# Bluetooth / WLAN / WiFi Ceramic Chip Antenna

## Terminal Configuration

### PWB Layout

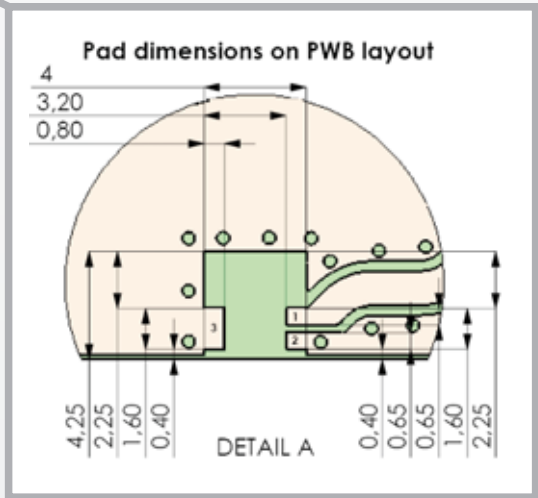
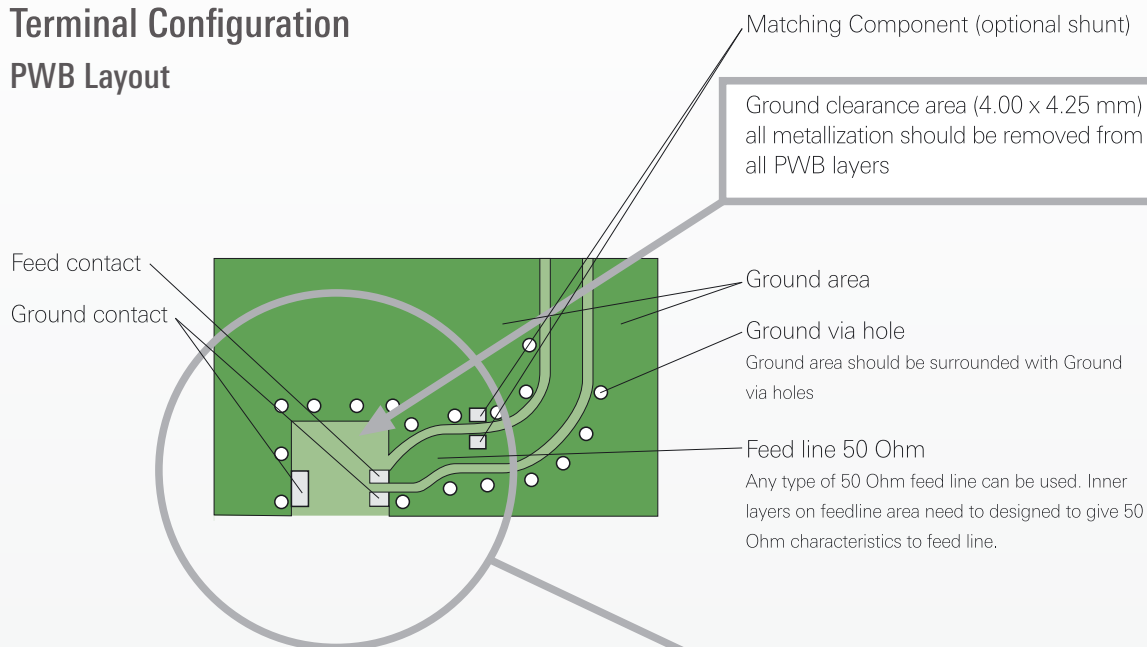

### PWB features

No.	Terminal name	Terminal Dimensions
1	Feed	0.8 x 0.65 mm
2	GND	0.8 x 0.65 mm
3	GND	0.8 x 1.60 mm

#### Pulse Finland Oy

Takatie 6  
90440 Kempele, Finland  
Tel: +358 207 935 500  
Fax: +358 207 935 501  
[www.pulseeng.com/antennas](http://www.pulseeng.com/antennas)



# Bluetooth / WLAN / WiFi Ceramic Chip Antenna

## Terminal Configuration

### PWB Layout

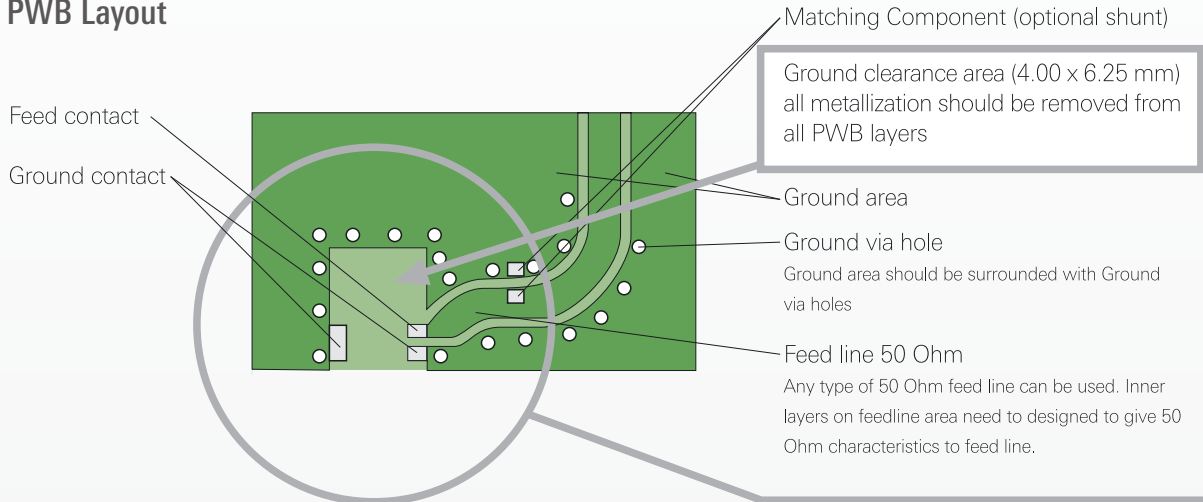

### Antenna

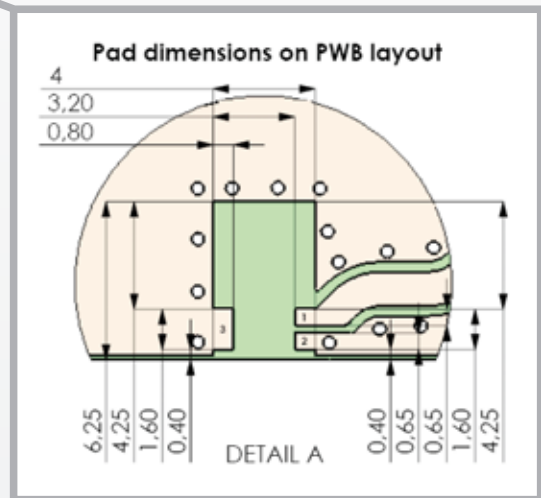
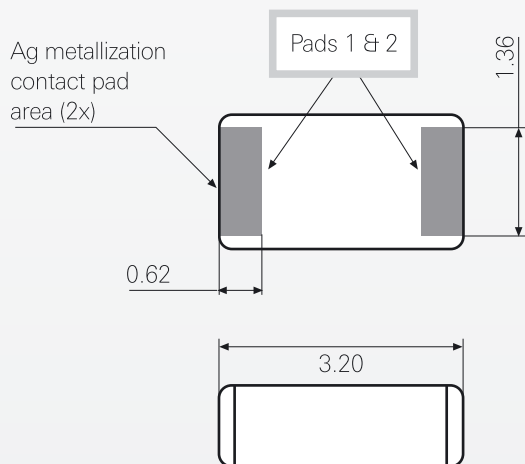

### Antenna features

No.	Terminal name	Terminal Dimensions
1	Feed / GND	0.62 x 1.36 mm
2	Feed / GND	0.62 x 1.36 mm

Antenna is symmetrical.

Either of terminals 1 or 2 can be feed / GND

### PWB features

No.	Terminal name	Terminal Dimensions
1	Feed	0.8 x 0.65 mm
2	GND	0.8 x 0.65 mm
3	GND	0.8 x 1.60 mm

# Bluetooth / WLAN / WiFi Ceramic Chip Antenna

## Typical Electrical Characteristics (T=25 °C), W3008

Typical Return Loss S11/ impedance, measured on the test board

**BT**

20 Oct 2005 12:37:16

CH1 S11&MLOG 5 dB/REF 0 dB

CH1Markers

1. -8.1915 dB 2.40000 GHz
2. -18.312 dB 2.440.000.000 MHz
3. -8.2296 dB 2.48350 GHz

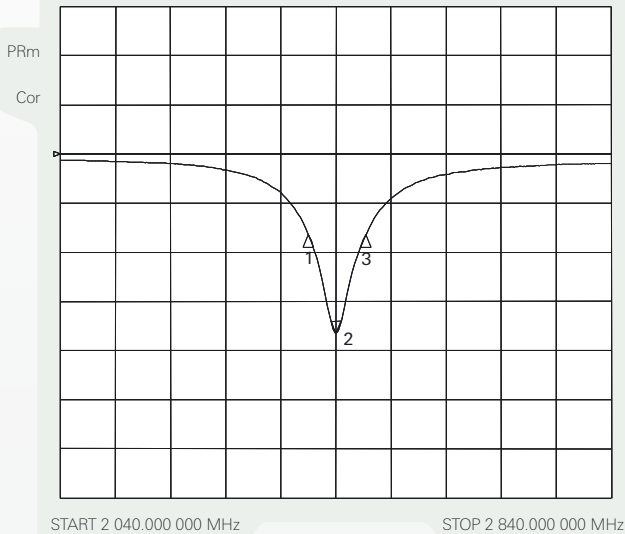

**BT**

20 Oct 2005 12:39:25

CH1Markers

- |             |           |             |
|-------------|-----------|-------------|
| 1. 27.585 Ω | 22.421 Ω  | 2.40000 GHz |
| 2. 62.148 Ω | 6.8613 Ω  | 447.55 pH   |
| 3. 45.029 Ω | -40.875 Ω | 2.48350 GHz |

CH1 S11&M1 U FS

PRm

Del

Cor

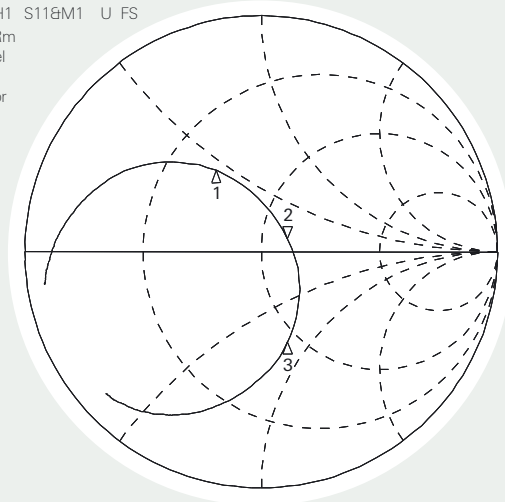

Free space efficiency and maximum gain / PWB ground clearance area 4.00 x 4.25 mm

### BT GC 3.2 x 1.6 x 1.1 mm

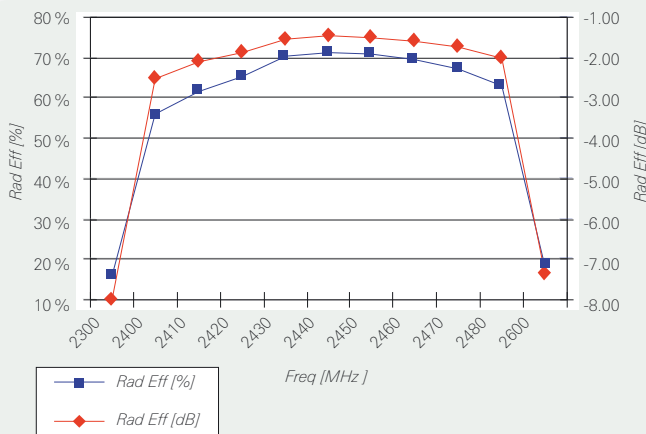

### BT GC 3.2 x 1.6 x 1.1 mm

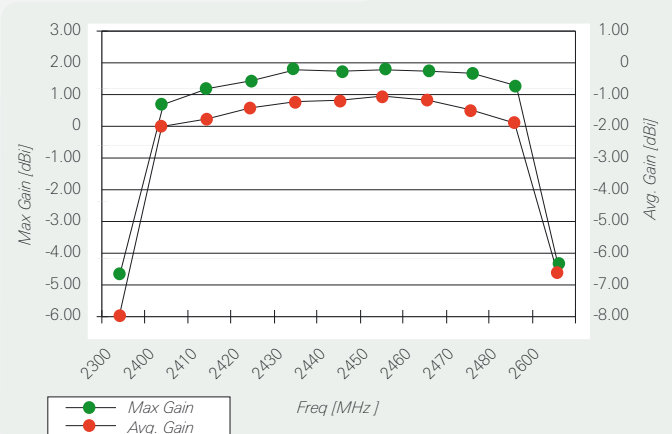

Pulse Finland Oy

Takatie 6  
90440 Kempele, Finland  
Tel: +358 207 935 500  
Fax: +358 207 935 501  
[www.pulseeng.com/antennas](http://www.pulseeng.com/antennas)



# Bluetooth / WLAN / WiFi Ceramic Chip Antenna

## Typical Free Space Radiation Patterns, W3008

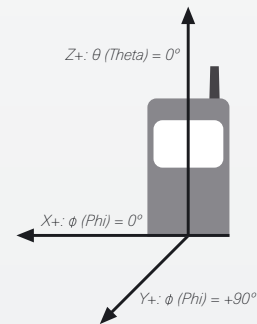
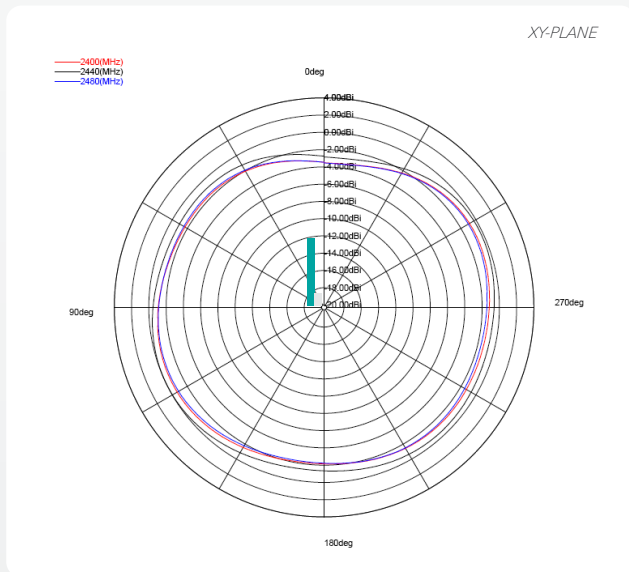
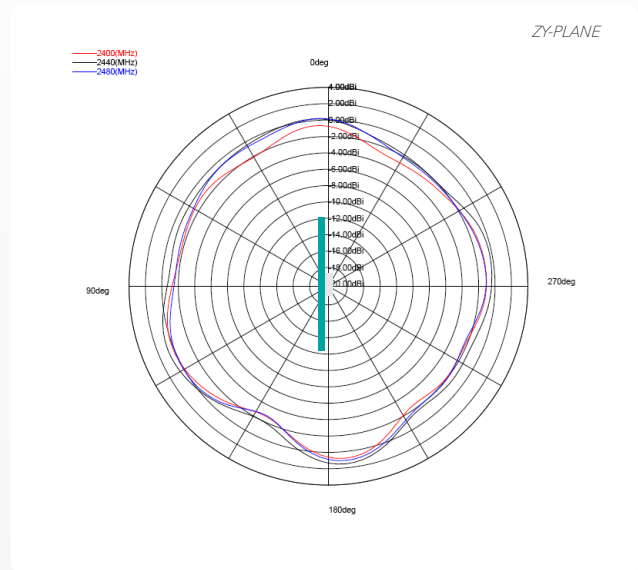
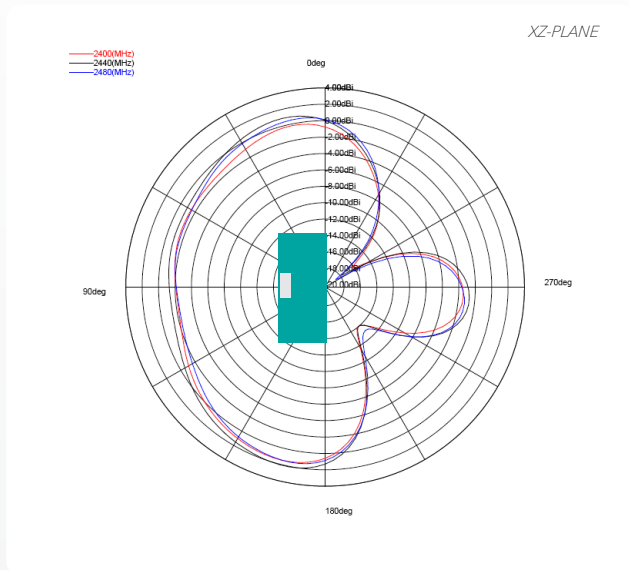

Pulse Finland Oy

Takatie 6  
 90440 Kempele, Finland

Tel: +358 207 935 500

Fax: +358 207 935 501

[www.pulseeng.com/antennas](http://www.pulseeng.com/antennas)



# Bluetooth / WLAN / WiFi Ceramic Chip Antenna

## Typical Electrical Characteristics (T=25 °C), W3008C

Typical Return Loss S11/ impedance, measured on the test board

### BT/WLAN

20 Oct 2005 12:36:03

CH1 S11&MLOG 5 dB/REF 0 dB

#### CH1Markers

1. -11.415 dB 2.40000 GHz
2. -11.464 dB 2.440.000 000 MHz
3. -27.875 dB 2.48350 GHz

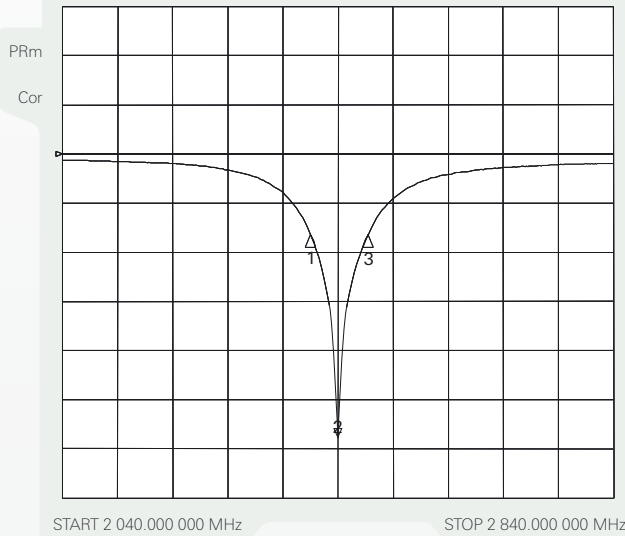

### BT/WLAN

20 Oct 2005 12:39:25

#### CH1Markers

1. 40.141 Ω 24.354 Ω 2.40000 GHz
2. 55.264 Ω 1.3613 Ω 88.796 pH
3. 40.658 Ω -25.082 Ω 2.48350 GHz

CH1 S11&M1 U FS  
PRm  
Del  
Cor

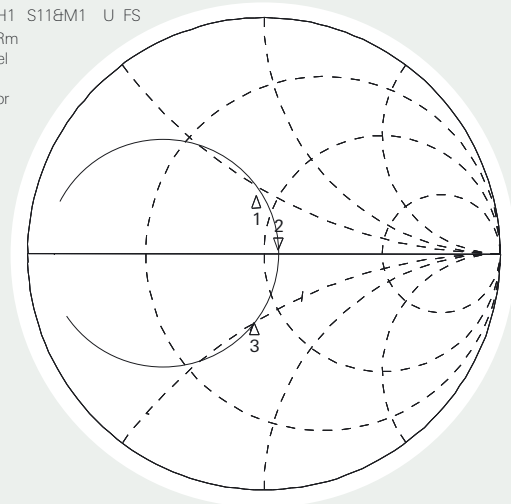

Free space efficiency and maximum gain / PWB ground clearance area 4.00 x 6.25 mm

### BT GC 3.2 x 1.6 x 1.1 mm

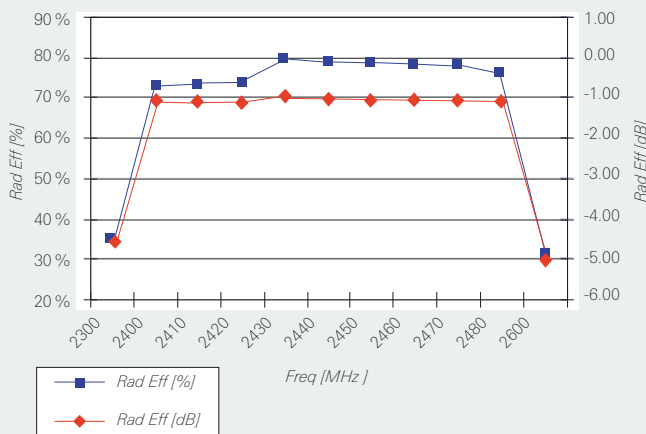

### BT GC 3.2 x 1.6 x 1.1 mm

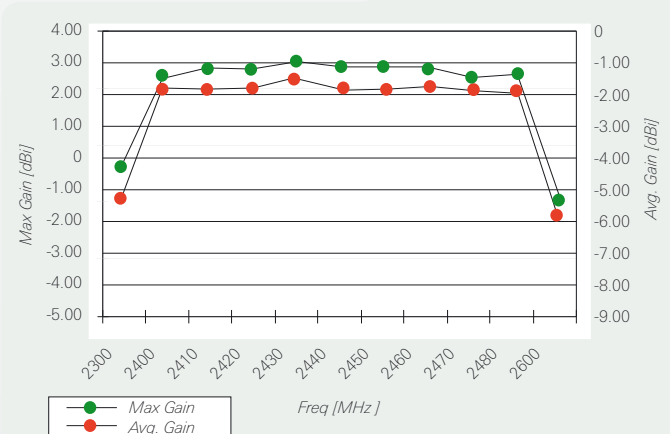

Pulse Finland Oy

Takatie 6  
90440 Kempele, Finland  
Tel: +358 207 935 500  
Fax: +358 207 935 501  
[www.pulseeng.com/antennas](http://www.pulseeng.com/antennas)



# Bluetooth / WLAN / WiFi Ceramic Chip Antenna

## Typical Free Space Radiation Patterns , W3008C

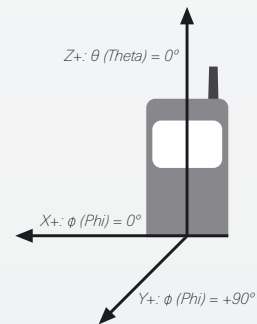
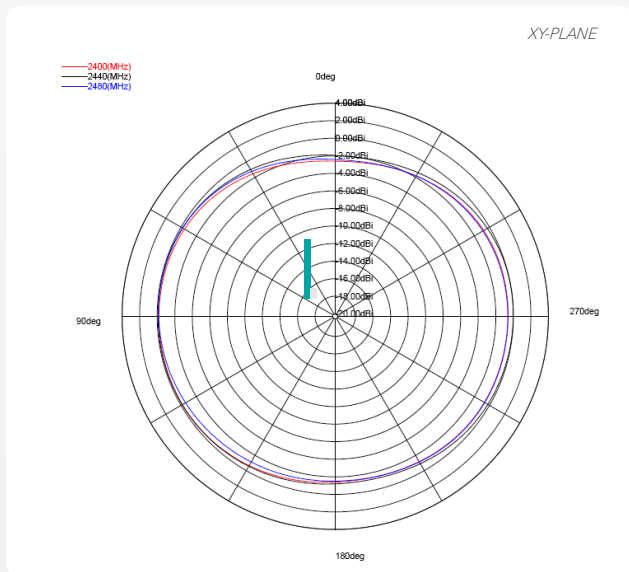
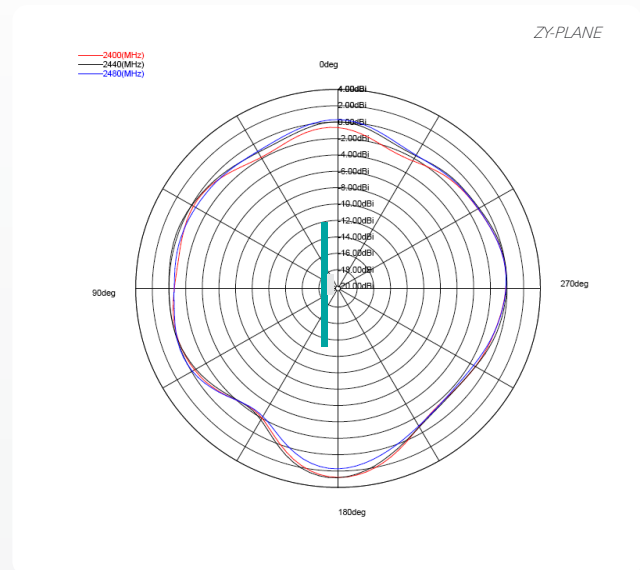
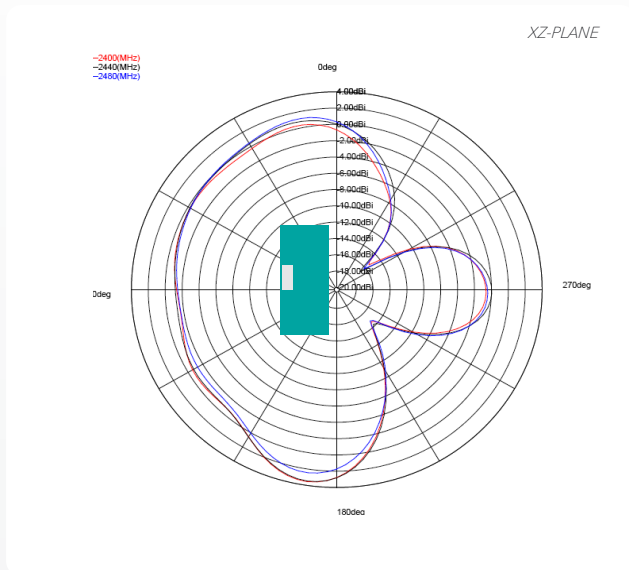

Pulse Finland Oy

Takatie 6  
 90440 Kempele, Finland

Tel: +358 207 935 500

Fax: +358 207 935 501

[www.pulseeng.com/antennas](http://www.pulseeng.com/antennas)



# Bluetooth / WLAN / WiFi Ceramic Chip Antenna

## Packing Form

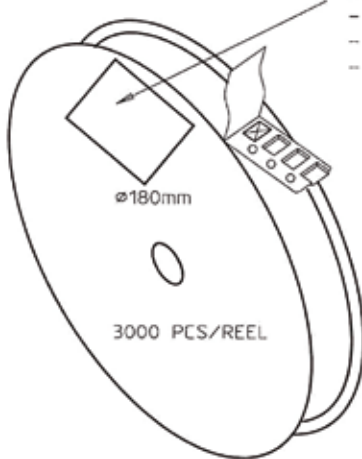

ø180mm  
3000 PCS/REEL

**REEL LABEL INFORMATION:**

- TRACEABILITY
- QUANTITY
- PRODUCT CODE

**CARRIER TAPE H85-00125**  
width=8,00 depth=1,22

**COVER TAPE H85-00126**  
width=5,60

**LENGTH OF TAPE:**

- Leader section: 50 empty cavities before component section
- Trailer section: 25 empty cavities after component section.

Empty part cavities at leader and trailer section of the tape must be sealed with top cover tape.

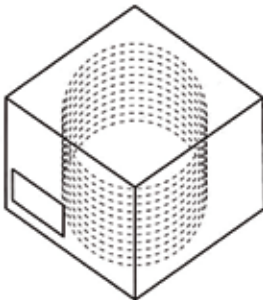

BOX H85-00128 (182x182x132)	1 pcs	
- LABEL	1 pcs/BOX	
REEL H85-00127 (D180, W12)	10 pcs	
- REEL LABEL	1 pcs/REEL	

<b>MATERIAL</b>					
<b>HANDLINGS</b>					
		<b>RATIO</b>	<b>DRWN</b>	010305 PeHa H	
			<b>DGNER</b>		G
			<b>CHKD</b>		F
			<b>APPRD</b>		E
<b>PRODUCT</b>	H90-OY116-F01P01		<b>APPRD BY</b>		D
<b>DENOMINATION</b>	PACKING FORM				C
					B
					A
	<b>VERSION</b>		<b>MOD/DATE/NAME</b>		



# Mouser Electronics

Authorized Distributor

Click to View Pricing, Inventory, Delivery & Lifecycle Information:

Pulse:

[W3008](#) [W3008C](#) [W3008-K](#) [W1920G3658](#)