

DATA SHEET

ARRAY CHIP RESISTORS

YC/TC

5%, 1%

sizes

YC: 102/104/122/124/162/164/248/324/158T/358L/358T

TC: 122/124/164

RoHS compliant



SCOPE

This specification describes YC (convex, flat) and TC (concave) series chip resistor arrays with lead-free terminations made by thick film process.

APPLICATIONS

- Terminal for SDRAM and DDRAM
- Computer applications: laptop computer, desktop computer
- Consume electronic equipments: PDAs, PNDs
- Mobile phone, telecom...

FEATURES

- AEC-Q200 qualified
- More efficient in pick & place application
- Low assembly costs
- RoHS compliant
- Products with lead free terminations meet RoHS requirements
- Pb-glass contained in electrodes
- Resistor element and glass are exempted by RoHS
- Reducing environmentally hazardous wastes
- High component and equipment reliability
- Saving of PCB space
- None forbidden-materials used in products/production
- Halogen Free Epoxy

ORDERING EXAMPLE

The ordering code of a YC122 convex chip resistor array, value 1,000 Ω with ±5% tolerance, supplied in 7-inch tape reel is: YC122-JR-071KL.

YC158T network, value 100,000Ω with 5% tolerance, supplied in 7-inch tape reel is: YC158TJR-07100KL

NOTE

1. All our RSMD products meet RoHS compliant. "LFP" of the internal 2D reel label mentions "Lead Free Process"
2. On customized label, "LFP" or specific symbol printed and the optional "L" at the end of GLOBAL PART NUMBER / I2NC can be added (both are on customer request)

ORDERING INFORMATION - GLOBAL PART NUMBER & I2NC

Both part numbers are identified by the series, size, tolerance, packing type, temperature coefficient, taping reel and resistance value.

YAGEO BRAND ordering code

GLOBAL PART NUMBER (PREFERSRED)

YC **XXXX** **X** **X** **X** **X** **XX** **XXXX** **L/T**
TC (1) (2) (3) (4) (5) (6) (7) (8)

(1) SIZE

YC:102/104/122/124/162/164/248/324/158T/358L/358T
 TC: 122/124/164

(2) ARRAYS OR NETWORKS

Array YC102/104/122/124/162/164/248/324: -
 Network YC158T/YC358L/YC358T: NA

(3) TOLERANCE

F = ±1% J = ±5% (for Jumper ordering, use code of J)

(4) PACKAGING TYPE

R = Paper taping reel K = Embossed plastic tape reel

(5) TEMPERATURE COEFFICIENT OF RESISTANCE

- = Base on spec

(6) TAPING REEL

07 = 7 inch dia. Reel
 13 = 13 inch dia. Reel

(7) RESISTANCE VALUE

There are 2~4 digits indicated the resistor value. Letter R/K/M is decimal point.
 Detailed resistance rules show in table of "Resistance rule of global part number".

(8) DEFAULT CODE

Letter L is the system default code for ordering only. (Note)
 Letter T is the only default code for YC102.

| Resistance rule of global part number | |
|---------------------------------------|--|
| Resistance code rule | Example |
| OR | OR = Jumper |
| XRXX (1 to 9.76 Ω) | IR = 1 Ω IR5 = 1.5 Ω 9R76 = 9.76 Ω |
| XXRX (10 to 97.6 Ω) | I0R = 10 Ω 97R6 = 97.6 Ω |
| XXXR (100 to 976 Ω) | I00R = 100 Ω |
| XKXX (1 to 9.76 KΩ) | IK = 1,000 Ω 9K76 = 9760 Ω |
| XM (1 MΩ) | IM = 1,000,000 Ω |

PHYCOMP BRAND ordering codes

Both GLOBAL PART NUMBER (preferred) and I2NC (traditional) codes are acceptable to order Phycomp brand products.

GLOBAL PART NUMBER (PREFERRED)

For detailed information of GLOBAL PART NUMBER and ordering example, please refer to page 2. TC122 series is supplied and ordered by global part number only.

I2NC CODE

| TYPE/ 2×0402 | 2350 | XXX XXXXX L | | | | PAPER / PE TAPE ON REEL (units) ⁽²⁾ | |
|-----------------|------|-------------|------------|-----|-----------|--|--|
| | (1) | (2) | (3) | (4) | 10,000 | 50,000 | |
| ARV321 | 2350 | ±5% | 1 to 1 MΩ | | 013 11xxx | 013 12xxx | |
| ARV322 | 2350 | ±1% | 10 to 1 MΩ | | 013 2xxxx | 013 3xxxx | |
| Jumper | 2350 | - | 0 Ω | | 013 91001 | - | |

| Last digit of I2NC Resistance decade ⁽³⁾ | Last digit |
|--|------------|
| 0.01 to 0.0976 Ω | 0 |
| 0.1 to 0.976 Ω | 7 |
| 1 to 9.76 Ω | 8 |
| 10 to 97.6 Ω | 9 |
| 100 to 976 Ω | 1 |
| 1 to 9.76 KΩ | 2 |
| 10 to 97.6 KΩ | 3 |
| 100 to 976 KΩ | 4 |
| 1 to 9.76 MΩ | 5 |
| 10 to 97.6 MΩ | 6 |

- (1) The resistors have a 12-digit ordering code starting with 2350.
- (2) The subsequent 4 or 5 digits indicate the resistor tolerance and packaging.
- (3) The remaining 4 or 3 digits represent the resistance value with the last digit indicating the multiplier as shown in the table of "Last digit of I2NC".
- (4) "L" is optional symbol ^(Note).

Example:

| | | |
|--------|---|-------------|
| 0.02 Ω | = | 0200 or 200 |
| 0.3 Ω | = | 3007 or 307 |
| 1 Ω | = | 1008 or 108 |
| 33 KΩ | = | 3303 or 333 |
| 10 MΩ | = | 1006 or 106 |

ORDERING EXAMPLE

The ordering code of a ARV321 resistor, value 1,000Ω with ±5% tolerance, supplied in tape of 10,000 units per reel is: 235001311102(L) or YC122-JR-071KL.

NOTE

- 1. All our RSMD products are RoHS compliant. "LFP" of the internal 2D reel label mentions "Lead Free Process"
- 2. On customized label, "LFP" or specific symbol printed and the optional "L" at the end of GLOBAL PART NUMBER / I2NC can be added (both are on customer request)

MARKING

YCI02



YCI22



YCI04

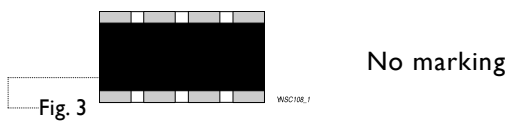

YCI24 / 162 / 164 / 324

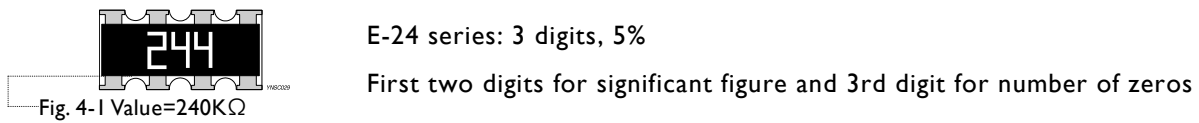
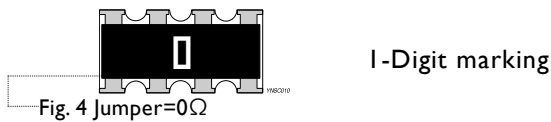

YC248

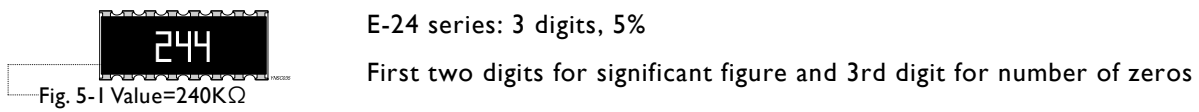
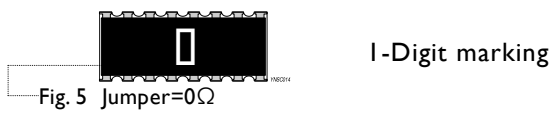

YCI58T/358L/358T



TCI22



TCI24

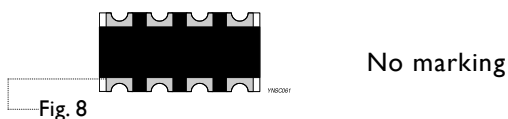

TCI64



I-Digit marking

Fig. 9 Jumper=0Ω



E-24 series: 3 digits, 5%

First two digits for significant figure and 3rd digit for number of zeros

Fig. 9-1 Value=240KΩ

For further marking information, please refer to data sheet “Chip resistors marking”.

CONSTRUCTION

The resistor is constructed on top of a high-grade ceramic body. Internal metal electrodes are added on each end to make the contacts to the thick film resistive element. The composition of the resistive element is a noble metal imbedded into a glass and covered by a second glass to prevent environment influences. The resistor is laser trimmed to the rated resistance value. The resistor is covered with a protective epoxy coat, finally the two external terminations (matte tin on Ni-barrier) are added as shown in Fig.9.

OUTLINES

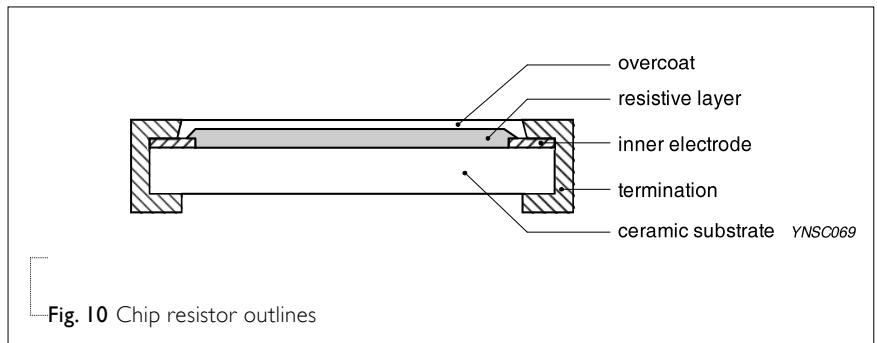

SCHEMATIC

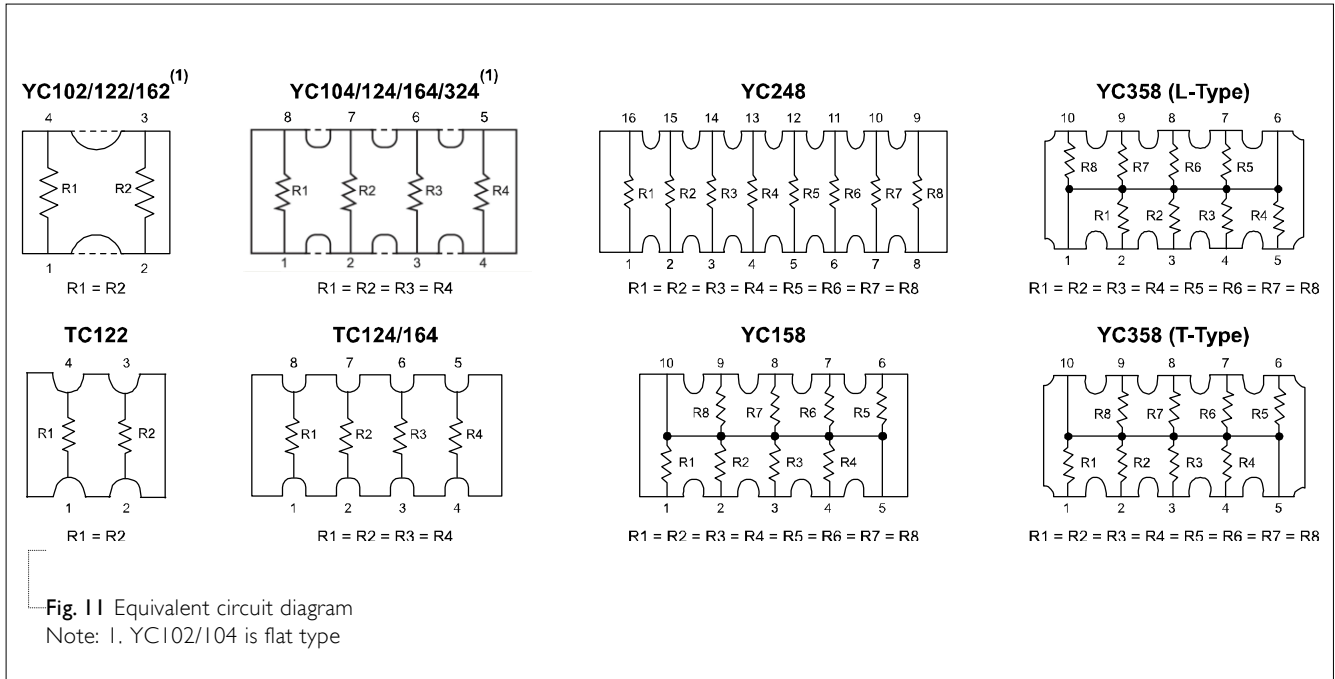

DIMENSIONS

Table I

| TYPE | H / H _I / H _W | B | P | L | T | W1 | W2 |
|--------|--|-------------|-------------|-------------|-------------|-------------|-------------|
| YC102 | H: 0.25 ± 0.10 | 0.15 ± 0.10 | 0.55 ± 0.10 | 0.80 ± 0.10 | 0.35 ± 0.10 | 0.15 ± 0.10 | 0.60 ± 0.10 |
| YC104 | H: 0.20 ± 0.10 | 0.15 ± 0.05 | 0.40 ± 0.10 | 1.40 ± 0.10 | 0.35 ± 0.10 | 0.15 ± 0.10 | 0.60 ± 0.10 |
| YC122 | H: 0.21+0.10 / -0.05 H _W : 0.35 ± 0.10 | 0.20 ± 0.10 | 0.67 ± 0.05 | 1.00 ± 0.10 | 0.30 ± 0.10 | 0.25 ± 0.10 | 1.00 ± 0.10 |
| YC124 | H: 0.40 ± 0.15 H _I : 0.30 ± 0.05 | 0.20 ± 0.15 | 0.50 ± 0.05 | 2.00 ± 0.10 | 0.45 ± 0.10 | 0.30 ± 0.15 | 1.00 ± 0.10 |
| YC162 | H: 0.30 ± 0.10 H _W : 0.65 ± 0.15 | 0.30 ± 0.10 | 0.80 ± 0.05 | 1.60 ± 0.10 | 0.40 ± 0.10 | 0.30 ± 0.10 | 1.60 ± 0.10 |
| YC164 | H: 0.65 ± 0.05 H _I : 0.50 ± 0.15 | 0.30 ± 0.15 | 0.80 ± 0.05 | 3.20 ± 0.15 | 0.60 ± 0.10 | 0.30 ± 0.15 | 1.60 ± 0.15 |
| YC248 | H: 0.45 ± 0.05 H _I : 0.30 ± 0.05 | 0.30 ± 0.15 | 0.50 ± 0.05 | 4.00 ± 0.20 | 0.45 ± 0.10 | 0.40 ± 0.15 | 1.60 ± 0.15 |
| YC324 | H: 1.10 ± 0.15 H _I : 0.90 ± 0.15 | 0.50 ± 0.20 | 1.27 ± 0.05 | 5.08 ± 0.20 | 0.60 ± 0.10 | 0.50 ± 0.15 | 3.20 ± 0.20 |
| TC122 | H: 0.30 ± 0.05 | 0.25 ± 0.15 | 0.50 ± 0.05 | 1.00 ± 0.10 | 0.30 ± 0.10 | 0.25 ± 0.15 | 1.00 ± 0.10 |
| TC124 | H: 0.30 ± 0.10 | 0.20 ± 0.10 | 0.50 ± 0.05 | 2.00 ± 0.10 | 0.40 ± 0.10 | 0.25 ± 0.10 | 1.00 ± 0.10 |
| TC164 | H: 0.50 ± 0.15 | 0.30 ± 0.15 | 0.80 ± 0.05 | 3.20 ± 0.15 | 0.60 ± 0.10 | 0.30 ± 0.15 | 1.60 ± 0.15 |
| YC158T | H: 0.45 ± 0.05 H _I : 0.32 ± 0.05 | 0.30 ± 0.15 | 0.64 ± 0.05 | 3.20 ± 0.20 | 0.60 ± 0.10 | 0.35 ± 0.15 | 1.60 ± 0.15 |
| YC358L | H: 1.10 ± 0.15 | 0.50 ± 0.15 | 1.27 ± 0.05 | 6.40 ± 0.20 | 0.60 ± 0.10 | 0.50 ± 0.15 | 3.20 ± 0.20 |
| YC358T | H _I : 0.90 ± 0.15 | | | | | | |

ELECTRICAL CHARACTERISTICS

Table 2

| TYPE | POWER P ₇₀ | OPERATING TEMP. RANGE | MWV | RCOV | DWV | RESISTANCE RANGE & TOLERANCE | T. C. R. | Jumper criteria (unit: A) |
|------------------|--------------------------|--------------------------|-------|------|------|--|---|--|
| YC102 | 1/32W | -55°C to +125°C | 15V | 30V | 30V | E24 ±5% 10Ω ≤ R ≤ 1MΩ E24/E96 ±1% 10Ω ≤ R ≤ 1MΩ Jumper < 0.05Ω | ±200 ppm/°C | Rated current 0.5 Max. current 1.0 |
| YC104 | 1/32W | -55°C to +125°C | 12.5V | 25V | 25V | E24 ±5% 10Ω ≤ R ≤ 1MΩ E24/E96 ±1% 10Ω ≤ R ≤ 1MΩ Jumper < 0.05Ω | ±200 ppm/°C | Rated current 0.5 Max. current 1.0 |
| YC122 | 1/16W | -55°C to +155°C | 50V | 100V | 100V | E24 ±5% 1Ω ≤ R ≤ 1MΩ E24/E96 ±1% 1Ω ≤ R ≤ 1MΩ Jumper < 0.05Ω | ±200 ppm/°C | Rated current 0.5 Max. current 1.0 |
| YC124 | 1/16W | -55°C to +155°C | 25V | 50V | 100V | E24 ±5% 1Ω ≤ R ≤ 1MΩ E24/E96 ±1% 1Ω ≤ R ≤ 1MΩ Jumper < 0.05Ω | 1Ω ≤ R ≤ 10Ω ±250 ppm/°C 10Ω ≤ R ≤ 1MΩ ±200 ppm/°C | Rated current 1.0 Max. current 2.0 |
| YC162 | 1/16W | -55°C to +155°C | 50V | 100V | 100V | E24 ±5% 1Ω ≤ R ≤ 1MΩ E24/E96 ±1% 1Ω ≤ R ≤ 1MΩ Jumper < 0.05Ω | ±200 ppm/°C | Rated current 1.0 Max. current 2.0 |
| YC164 | 1/16W | -55°C to +155°C | 50V | 100V | 100V | E24 ±5% 1Ω ≤ R ≤ 1MΩ E24/E96 ±1% 1Ω ≤ R ≤ 1MΩ Jumper < 0.05Ω | ±200 ppm/°C | Rated current 1.0 Max. current 2.0 |
| YC248 | 1/16W | -55°C to +155°C | 50V | 100V | 100V | E24 ±5% 10Ω ≤ R ≤ 1MΩ E24/E96 ±1% 10Ω ≤ R ≤ 1MΩ Jumper < 0.05Ω | ±200 ppm/°C | Rated current 2.0 Max. current 10.0 |
| YC324 | 1/8W | -55°C to +155°C | 200V | 500V | 500V | E24 ±5% 10Ω ≤ R ≤ 1MΩ E24/E96 ±1% 10Ω ≤ R ≤ 1MΩ | ±200 ppm/°C | --- |
| TC122 | 1/16W | -55°C to +125°C | 50V | 100V | 100V | E24 ±5% 10Ω ≤ R ≤ 1MΩ E24/E96 ±1% 10Ω ≤ R ≤ 1MΩ Jumper < 0.05Ω | ±200 ppm/°C | Rated current 1.0 Max. current 1.5 |
| TC124 | 1/16W | -55°C to +125°C | 50V | 100V | 100V | E24 ±5% 10Ω ≤ R ≤ 1MΩ E24/E96 ±1% 10Ω ≤ R ≤ 1MΩ Jumper < 0.05Ω | ±200 ppm/°C | Rated current 1.0 Max. current 1.5 |
| TC164 | 1/16W | -55°C to +155°C | 50V | 100V | 100V | E24 ±5% 10Ω ≤ R ≤ 1MΩ E24/E96 ±1% 10Ω ≤ R ≤ 1MΩ Jumper < 0.05Ω | ±200 ppm/°C | Rated current 1.0 Max. current 2.0 |
| YC158T | 1/16W | -55°C to +155°C | 25V | 50V | 50V | E24 ±5% 10Ω ≤ R ≤ 100KΩ | ±200 ppm/°C | --- |
| YC358L YC358T | 1/16W | -55°C to +155°C | 50V | 100V | 100V | E24 ±5% 10Ω ≤ R ≤ 330KΩ | ±200 ppm/°C | --- |

FOOTPRINT AND SOLDERING PROFILES

For recommended footprint and soldering profiles, please refer to data sheet “Chip resistors mounting”.

PACKING STYLE AND PACKAGING QUANTITY

Table 3 Packing style and packaging quantity

| PACKING STYLE | PACKING STYLE | YC102/ 104 | YC/TC 122 | YC/TC 124 | YC162 | YC/TC 164 | YC248 | YC324 | YC158T | YC358L YC358T |
|----------------------------|---------------|---------------|--------------|--------------|-------|--------------|-------|-------|--------|------------------|
| Paper taping reel (R) | 7" (178mm) | 10,000 | 10,000 | 10,000 | 5,000 | 5,000 | 5,000 | --- | 5,000 | --- |
| | 13" (254mm) | 50,000 | 50,000 | 40,000 | --- | 20,000 | --- | --- | 20,000 | --- |
| Embossed taping reel (K) | 7" (178mm) | --- | --- | --- | --- | --- | 4,000 | 4,000 | --- | 4,000 |

NOTE

I. For tape and reel specification/dimensions, please refer to data sheet “Chip resistors packing”.

FUNCTIONAL DESCRIPTION

OPERATING TEMPERATURE RANGE

YC102/104/122/162, TC122/124 Range:

-55°C to +125°C (Fig.13)

YC124/164/248/324/158T/358L/358T, TC164 Range:

-55°C to +155°C(Fig.14)

POWER RATING

Each type rated power at 70°C

YC102/104 = 1/32 W

YC122/124/162/164/248/158T/358L/358T = 1/16 W

YC324 = 1/8 W

TC122/124/164 = 1/16 W

RATED VOLTAGE

The DC or AC (rms) continuous working voltage corresponding to the rated power is determined by the following formula:

$$V = \sqrt{(P \times R)}$$

or max. working voltage whichever is less

Where

V=Continuous rated DC or AC (rms) working voltage (V)

P=Rated power (W)

R=Resistance value (Ω)

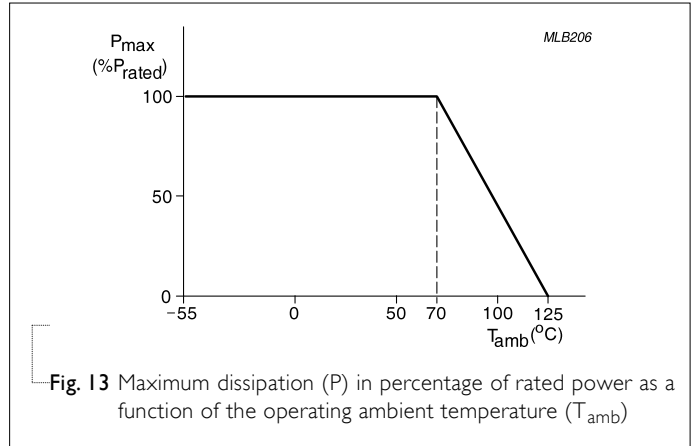

TESTS AND REQUIREMENTS
Table 4 Test condition, procedure and requirements

| TEST | TEST METHOD | PROCEDURE | REQUIREMENTS |
|--|------------------------|---|--|
| Life/ Operational Life/ Endurance | MIL-STD-202-method 108 | 1,000 hours at 70±5 °C applied RCWV | ±(2%+0.05 Ω) |
| | IEC 60115-1 4.25.1 | 1.5 hours on, 0.5 hour off, still air required | <100 mΩ for Jumper |
| | JIS C 5202-7.10 | | |
| High Temperature Exposure/ Endurance at Upper Category Temperature | MIL-STD-202-method 108 | 1,000 hours at maximum operating | ±(1%+0.05 Ω) |
| | IEC 60115-1 4.25.3 | temperature depending on specification, unpowered | <50 mΩ for Jumper |
| | JIS C 5202-7.11 | No direct impingement of forced air to the parts Tolerances: 125±3 °C | |
| Moisture Resistance | MIL-STD-202-method 106 | Each temperature / humidity cycle is defined at | ±(2%+0.05 Ω) |
| | IEC 60115-1 4.24.2 | 8 hours (method 106F), 3 cycles / 24 hours for 10d with 25 °C / 65 °C 95% R.H, without steps 7a & 7b, unpowered | <100 mΩ for Jumper |
| | | Parts mounted on test-boards, without condensation on parts Measurement at 24±2 hours after test conclusion | |
| Thermal Shock | MIL-STD-202-method 107 | -55/+125 °C | ±(1%+0.05 Ω) |
| | | Note: Number of cycles required is 300. Devices mounted | <50 mΩ for Jumper |
| | | Maximum transfer time is 20 seconds. Dwell time is 15 minutes. Air – Air | |
| Short Time Overload | MIL-R-55342-para 4.7.5 | 2.5 times RCWV or maximum overload | ±(2%+0.05 Ω) |
| | IEC60115-1 4.13 | voltage whichever is less for 5 sec at room temperature | <50 mΩ for Jumper No visible damage |
| Board Flex/ Bending | IEC60115-1 4.33 | Device mounted on PCB test board as described, only 1 board bending required | ±(1%+0.05 Ω) |
| | | 3 mm bending | <50 mΩ for Jumper |
| | | Bending time: 60±5 seconds Ohmic value checked during bending | No visible damage |

| TEST | TEST METHOD | PROCEDURE | REQUIREMENTS |
|-----------------------------------|---|--|--|
| Solderability - Wetting | J-STD-002 test | Electrical Test not required Magnification 50X SMD conditions: 1 st step: method B, aging 4 hours at 155 °C dry heat 2 nd step: leadfree solder bath at 245±3 °C Dipping time: 3±0.5 seconds | Well tinned (≥95% covered) No visible damage |
| - Leaching | J-STD-002 test | Leadfree solder, 260 °C, 30 seconds immersion time | No visible damage |
| - Resistance to Soldering Heat | MIL-STD-202-method 210 | Condition B, no pre-heat of samples Leadfree solder, 260 °C, 10 seconds immersion time Procedure 2 for SMD: devices fluxed and cleaned with isopropanol | ±(1%+0.05 Ω) <50 mΩ for Jumper No visible damage |
| Biased Humidity | AEC-Q200 Test 7 MIL-STD-202-Method 103 | 1,000 hours; 85 °C / 85% RH 10% of operating power Measurement at 24± 4 hours after test conclusion. | ± (5.0%+0.05 Ω) |

REVISION HISTORY

| REVISION | DATE | CHANGE NOTIFICATION | DESCRIPTION |
|-----------|---------------|---------------------|--|
| Version 9 | Feb.19, 2019 | - | - Update H dimension for YC124 |
| Version 8 | Dec. 24, 2018 | - | - Update AEC-Q200 qualified |
| Version 7 | Aug. 22, 2017 | - | - Correct the typo for YC158T/358L/358T, Marking, "240" is 24ohm |
| Version 6 | Jun. 1, 2017 | - | - Update ordering information for networks YC158T/YC358L/YC358T |
| Version 5 | Feb. 14, 2017 | - | - Update YC158 and 358 part number to YC158T , YC358L and YC358T |
| Version 4 | Dec. 22, 2016 | - | - Delete YC102 default code L type |
| Version 3 | Apr. 29, 2016 | - | - Update YC series and TC164 dimension |
| Version 2 | Dec. 11, 2015 | - | - Update Operating Temperature |
| Version 1 | Feb. 04, 2015 | - | - Update YC102 to flat type |
| Version 0 | Nov. 14, 2014 | - | - First issue of this specification |

“ Yageo reserves all the rights for revising the content of this datasheet without further notification, as long as the products itself are unchanged. Any product change will be announced by PCN.”