

## Thermal Sensor with SPI™ Interface

### Features

- Digital Temperature Sensing in 5-Pin SOT-23A and 8-Pin SOIC Packages
- Outputs Temperature as a 13-Bit Digital Word
- SPI and MICROWIRE™ Compatible Interface
- Solid State Temperature Sensing
- ±1°C (max.) accuracy from +25°C to +65°C
- ±2°C (max.) accuracy from -40°C to +85°C
- ±3°C (max.) accuracy from -55°C to +125°C
- 2.7V to 5.5V Operating Range
- Low Power
  - 250 µA (typ.) Continuous Conversion Mode
  - 0.1 µA (typ.) Shutdown Mode

### Typical Applications

- Thermal Protection for Hard Disk Drives and Other PC Peripherals
- PC Card Devices for Notebook Computers
- Low Cost Thermostat Controls
- Industrial Control
- Office Equipment
- Cellular Phones
- Thermistor Replacement

### Block Diagram

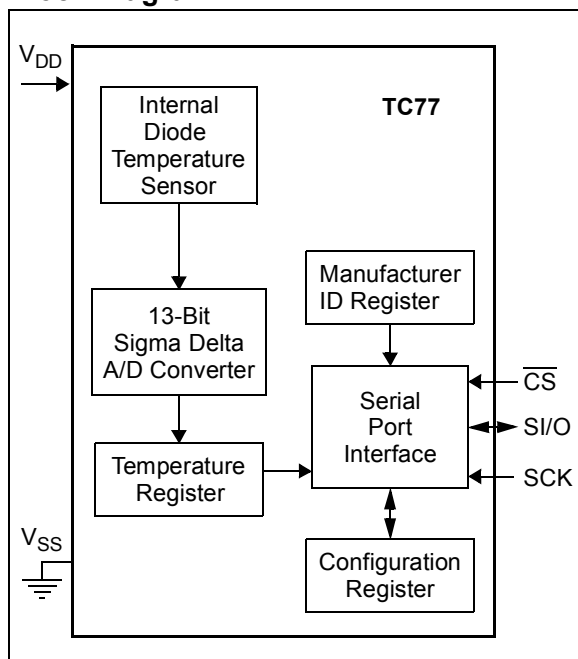

### Description

The TC77 is a serially accessible digital temperature sensor particularly suited for low cost and small form-factor applications. Temperature data is converted from the internal thermal sensing element and made available at anytime as a 13-bit two's complement digital word. Communication with the TC77 is accomplished via a SPI and MICROWIRE compatible interface. It has a 12-bit plus sign temperature resolution of 0.0625°C per Least Significant Bit (LSb). The TC77 offers a temperature accuracy of ±1.0°C (max.) over the temperature range of +25°C to +65°C. When operating, the TC77 consumes only 250 µA (typ.). The TC77's Configuration register can be used to activate the low power Shutdown mode, which has a current consumption of only 0.1 µA (typ.). Small size, low cost and ease of use make the TC77 an ideal choice for implementing thermal management in a variety of systems.

### Package Types

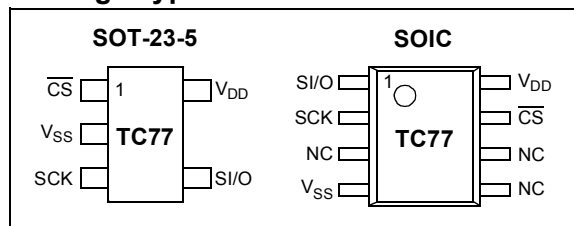

### Typical Application

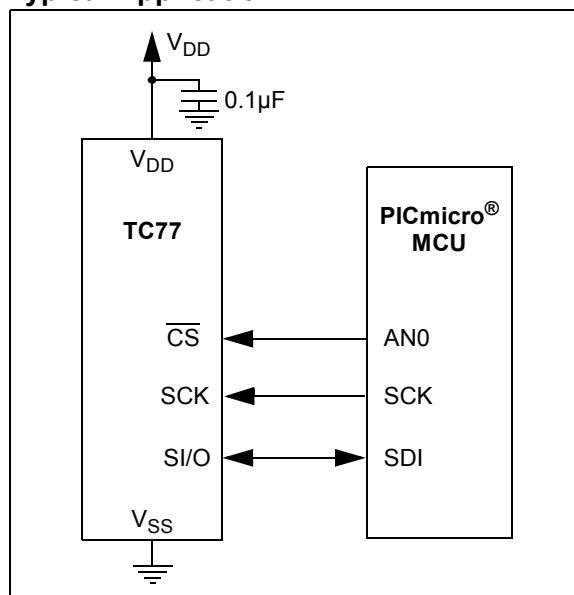

# TC77

## 1.0 ELECTRICAL CHARACTERISTICS

### 1.1 Absolute Maximum Ratings †

$V_{DD}$  ..... 6.0V  
 All inputs and outputs w.r.t.  $V_{SS}$  ..... -0.3V to  $V_{DD}$  +0.3V  
 Storage temperature ..... -65°C to +150°C  
 Ambient temp. with power applied ..... -55°C to +125°C  
 Junction Temperature ..... 150°C

ESD protection on all pins:

Human Body Model (HBM) ..... >4 kV

Machine Model (MM) ..... >200V

† **Notice:** Stresses above those listed under "Maximum Ratings" may cause permanent damage to the device. This is a stress rating only and functional operation of the device at those or any other conditions above those indicated in the operation listings of this specification is not implied. Exposure to maximum rating conditions for extended periods may affect device reliability.

## PIN FUNCTION TABLE

Name	Function
SI/O	Serial Data Pin
SCK	Serial Clock
$V_{SS}$	Ground
$\overline{CS}$	Chip Select (Active-Low)
NC	No Connection
$V_{DD}$	Power Supply

## DC CHARACTERISTICS

Electrical Specifications: Unless otherwise noted, all parameters apply at $V_{DD} = 2.7V$ to $5.5V$ and $T_A = -55^\circ C$ to $+125^\circ C$ .						
Parameters	Sym	Min	Typ	Max	Units	Conditions
<b>Power Supply</b>						
Operating Voltage Range	$V_{DD}$	2.7	—	5.5	V	<b>Note 1</b>
Operating Current	$I_{DD}$	—	250	400	$\mu A$	Continuous Temperature Conversion Mode
Power-On Reset Threshold	$V_{POR}$	1.2	1.6	2.2	V	$V_{DD}$ falling or rising edge
Standby Supply Current	$I_{DD-}$ STANDBY	—	0.1	1.0	$\mu A$	Shutdown Mode
<b>Temperature to Bits Converter</b>						
Resolution		—	13	—	Bits	ADC LSB = $0.0625^\circ C/bit$ <b>(Note 4)</b>
Temperature Conversion Time	$t_{CT}$	—	300	400	ms	
Temperature Accuracy <b>(Note 1)</b>	$T_{ERR}$	-1.0 -2.0 -3.0	— — —	+1.0 +2.0 +3.0	$^\circ C$	+25 $^\circ C$ < $T_A$ < +65 $^\circ C$ -40 $^\circ C$ < $T_A$ < +85 $^\circ C$ -55 $^\circ C$ < $T_A$ < +125 $^\circ C$ TC77-3.3MXX: $V_{DD} = 3.3V$ TC77-5.0MXX: $V_{DD} = 5.0V$

**Note 1:** The TC77-3.3MXX and TC77-5.0MXX will operate from a supply voltage of 2.7V to 5.5V. However, the temperature accuracy of the TC77-3.3MXX and TC77-5.0MXX is specified at the nominal operating voltages of 3.3V and 5.0V, respectively. As  $V_{DD}$  varies from the nominal operating value, the accuracy may be degraded (Refer to Figures 2-6 and 2-7).

**2:** All time measurements are measured with respect to the 50% point of the signal.

**3:** Load Capacitance,  $C_L = 80$  pF, is used for AC timing measurements of output signals.

**4:** Resolution = Temperature Range/No. of Bits =  $(+255^\circ C - -256^\circ C) / (2^{13})$

Resolution =  $512/8192 = 0.0625^\circ C/Bit$

## DC CHARACTERISTICS (CONTINUED)

Electrical Specifications: Unless otherwise noted, all parameters apply at $V_{DD} = 2.7V$ to $5.5V$ and $T_A = -55^{\circ}C$ to $+125^{\circ}C$ .						
Parameters	Sym	Min	Typ	Max	Units	Conditions
<b>Digital Input/Output</b>						
High Level Input Voltage	$V_{IH}$	$0.7 V_{DD}$	—	$V_{DD} + 0.3$	V	
Low Level Input Voltage	$V_{IL}$	-0.3	—	$0.3 V_{DD}$	V	
High Level Output Voltage	$V_{OH}$	2.4	—	—	V	$I_{OH} = -400 \mu A$
Low Level Output Voltage	$V_{OL}$	—	—	0.4	V	$I_{OL} = +2 \text{ mA}$
Input Current	$I_{IN(0)}$ , $I_{IN(1)}$	-1.0 -1.0	— —	+1.0 +1.0	$\mu A$	$V_{IN} = GND$ $V_{IN} = V_{DD}$
Input Hysteresis		0.35	0.8	—	V	SI/O, SCK
Pin Capacitance	$C_{IN}$ , $C_{OUT}$	—	20	—	pF	
Tri-state Output Leakage Current	$I_{O\_LEAK}$	-1.0 —	— —	— +1.0	$\mu A$	$V_O = GND$ $V_O = V_{DD}$
<b>Serial Port AC Timing (Notes 2, 3)</b>						
Clock Frequency	$f_{CLK}$	DC	—	7.0	MHz	
$\overline{CS}$ Fall to First Rising SCK Edge	$t_{CS-SCK}$	100	—	—	ns	
$\overline{CS}$ Low to Data Out Delay	$t_{CS-SI/O}$	—	—	70	ns	
SCK Fall to Data Out Delay	$t_{DO}$	—	—	100	ns	
$\overline{CS}$ High to Data Out Tri-state	$t_{DIS}$	—	—	200	ns	
SCK High to Data In Hold Time	$t_{HD}$	50	—	—	ns	
Data In Set-up Time	$t_{SU}$	30	—	—	ns	
<b>Thermal Package Resistance</b>						
Thermal Resistance, SOT23-5	$\theta_{JA}$	—	230	—	$^{\circ}C/W$	
Thermal Resistance, 8L-SOIC	$\theta_{JA}$	—	163	—	$^{\circ}C/W$	

**Note 1:** The TC77-3.3MXX and TC77-5.0MXX will operate from a supply voltage of 2.7V to 5.5V. However, the temperature accuracy of the TC77-3.3MXX and TC77-5.0MXX is specified at the nominal operating voltages of 3.3V and 5.0V, respectively. As  $V_{DD}$  varies from the nominal operating value, the accuracy may be degraded (Refer to Figures 2-6 and 2-7).

**2:** All time measurements are measured with respect to the 50% point of the signal.

**3:** Load Capacitance,  $C_L = 80 \text{ pF}$ , is used for AC timing measurements of output signals.

**4:** Resolution = Temperature Range/No. of Bits =  $(+255^{\circ}C - -256^{\circ}C) / (2^{13})$

Resolution =  $512/8192 = 0.0625^{\circ}C/Bit$

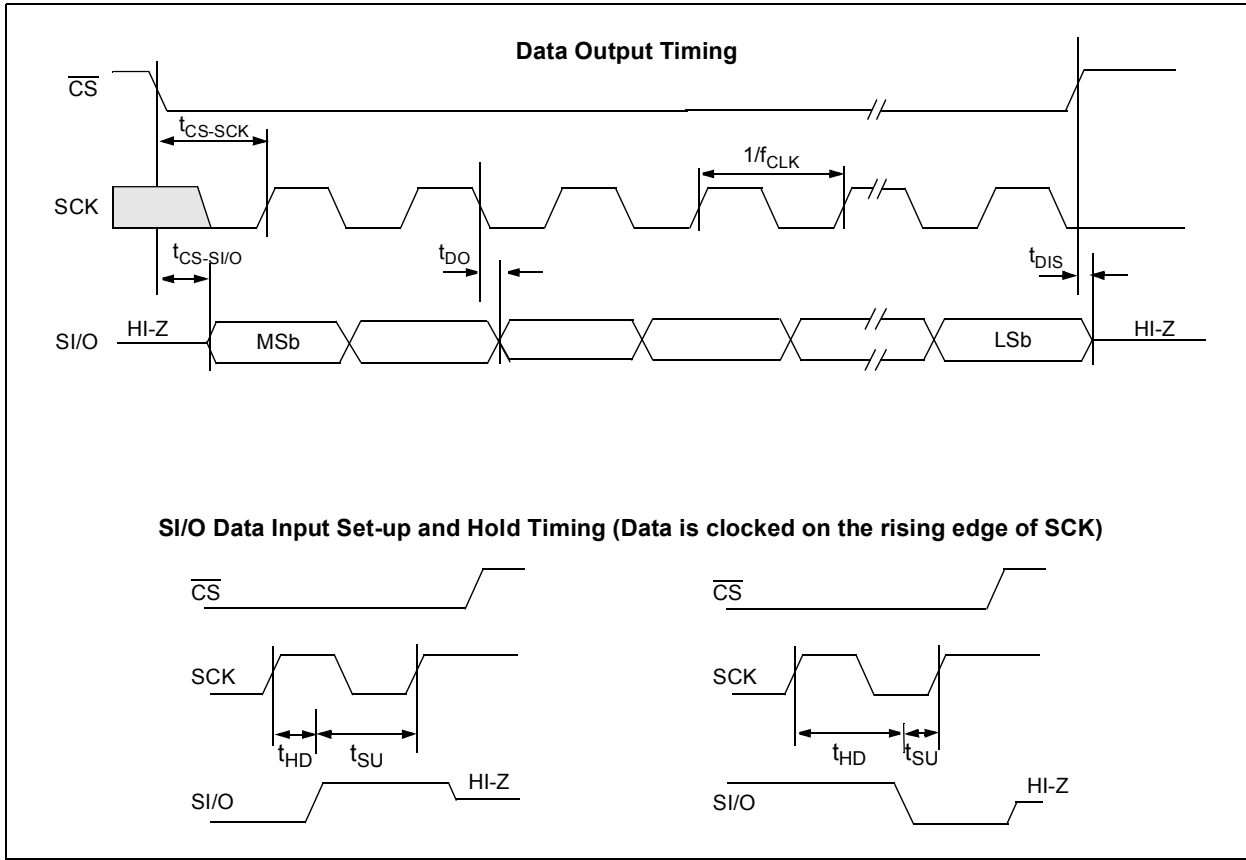
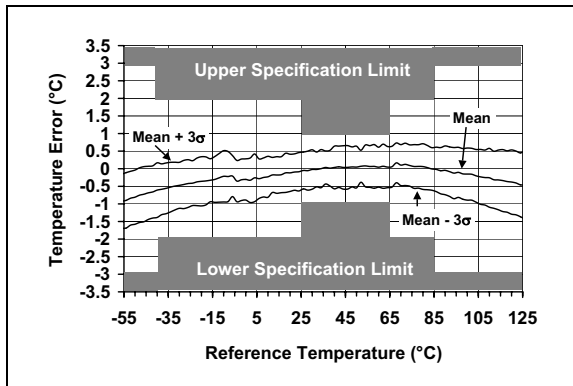

**FIGURE 1-1:** Timing Diagrams.

## 2.0 TYPICAL PERFORMANCE CURVES

**Note:** The graphs and tables provided following this note are a statistical summary based on a limited number of samples and are provided for informational purposes only. The performance characteristics listed herein are not tested or guaranteed. In some graphs or tables, the data presented may be outside the specified operating range (e.g., outside specified power supply range) and therefore outside the warranted range.

**Note:** Unless otherwise indicated, all parameters apply at  $V_{DD} = 3.3V$  for the TC77-3.3MXX and  $V_{DD} = 5.0V$  for the TC77-5.0MXX, and  $T_A = -55^{\circ}C$  to  $+125^{\circ}C$ . The TC77-3.3MXX and TC77-5.0MXX will operate from a supply voltage of 2.7V to 5.5V. However, the temperature accuracy of the TC77-3.3MXX and TC77-5.0MXX is specified at the nominal operating voltages of 3.3V and 5.0V, respectively.



**FIGURE 2-1:** Accuracy vs. Temperature (TC77-XXMXX).

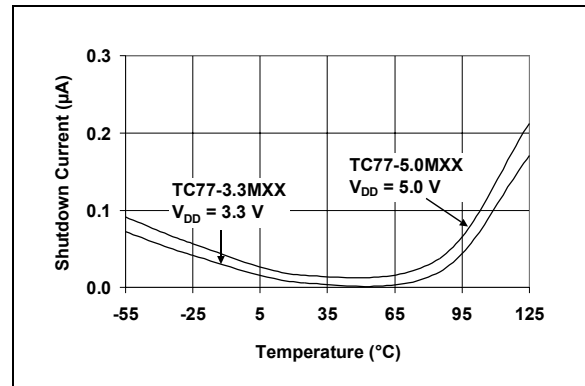

**FIGURE 2-4:** Shutdown Current vs. Temperature.

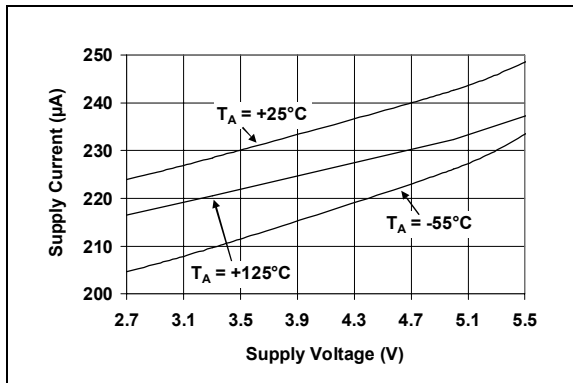

**FIGURE 2-2:** Supply Current vs. Supply Voltage (TC77-XXMXX).

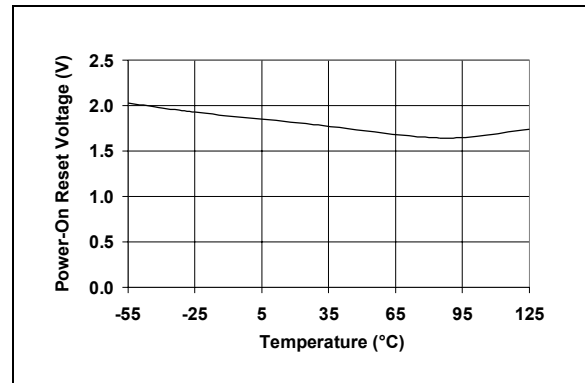

**FIGURE 2-5:** Power-On Reset Voltage vs. Temperature (TC77-XXMXX).

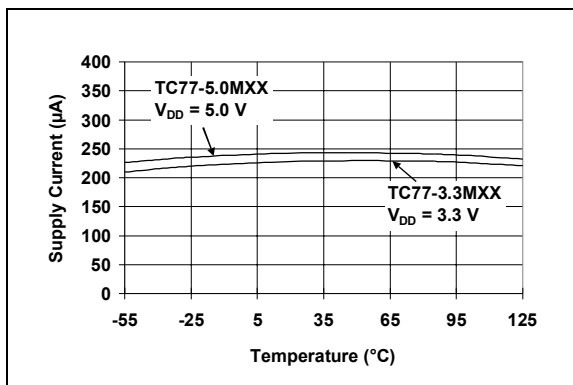

**FIGURE 2-3:** Supply Current vs. Temperature.

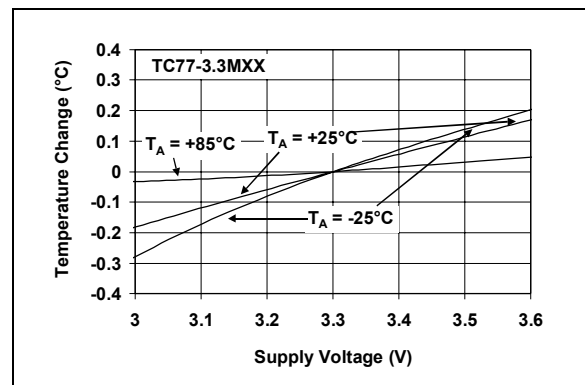

**FIGURE 2-6:** Temperature Accuracy vs. Supply Voltage (TC77-3.3MXX).

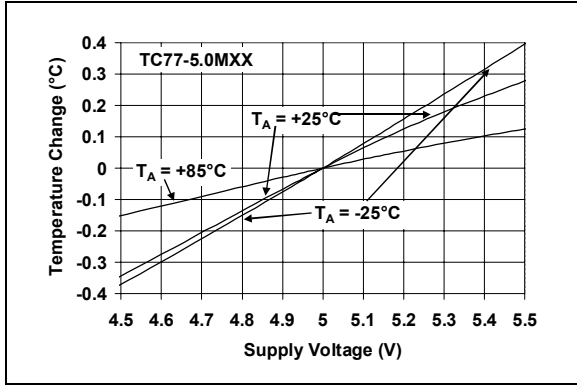

**FIGURE 2-7:** Temperature Accuracy vs. Supply Voltage (TC77-5.0MXX).

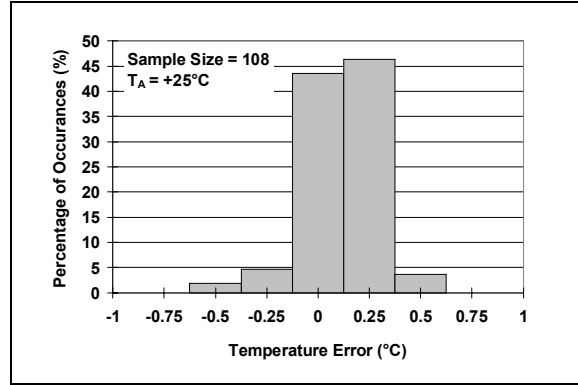

**FIGURE 2-10:** Histogram of Temperature Accuracy at +25 Degrees C (TC77-XXMXX).

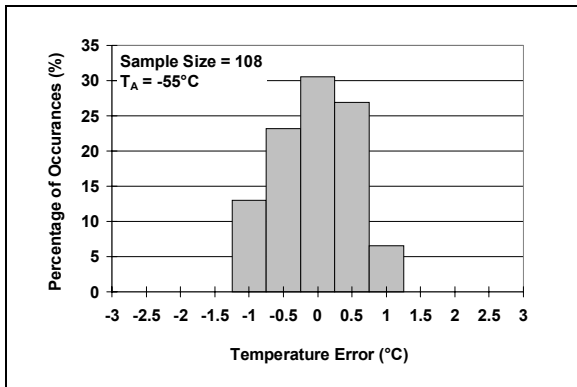

**FIGURE 2-8:** Histogram of Temperature Accuracy at -55 Degrees C (TC77-XXMXX).

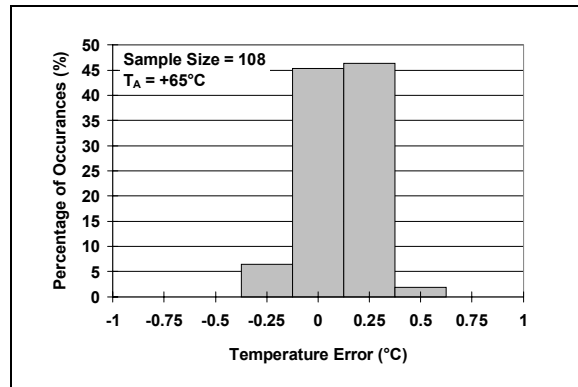

**FIGURE 2-11:** Histogram of Temperature Accuracy at +65 Degrees C (TC77-XXMXX).

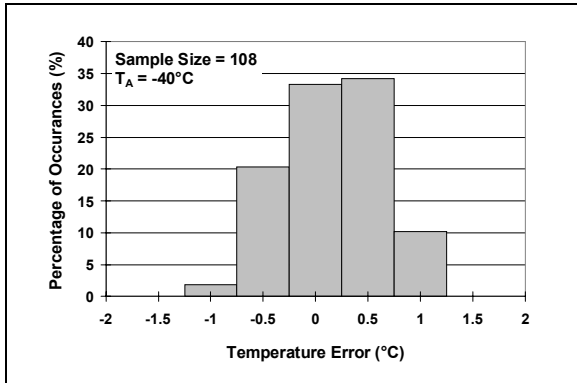

**FIGURE 2-9:** Histogram of Temperature Accuracy at -40 Degrees C (TC77-XXMXX).

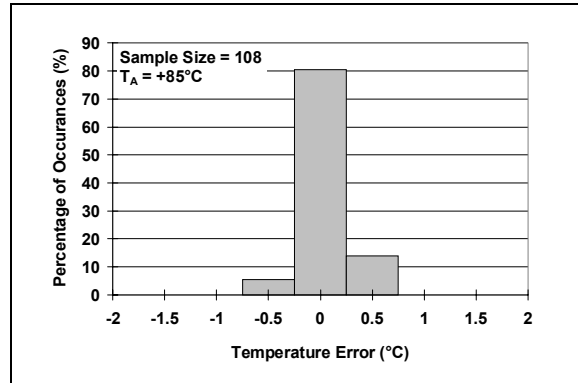

**FIGURE 2-12:** Histogram of Temperature Accuracy at +85 Degrees C (TC77-XXMXX).

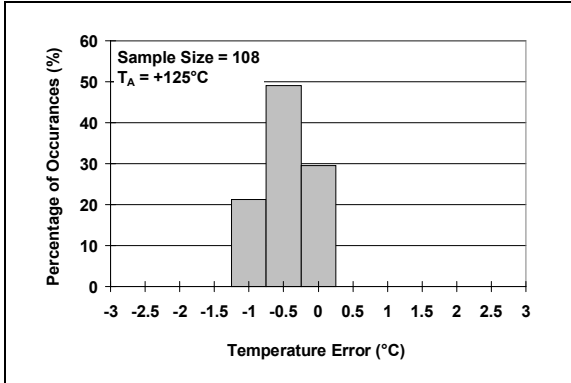
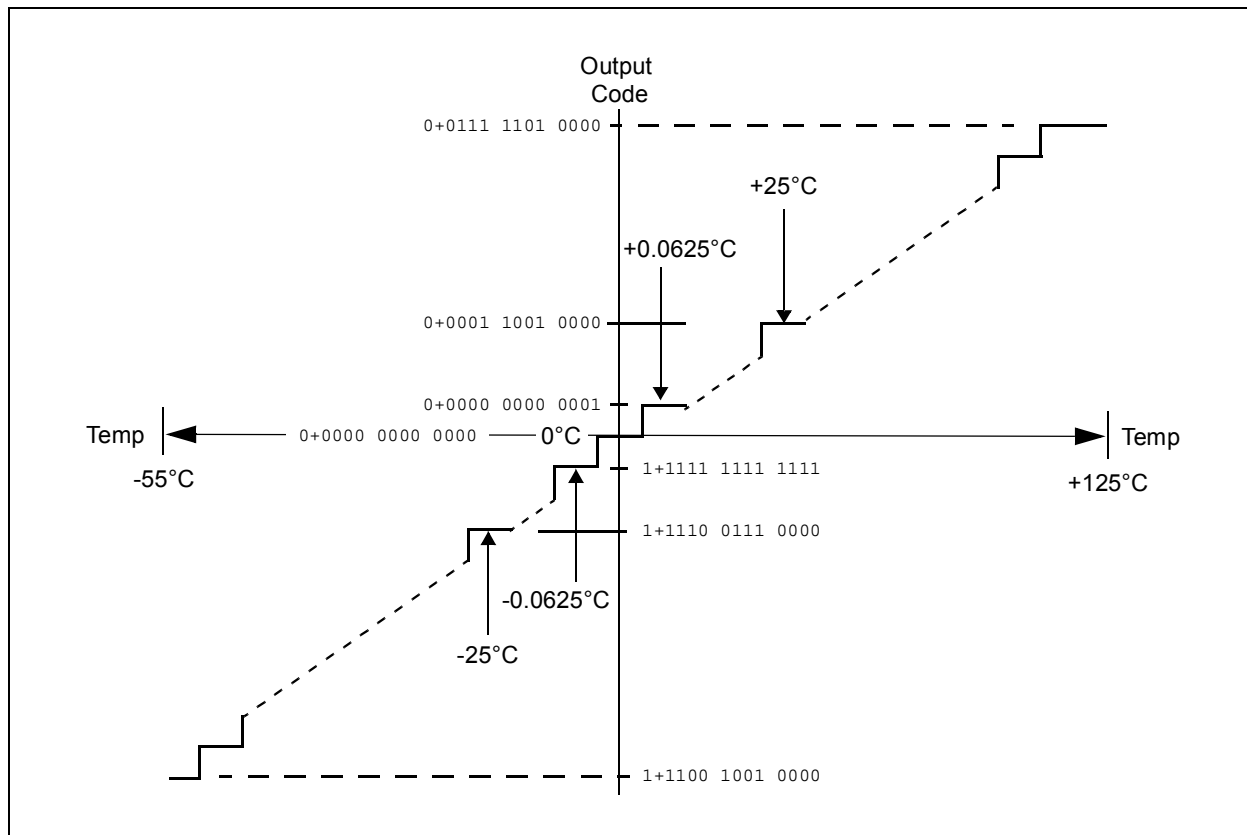

**FIGURE 2-13:** Histogram of Temperature Accuracy at +125 Degrees C (TC77-XXMXX).

# TC77

## 3.0 FUNCTIONAL DESCRIPTION

The TC77 consists of a band-gap type temperature sensor, a 12-bit plus sign (13-bit) Sigma-Delta Analog-to-Digital Converter (ADC), an internal conversion oscillator (~30 kHz) and a serial input/output port. These devices feature a three-wire serial interface that is fully compatible with SPI and MICROWIRE specifications and, therefore, allows simple communications with common microcontrollers and processors. The Shutdown mode can be used to reduce supply current for power sensitive applications. A Manufacturer's ID register identifies the TC77 as a Microchip Technology product.



**FIGURE 3-1:** Temperature To Digital Transfer Function (Non-linear Scale).



## 3.1 Temperature Data Format

A 13-bit two's complement digital word is used to represent the temperature. The Least Significant Bit (LSb) is equal to 0.0625°C. Note that the last two LSb bits (Bit 0 and 1) are tri-stated and are represented as a logic '1' in the table. Bit 2 is set to logic '1' after the completion of the first temperature conversion following a power-up or voltage reset event.

**TABLE 3-1: TC77 OUTPUT**

Temperature	Binary MSB / LSB	Hex
+125°C	0011 1110 1000 0111	3E 87h
+25°C	0000 1100 1000 0111	0B 87h
+0.0625°C	0000 0000 0000 1111	00 0Fh
0°C	0000 0000 0000 0111	00 07h
-0.0625°C	1111 1111 1111 1111	FF FFh
-25°C	1111 0011 1000 0111	F3 87h
-55°C	1110 0100 1000 0111	E4 87h

An over-temperature condition can be determined by reading only the first few Most Significant Bits (MSb) of the temperature data. For example, the microprocessor could read only the first four bits of the Temperature register in order to determine that an over-temperature condition exists.

## 3.2 Power-Up And Power-Down

The TC77 is in the Continuous Temperature Conversion mode at power-up. The first valid temperature conversion will be available approximately 300 ms (refer to "Temperature to Bits Converter" section listed in the DC characteristics table) after power-up. Bit 2 of the Temperature register is set to a logic '1' after the completion of the first temperature conversion following a power-up or voltage reset event. Bit 2 is set to logic '0' during the time needed to complete the first temperature conversion. Thus, the status of bit 2 can be monitored to indicate the completion of the first temperature conversion.

A supply voltage lower than 1.6V (typ.) is considered a power-down state for the TC77. The device will reset itself and continue its normal Continuous Conversion mode of operation when the supply voltage rises above the nominal 1.6V. A minimal supply voltage of 2.7V is required in order to ensure proper operation of the device.

## 3.3 Serial Bus Interface

The serial interface consists of the Chip Select ( $\overline{CS}$ ), Serial Clock (SCK) and Serial Data (SI/O) signals. The TC77 meets the SPI and MICROWIRE bus specifications, with the serial interface designed to be compatible with the Microchip PICmicro<sup>®</sup> family of microcontrollers.

The  $\overline{CS}$  input is used to select the TC77 when multiple devices are connected to the serial clock and data lines. The  $\overline{CS}$  line is also used to synchronize the data, which is written to, or read from, the device when  $\overline{CS}$  is equal to a logic '0' voltage. The SCK input is disabled when  $\overline{CS}$  is a logic '1'. The falling edge of the  $\overline{CS}$  line initiates communication, while the rising edge of  $\overline{CS}$  completes the communication.

The SCK input is provided by the external microcontroller and is used to synchronize the data on the SI/O line. The Temperature and Manufacturer ID registers are read only while the Configuration register is a read/write register.

Figure 3-2 provides a timing diagram of a read operation of the Temperature register. Communication with the TC77 is initiated when the  $\overline{CS}$  goes to a logic '0'. The Serial I/O signal (SI/O) then transmits the first bit of data. The microcontroller serial I/O bus master clocks the data in on the rising edge of SCK. The falling edge of SCK is then used to clock out the rest of the data. After 14 bits of data (thirteen temperature bits and Bit 2) have been transmitted, the SI/O line is then tri-stated.

Note that  $\overline{CS}$  can be taken to a logic '1' at any time during the data transmission if only a portion of the temperature data information is required. The TC77 will complete the conversion, and the output shift register will be updated, if  $\overline{CS}$  goes to the inactive state while in the middle of a conversion.

Figure 3-3 provides a timing diagram of a multi-byte communication operation consisting of a read of the Temperature Data register, followed by a write to the Configuration register. The first 16 SCK pulses are used to transmit the TC77's temperature data to the microcontroller. The second group of 16 SCK pulses are used to receive the microcontroller command to place the TC77 either in Shutdown or Continuous Temperature Conversion mode. Note that the TC77 is in the Continuous Temperature Conversion mode at power-up.

The data written to the TC77's Configuration register should be either all 0's or all 1's, corresponding to either the Continuous Temperature Conversion or Shutdown mode, respectively. The TC77 is in Shutdown mode when Bits C0 to C7 are all equal to 1's. The TC77 will be in the Continuous Conversion mode if a '0' in any bit location from C0 to C7 is written to the Configuration register.

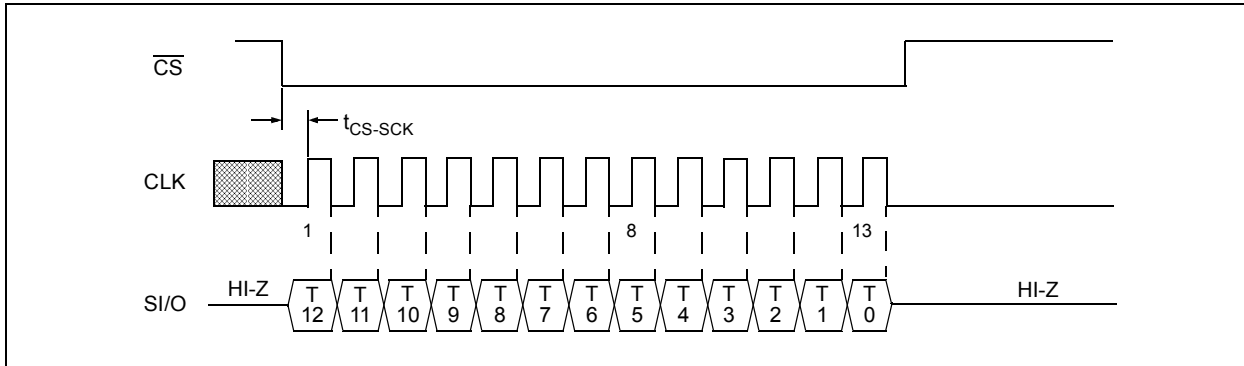

**FIGURE 3-2:** Temperature Read Timing Diagram - (Reading only the first 13 Bits of the Temperature Register).

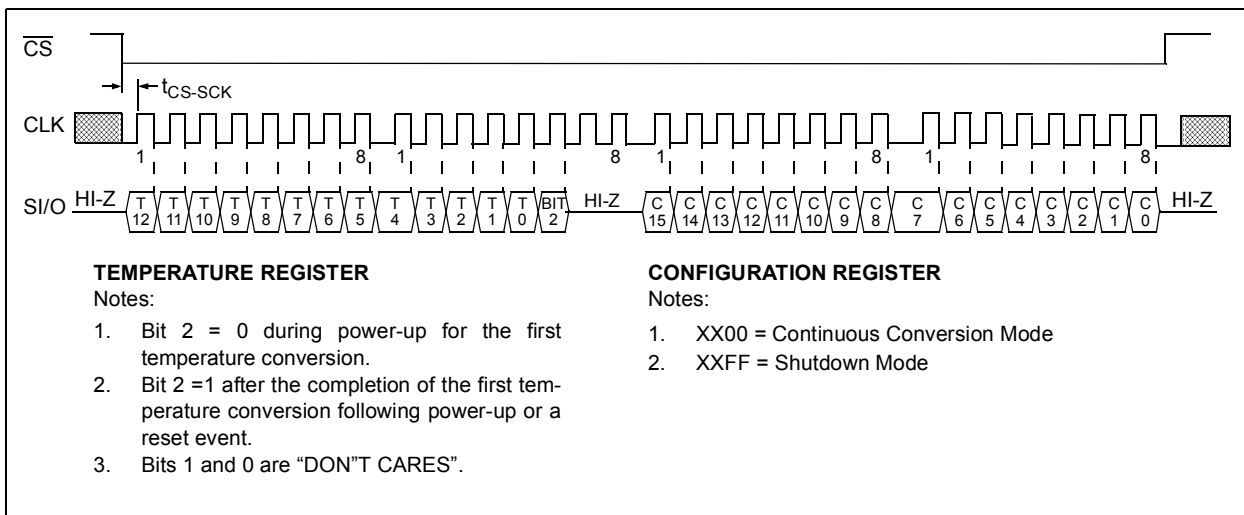

**FIGURE 3-3:** Temperature Read Followed By A Write To The Configuration Register Timing Diagram.

It is recommended that the user write all '0's or all '1's to the Configuration register. While the following codes can be transmitted to the TC77, any other code may put the TC77 into a test mode reserved by Microchip for calibration and production verification tests.

- 00 hex
- 01 hex
- 03 hex
- 07 hex
- 0F hex
- 1F hex
- 3F hex
- 7F hex
- FF hex

The following communication steps can be used to obtain the Manufacturer's ID and put the device into the Continuous Conversion mode. The Manufacturer's ID register is only accessible for a read operation, if the TC77 is in Shutdown mode.

1.  $\overline{CS}$  goes low to initiate the communication cycle.
2. Read 16 bits of temperature data from the Temperature register.
3. Write 16 bits of data (i.e. XXFF hex) to the Configuration register to enter Shutdown mode.
4. Read the 16 bits from the Manufacturer's ID register (C15:C8 = 54 hex) to verify that the sensor is a Microchip device.
5. Write 8 to 16 bits of data (00 or 0000 hex) to enter Continuous Conversion Mode.
6. Return  $\overline{CS}$  high to terminate the communication cycle.

The time between a complete temperature conversion and data transmission is approximately 300 msec.

## 4.0 INTERNAL REGISTER STRUCTURE

The TC77 Internal register structure consists of three registers. The Temperature and Manufacturer's Identification registers are read only, while the Configuration register is write only.

**TABLE 4-1: REGISTERS FOR TC77**

Name	Bit 15	Bit 14	Bit 13	Bit 12	Bit 11	Bit 10	Bit 9	Bit 8	Bit 7	Bit 6	Bit 5	Bit 4	Bit 3	Bit 2	Bit 1	Bit 0	Value at Powerup/Reset
CONFIG	C15	C14	C13	C12	C11	C10	C9	C8	C7	C6	C5	C4	C3	C2	C1	C0	XXXX/XXXX 0000/0000
TEMP	T12	T11	T10	T9	T8	T7	T6	T5	T4	T3	T2	T1	T0	*	x	x	1111/1111 0000/0*XX
M_ID	0	1	0	1	0	1	0	0	0	0	0	0	0	0	x	x	0101/0100 0000/00XX

\* Bit 2 = 0 during power-up; otherwise, bit 2 =1

### 4.1 Configuration Register (CONFIG)

The Configuration register is write only. This register selects either Shutdown, Continuous Conversion or Test modes:

- C15:C0 = XXXX/XXXX 1111/1111 (Shutdown mode)
- C15:C0 = XXXX/XXXX 0000/0000 (Continuous Conversion mode)
- The TC77 is in Shutdown mode when bits C0 to C7 are all equal to '1's. The TC77 will be in the Continuous Conversion mode if a '0' in any bit location from C0 to C7 is written to the Configuration register. The TC77 is in the Continuous Conversion mode at power-up.

It is recommended that the user write all '0's or all '1's to the Configuration register because other bit codes may put the TC77 in a test mode used for calibration and production verification tests. Section 3.3 lists the Configuration register bit codes that can be written to the TC77 without having the device enter a production test mode.

During Shutdown mode, the serial bus is still active. The current consumption of the TC77 will be less than 1  $\mu$ A during the time between serial communication.

### 4.2 Temperature Register (TEMP)

The Temperature register is read only and holds the temperature conversion data. Bits 0 and 1 are undefined and will be tri-state outputs during a read sequence. Bit 2 is set to a logic '1' after completion of the first temperature conversion following a power-up or reset event. Bit 2 is set to a logic '0' during the time needed to complete the first temperature conversion. Therefore, the status of bit 2 can be monitored to indicate that the TC77 has completed the first temperature conversion. Bits 15:3 contain the 13 bit two's complement data from the temperature conversion.

### 4.3 Manufacturer's ID Register (M\_ID)

The Manufacturer's Identification code is contained in this read only register. The Manufacturer ID register is only available for a read operation when the TC77 is in Shutdown mode. The Manufacturer's ID code is contained in bits 15:8 and is equal to 54 hex to indicate a Microchip device. Bits 1:0 are undefined and will be tri-state outputs during a read sequence, while bits 7:2 are set to '0'.

## 5.0 APPLICATION INFORMATION

The TC77 does not require any additional components in order to measure temperature. However, it is recommended that a decoupling capacitor of 0.1  $\mu\text{F}$  to 1  $\mu\text{F}$  be provided between the  $V_{\text{DD}}$  and  $V_{\text{SS}}$  (Ground) pins (a high frequency ceramic capacitor should be used). It is necessary for the capacitor to be located as close as possible to the integrated circuit (IC) power pins in order to provide effective noise protection to the TC77.

The TC77 measures temperature by monitoring the voltage of a diode located on the IC die. A low-impedance thermal path between the die and the printed circuit board (PCB) is provided by the IC pins of the TC77. Therefore, the TC77 effectively monitors the temperature of the PCB board. The thermal path between the ambient air is not as efficient because the plastic IC housing package functions as a thermal insulator. Thus, the ambient air temperature (assuming that a large temperature gradient exists between the air and PCB) has only a small effect on the temperature measured by the TC77.

A potential for self-heating errors can exist if the TC77 SPI communication lines are heavily loaded. Typically, the self-heating error is negligible because of the relatively small current consumption of the TC77. A temperature accuracy error of approximately 0.5°C will result from self-heating if the SPI communication pins sink/source the maximum current specified for the TC77. Therefore, to maximize the temperature accuracy, the output loading of the SPI signals should be minimized.

## 6.0 PACKAGING INFORMATION

### 6.1 Package Marking Information

5-Lead SOT-23

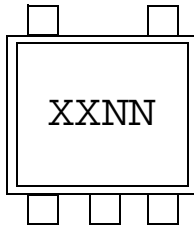

Example:

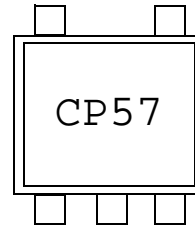

TC77-3.3MCTTR = CN  
TC77-5.0MCTTR = CP

8-Lead SOIC (150 mil)

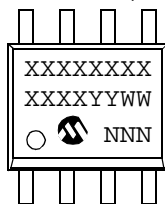

Example:

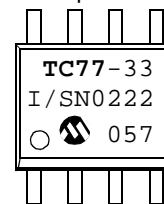

<b>Legend:</b>	XX...X	Customer specific information*
	Y	Year code (last digit of calendar year)
	YY	Year code (last 2 digits of calendar year)
	WW	Week code (week of January 1 is week '01')
	NNN	Alphanumeric traceability code
<b>Note:</b>	In the event the full Microchip part number cannot be marked on one line, it will be carried over to the next line thus limiting the number of available characters for customer specific information.	

\* Standard marking consists of Microchip part number, year code, week code, and traceability code. Please check with your Microchip Sales Office.

# TC77

## 5-Lead Plastic Small Outline Transistor (OT) (SOT23)

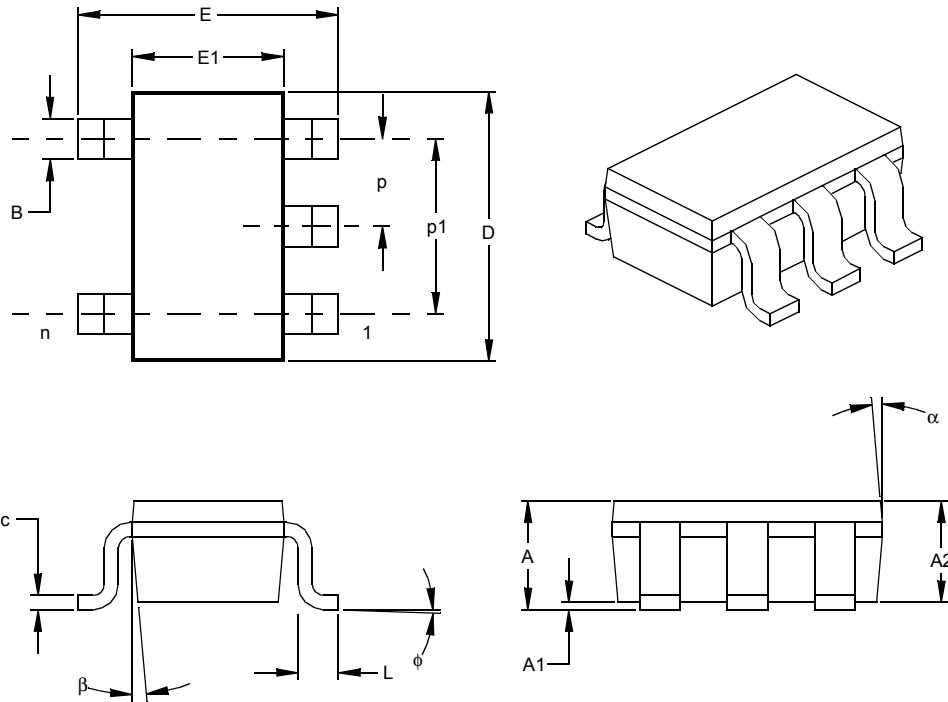

Units		INCHES*			MILLIMETERS		
Dimension Limits		MIN	NOM	MAX	MIN	NOM	MAX
Number of Pins	n		5			5	
Pitch	p		.038			0.95	
Outside lead pitch (basic)	p1		.075			1.90	
Overall Height	A	.035	.046	.057	0.90	1.18	1.45
Molded Package Thickness	A2	.035	.043	.051	0.90	1.10	1.30
Standoff §	A1	.000	.003	.006	0.00	0.08	0.15
Overall Width	E	.102	.110	.118	2.60	2.80	3.00
Molded Package Width	E1	.059	.064	.069	1.50	1.63	1.75
Overall Length	D	.110	.116	.122	2.80	2.95	3.10
Foot Length	L	.014	.018	.022	0.35	0.45	0.55
Foot Angle	φ	0	5	10	0	5	10
Lead Thickness	c	.004	.006	.008	0.09	0.15	0.20
Lead Width	B	.014	.017	.020	0.35	0.43	0.50
Mold Draft Angle Top	α	0	5	10	0	5	10
Mold Draft Angle Bottom	β	0	5	10	0	5	10

\* Controlling Parameter  
 § Significant Characteristic

Notes:  
 Dimensions D and E1 do not include mold flash or protrusions. Mold flash or protrusions shall not exceed .010" (0.254mm) per side.  
 JEDEC Equivalent: MO-178  
 Drawing No. C04-091

## 8-Lead Plastic Small Outline (SN) – Narrow, 150 mil (SOIC)

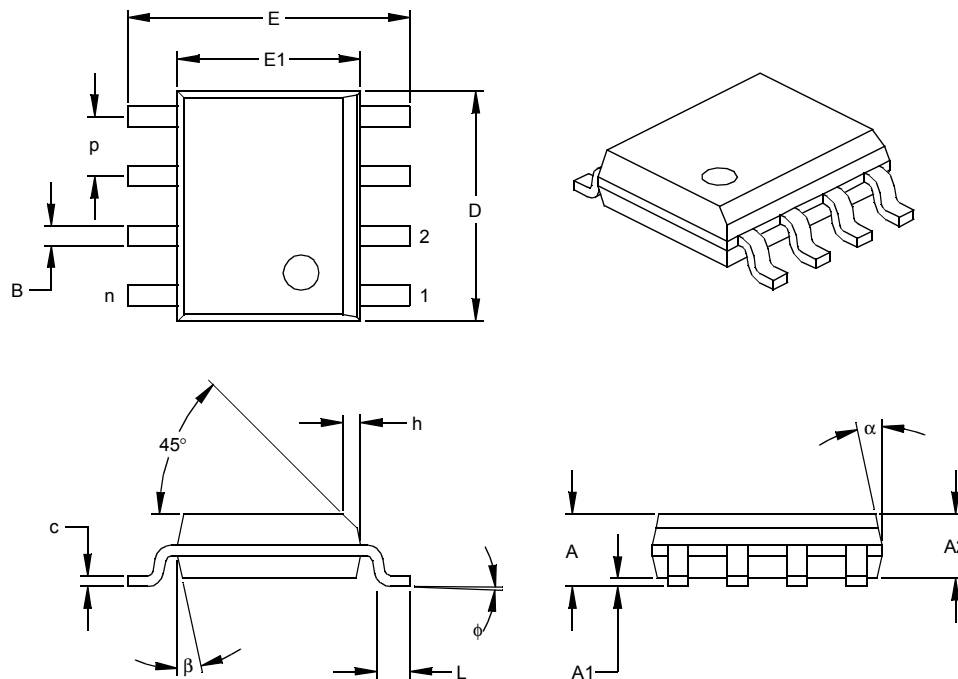

Dimension Limits	Units	INCHES*			MILLIMETERS		
		MIN	NOM	MAX	MIN	NOM	MAX
Number of Pins	n		8			8	
Pitch	p		.050			1.27	
Overall Height	A	.053	.061	.069	1.35	1.55	1.75
Molded Package Thickness	A2	.052	.056	.061	1.32	1.42	1.55
Standoff §	A1	.004	.007	.010	0.10	0.18	0.25
Overall Width	E	.228	.237	.244	5.79	6.02	6.20
Molded Package Width	E1	.146	.154	.157	3.71	3.91	3.99
Overall Length	D	.189	.193	.197	4.80	4.90	5.00
Chamfer Distance	h	.010	.015	.020	0.25	0.38	0.51
Foot Length	L	.019	.025	.030	0.48	0.62	0.76
Foot Angle	φ	0	4	8	0	4	8
Lead Thickness	c	.008	.009	.010	0.20	0.23	0.25
Lead Width	B	.013	.017	.020	0.33	0.42	0.51
Mold Draft Angle Top	α	0	12	15	0	12	15
Mold Draft Angle Bottom	β	0	12	15	0	12	15

\* Controlling Parameter  
 § Significant Characteristic

Notes:  
 Dimensions D and E1 do not include mold flash or protrusions. Mold flash or protrusions shall not exceed .010" (0.254mm) per side.  
 JEDEC Equivalent: MS-012  
 Drawing No. C04-057

# TC77

---

NOTES:



## ON-LINE SUPPORT

Microchip provides on-line support on the Microchip World Wide Web site.

The web site is used by Microchip as a means to make files and information easily available to customers. To view the site, the user must have access to the Internet and a web browser, such as Netscape® or Microsoft® Internet Explorer. Files are also available for FTP download from our FTP site.

### Connecting to the Microchip Internet Web Site

The Microchip web site is available at the following URL:

**[www.microchip.com](http://www.microchip.com)**

The file transfer site is available by using an FTP service to connect to:

**<ftp://ftp.microchip.com>**

The web site and file transfer site provide a variety of services. Users may download files for the latest Development Tools, Data Sheets, Application Notes, User's Guides, Articles and Sample Programs. A variety of Microchip specific business information is also available, including listings of Microchip sales offices, distributors and factory representatives. Other data available for consideration is:

- Latest Microchip Press Releases
- Technical Support Section with Frequently Asked Questions
- Design Tips
- Device Errata
- Job Postings
- Microchip Consultant Program Member Listing
- Links to other useful web sites related to Microchip Products
- Conferences for products, Development Systems, technical information and more
- Listing of seminars and events

## SYSTEMS INFORMATION AND UPGRADE HOT LINE

The Systems Information and Upgrade Line provides system users a listing of the latest versions of all of Microchip's development systems software products. Plus, this line provides information on how customers can receive the most current upgrade kits. The Hot Line Numbers are:

1-800-755-2345 for U.S. and most of Canada, and

1-480-792-7302 for the rest of the world.

092002





# TC77

---

NOTES:

---

Information contained in this publication regarding device applications and the like is intended through suggestion only and may be superseded by updates. It is your responsibility to ensure that your application meets with your specifications. No representation or warranty is given and no liability is assumed by Microchip Technology Incorporated with respect to the accuracy or use of such information, or infringement of patents or other intellectual property rights arising from such use or otherwise. Use of Microchip's products as critical components in life support systems is not authorized except with express written approval by Microchip. No licenses are conveyed, implicitly or otherwise, under any intellectual property rights.

#### Trademarks

The Microchip name and logo, the Microchip logo, KEELOQ, MPLAB, PIC, PICmicro, PICSTART and PRO MATE are registered trademarks of Microchip Technology Incorporated in the U.S.A. and other countries.

FilterLab, microID, MXDEV, MXLAB, PICMASTER, SEEVAL and The Embedded Control Solutions Company are registered trademarks of Microchip Technology Incorporated in the U.S.A.

dsPIC, dsPICDEM.net, ECONOMONITOR, FanSense, FlexROM, fuzzyLAB, In-Circuit Serial Programming, ICSP, ICEPIC, microPort, Migratable Memory, MPASM, MPLIB, MPLINK, MPSIM, PICC, PICDEM, PICDEM.net, rPIC, Select Mode and Total Endurance are trademarks of Microchip Technology Incorporated in the U.S.A. and other countries.

Serialized Quick Turn Programming (SQTP) is a service mark of Microchip Technology Incorporated in the U.S.A.

All other trademarks mentioned herein are property of their respective companies.

© 2002, Microchip Technology Incorporated, Printed in the U.S.A., All Rights Reserved.

 Printed on recycled paper.

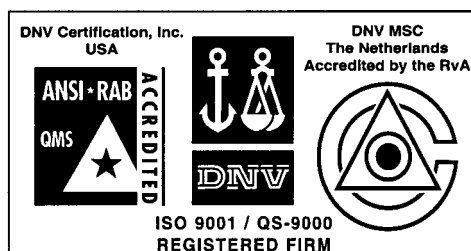

*Microchip received QS-9000 quality system certification for its worldwide headquarters, design and wafer fabrication facilities in Chandler and Tempe, Arizona in July 1999 and Mountain View, California in March 2002. The Company's quality system processes and procedures are QS-9000 compliant for its PICmicro® 8-bit MCUs, KEELOQ® code hopping devices, Serial EEPROMs, microperipherals, non-volatile memory and analog products. In addition, Microchip's quality system for the design and manufacture of development systems is ISO 9001 certified.*



# MICROCHIP

## WORLDWIDE SALES AND SERVICE

### AMERICAS

#### Corporate Office

2355 West Chandler Blvd.  
Chandler, AZ 85224-6199  
Tel: 480-792-7200 Fax: 480-792-7277  
Technical Support: 480-792-7627  
Web Address: <http://www.microchip.com>

#### Rocky Mountain

2355 West Chandler Blvd.  
Chandler, AZ 85224-6199  
Tel: 480-692-7966 Fax: 480-792-4338

#### Atlanta

500 Sugar Mill Road, Suite 200B  
Atlanta, GA 30350  
Tel: 770-640-0034 Fax: 770-640-0307

#### Boston

2 Lan Drive, Suite 120  
Westford, MA 01886  
Tel: 978-692-3848 Fax: 978-692-3821

#### Chicago

333 Pierce Road, Suite 180  
Itasca, IL 60143  
Tel: 630-285-0071 Fax: 630-285-0075

#### Dallas

4570 Westgrove Drive, Suite 160  
Addison, TX 75001  
Tel: 972-818-7423 Fax: 972-818-2924

#### Detroit

Tri-Atria Office Building  
32255 Northwestern Highway, Suite 190  
Farmington Hills, MI 48334  
Tel: 248-538-2250 Fax: 248-538-2260

#### Kokomo

2767 S. Albright Road  
Kokomo, Indiana 46902  
Tel: 765-864-8360 Fax: 765-864-8387

#### Los Angeles

18201 Von Karman, Suite 1090  
Irvine, CA 92612  
Tel: 949-263-1888 Fax: 949-263-1338

#### New York

150 Motor Parkway, Suite 202  
Hauppauge, NY 11788  
Tel: 631-273-5305 Fax: 631-273-5335

#### San Jose

Microchip Technology Inc.  
2107 North First Street, Suite 590  
San Jose, CA 95131  
Tel: 408-436-7950 Fax: 408-436-7955

#### Toronto

6285 Northam Drive, Suite 108  
Mississauga, Ontario L4V 1X5, Canada  
Tel: 905-673-0699 Fax: 905-673-6509

### ASIA/PACIFIC

#### Australia

Microchip Technology Australia Pty Ltd  
Suite 22, 41 Rawson Street  
Epping 2121, NSW  
Australia  
Tel: 61-2-9868-6733 Fax: 61-2-9868-6755

#### China - Beijing

Microchip Technology Consulting (Shanghai)  
Co., Ltd., Beijing Liaison Office  
Unit 915  
Bei Hai Wan Tai Bldg.  
No. 6 Chaoyangmen Beidajie  
Beijing, 100027, No. China  
Tel: 86-10-85282100 Fax: 86-10-85282104

#### China - Chengdu

Microchip Technology Consulting (Shanghai)  
Co., Ltd., Chengdu Liaison Office  
Rm. 2401, 24th Floor,  
Ming Xing Financial Tower  
No. 88 TIDU Street  
Chengdu 610016, China  
Tel: 86-28-86766200 Fax: 86-28-86766599

#### China - Fuzhou

Microchip Technology Consulting (Shanghai)  
Co., Ltd., Fuzhou Liaison Office  
Unit 28F, World Trade Plaza  
No. 71 Wusi Road  
Fuzhou 350001, China  
Tel: 86-591-7503506 Fax: 86-591-7503521

#### China - Shanghai

Microchip Technology Consulting (Shanghai)  
Co., Ltd.  
Room 701, Bldg. B  
Far East International Plaza  
No. 317 Xian Xia Road  
Shanghai, 200051  
Tel: 86-21-6275-5700 Fax: 86-21-6275-5060

#### China - Shenzhen

Microchip Technology Consulting (Shanghai)  
Co., Ltd., Shenzhen Liaison Office  
Rm. 1315, 13/F, Shenzhen Kerry Centre,  
Renminnan Lu  
Shenzhen 518001, China  
Tel: 86-755-2350361 Fax: 86-755-2366086

#### China - Hong Kong SAR

Microchip Technology Hongkong Ltd.  
Unit 901-6, Tower 2, Metroplaza  
223 Hing Fong Road  
Kwai Fong, N.T., Hong Kong  
Tel: 852-2401-1200 Fax: 852-2401-3431

#### India

Microchip Technology Inc.  
India Liaison Office  
Divyasree Chambers  
1 Floor, Wing A (A3/A4)  
No. 11, O'Shaughnessey Road  
Bangalore, 560 025, India  
Tel: 91-80-2290061 Fax: 91-80-2290062

### Japan

Microchip Technology Japan K.K.  
Benex S-1 6F  
3-18-20, Shinyokohama  
Kohoku-Ku, Yokohama-shi  
Kanagawa, 222-0033, Japan  
Tel: 81-45-471-6166 Fax: 81-45-471-6122

### Korea

Microchip Technology Korea  
168-1, Youngbo Bldg. 3 Floor  
Samsung-Dong, Kangnam-Ku  
Seoul, Korea 135-882  
Tel: 82-2-554-7200 Fax: 82-2-558-5934

### Singapore

Microchip Technology Singapore Pte Ltd.  
200 Middle Road  
#07-02 Prime Centre  
Singapore, 188980  
Tel: 65-6334-8870 Fax: 65-6334-8850

### Taiwan

Microchip Technology (Barbados) Inc.,  
Taiwan Branch  
11F-3, No. 207  
Tung Hua North Road  
Taipei, 105, Taiwan  
Tel: 886-2-2717-7175 Fax: 886-2-2545-0139

### EUROPE

#### Austria

Microchip Technology Austria GmbH  
Durisolstrasse 2  
A-4600 Wels  
Austria  
Tel: 43-7242-2244-399  
Fax: 43-7242-2244-393

#### Denmark

Microchip Technology Nordic ApS  
Regus Business Centre  
Lautrup høj 1-3  
Ballerup DK-2750 Denmark  
Tel: 45 4420 9895 Fax: 45 4420 9910

#### France

Microchip Technology SARL  
Parc d'Activite du Moulin de Massy  
43 Rue du Saule Trapu  
Batiment A - 1er Etage  
91300 Massy, France  
Tel: 33-1-69-53-63-20 Fax: 33-1-69-30-90-79

#### Germany

Microchip Technology GmbH  
Steinheilstrasse 10  
D-85737 Ismaning, Germany  
Tel: 49-89-627-144 0 Fax: 49-89-627-144-44

#### Italy

Microchip Technology SRL  
Centro Direzionale Colleoni  
Palazzo Taurus 1 V. Le Colleoni 1  
20041 Agrate Brianza  
Milan, Italy  
Tel: 39-039-65791-1 Fax: 39-039-6899883

#### United Kingdom

Microchip Ltd.  
505 Eskdale Road  
Winnersh Triangle  
Wokingham  
Berkshire, England RG41 5TU  
Tel: 44 118 921 5869 Fax: 44-118 921-5820

08/01/02

# Mouser Electronics

Authorized Distributor

Click to View Pricing, Inventory, Delivery & Lifecycle Information:

[Microchip:](#)

[TC77-3.3MOA](#) [TC77-5.0MOA](#) [TC77-5.0MOATR](#) [TC77-3.3MCTTR](#) [TC77-3.3MOATR](#) [TC77-5.0MCTTR](#) [TC77-5.0MCTTR-VAO](#)