

# CMOS, Rail-to-Rail, I/O OPERATIONAL AMPLIFIERS

## FEATURES

- RAIL-TO-RAIL INPUT AND OUTPUT
- WIDE SUPPLY RANGE:  
Single Supply: 4V to 12V  
Dual Supplies:  $\pm 2$  to  $\pm 6$
- LOW QUIESCENT CURRENT: 160 $\mu$ A
- FULL-SCALE CMRR: 90dB
- LOW OFFSET: 160 $\mu$ V
- HIGH SPEED:  
OPA703: 1MHz, 0.6V/ $\mu$ s  
OPA704: 3MHz, 3V/ $\mu$ s
- *Micro*SIZE PACKAGES:  
SOT23-5, MSOP-8, TSSOP-14
- LOW INPUT BIAS CURRENT: 1pA

## APPLICATIONS

- AUTOMOTIVE APPLICATIONS:  
Audio, Sensor Applications, Security Systems
- PORTABLE EQUIPMENT
- ACTIVE FILTERS
- TRANSDUCER AMPLIFIER
- TEST EQUIPMENT
- DATA ACQUISITION

## DESCRIPTION

The OPA703 and OPA704 series op amps are optimized for applications requiring rail-to-rail input and output swing. Single, dual, and quad versions are offered in a variety of packages. While the quiescent current is less than 200 $\mu$ A per amplifier, the OPA703 still offers excellent dynamic performance (1MHz GBW and 0.6V/ $\mu$ s SR) and unity-gain stability. The OPA704 is optimized for gains of 5 or greater and provides 3MHz GBW and 3V/ $\mu$ s slew rate.

The OPA703 and OPA704 series are fully specified and guaranteed over the supply range of  $\pm 2$ V to  $\pm 6$ V. Input swing extends 300mV beyond the rail and the output swings to within 40mV of the rail.

The single versions (OPA703 and OPA704) are available in the *Micro*SIZE SOT23-5 and in the standard SO-8 surface-mount, as well as the DIP-8 packages. Dual versions (OPA2703 and OPA2704) are available in the MSOP-8, SO-8, and DIP-8 packages. The quad OPA4703 and OPA4704 are available in the TSSOP-14 and SO-14 packages. All are specified for operation from  $-40^{\circ}$ C to  $+85^{\circ}$ C.

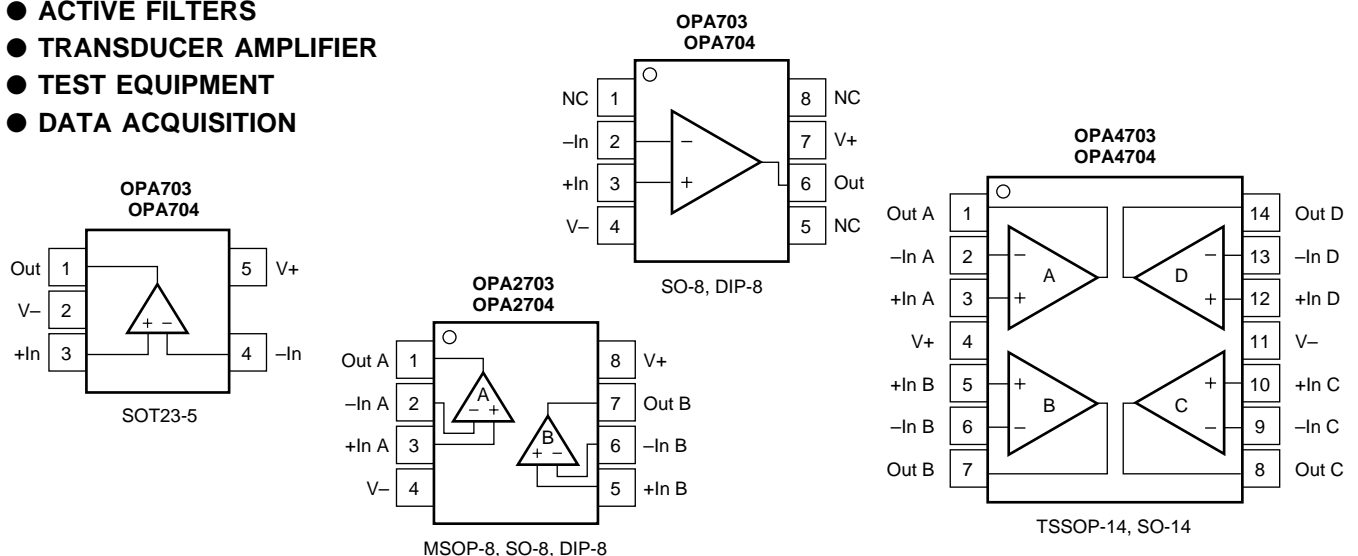

Please be aware that an important notice concerning availability, standard warranty, and use in critical applications of Texas Instruments semiconductor products and disclaimers thereto appears at the end of this data sheet.

## ABSOLUTE MAXIMUM RATINGS<sup>(1)</sup>

Supply Voltage, V+ to V-.....	13.2V
Signal Input Terminals, Voltage <sup>(2)</sup> ..... (V-) -0.3V to (V+) +0.3V	
Current <sup>(2)</sup> .....	10mA
Output Short-Circuit <sup>(3)</sup> .....	Continuous
Operating Temperature.....	-55°C to +125°C
Storage Temperature.....	-65°C to +150°C
Junction Temperature.....	+150°C
Lead Temperature (soldering, 10s).....	+300°C

NOTES: (1) Stresses above these ratings may cause permanent damage. Exposure to absolute maximum conditions for extended periods may degrade device reliability. (2) Input terminals are diode-clamped to the power supply rails. Input signals that can swing more than 0.3V beyond the supply rails should be current-limited to 10mA or less. (3) Short-circuit to ground, one amplifier per package.



## ELECTROSTATIC DISCHARGE SENSITIVITY

This integrated circuit can be damaged by ESD. Texas Instruments recommends that all integrated circuits be handled with appropriate precautions. Failure to observe proper handling and installation procedures can cause damage.

ESD damage can range from subtle performance degradation to complete device failure. Precision integrated circuits may be more susceptible to damage because very small parametric changes could cause the device not to meet its published specifications.

## PACKAGE/ORDERING INFORMATION

PRODUCT	DESCRIPTION	MINIMUM RECOMMENDED GAIN	PACKAGE	PACKAGE DRAWING NUMBER	PACKAGE MARKING	ORDERING NUMBER <sup>(1)</sup>	TRANSPORT MEDIA
OPA703NA "	Single, GBW = 1MHz "	1 "	SOT23-5 "	331 "	A03 "	OPA703NA/250 OPA703NA/3K	Tape and Reel Tape and Reel
OPA703UA "	Single, GBW = 1MHz "	1 "	SO-8 "	182 "	OPA703UA "	OPA703UA OPA703UA/2K5	Rails Tape and Reel
OPA703PA "	Single, GBW = 1MHz "	1 "	DIP-8 "	006 "	OPA703PA "	OPA703PA "	Rails Rails
OPA2703EA "	Dual, GBW = 1MHz "	1 "	MSOP-8 "	337 "	B03 "	OPA2703EA/250 OPA2703EA/2K5	Tape and Reel Tape and Reel
OPA2703UA "	Dual, GBW = 1MHz "	1 "	SO-8 "	182 "	OPA2703UA "	OPA2703UA OPA2703UA/2K5	Rails Tape and Reel
OPA2703PA "	Dual, GBW = 1MHz "	1 "	DIP-8 "	006 "	OPA2703PA "	OPA2703PA "	Rails Rails
OPA4703EA "	Quad, GBW = 1MHz "	1 "	TSSOP-14 "	357 "	OPA4703EA "	OPA4703EA/250 OPA4703EA/2K5	Tape and Reel Tape and Reel
OPA4703UA "	Quad, GBW = 1MHz "	1 "	SO-14 "	235 "	OPA4703UA "	OPA4703UA OPA4703UA/2K5	Rails Tape and Reel
OPA704NA "	Single, GBW = 5MHz "	5 "	SOT23-5 "	331 "	A04 "	OPA704NA/250 OPA704NA/3K	Tape and Reel Tape and Reel
OPA704UA "	Single, GBW = 5MHz "	5 "	SO-8 "	182 "	OPA704UA "	OPA704UA OPA704UA/2K5	Tape and Reel Tape and Reel
OPA704PA "	Single, GBW = 5MHz "	5 "	DIP-8 "	006 "	OPA704PA "	OPA704PA "	Rails Rails
OPA2704EA "	Dual, GBW = 5MHz "	5 "	MSOP-8 "	337 "	B04 "	OPA2703EA/250 OPA2703EA/2K5	Tape and Reel Tape and Reel
OPA2704UA "	Dual, GBW = 5MHz "	5 "	SO-8 "	182 "	OPA2704UA "	OPA2704UA OPA2704UA/2K5	Rails Tape and Reel
OPA2704PA "	Dual, GBW = 5MHz "	5 "	DIP-8 "	006 "	OPA2704PA "	OPA2704PA "	Rails Rails
OPA4704EA "	Quad, GBW = 5MHz "	5 "	TSSOP-14 "	357 "	OPA4704EA "	OPA4704EA/250 OPA4704EA/2K5	Tape and Reel Tape and Reel
OPA4704UA "	Quad, GBW = 5MHz "	5 "	SO-14 "	235 "	OPA4704UA "	OPA4704UA OPA4704UA/2K5	Rails Tape and Reel

NOTE: (1) Models with a slash (/) are available only in Tape and Reel in the quantities indicated (e.g., /3K indicates 3000 devices per reel). Ordering 3000 pieces of "OPA703NA/3K" will get a single 3000-piece Tape and Reel.

# OPA703 ELECTRICAL CHARACTERISTICS: $V_S = 4V$ to $12V$

**Boldface** limits apply over the specified temperature range,  $T_A = -40^{\circ}C$  to  $+85^{\circ}C$

At  $T_A = +25^{\circ}C$ ,  $R_L = 20k\Omega$  connected to  $V_S/2$  and  $V_{OUT} = V_S/2$ , unless otherwise noted.

PARAMETER	CONDITION	OPA703NA, UA, PA OPA2703EA, UA, PA OPA4703EA, UA			UNITS
		MIN	TYP	MAX	
<b>OFFSET VOLTAGE</b> Input Offset Voltage <b>Drift</b> vs Power Supply <b>Over Temperature</b> Channel Separation, dc $f = 1kHz$	$V_{OS}$ $dV_{OS}/dT$ PSRR $V_S = \pm 5V, V_{CM} = 0V$ $T_A = -40^{\circ}C$ to $+85^{\circ}C$ $V_S = \pm 2V$ to $\pm 6V, V_{CM} = 0V$ $V_S = \pm 2V$ to $\pm 6V, V_{CM} = 0V$ $R_L = 20k\Omega$		$\pm 160$ $\pm 4$ 20 1 98	$\pm 750$  100 <b>200</b>	$\mu V$ $\mu V/^{\circ}C$ $\mu V/V$ $\mu V/V$ $\mu V/V$ dB
<b>INPUT VOLTAGE RANGE</b> Common-Mode Voltage Range Common-Mode Rejection Ratio <b>over Temperature</b> <b>over Temperature</b>	$V_{CM}$ CMRR $V_S = \pm 5V, (V-) - 0.3V < V_{CM} < (V+) + 0.3V$ $V_S = \pm 5V, (V-) < V_{CM} < (V+)$ $V_S = \pm 5V, (V-) - 0.3V < V_{CM} < (V+) - 2V$ $V_S = \pm 5V, (V-) < V_{CM} < (V+) - 2V$	$(V-) - 0.3$ 70 80 74	90 96	$(V+) + 0.3$  dB dB dB	V dB dB dB
<b>INPUT BIAS CURRENT</b> Input Bias Current Input Offset Current	$I_B$ $I_{OS}$ $V_S = \pm 5V, V_{CM} = 0V$ $V_S = \pm 5V, V_{CM} = 0V$		$\pm 1$ $\pm 0.5$	$\pm 10$ $\pm 10$	pA pA
<b>INPUT IMPEDANCE</b> Differential Common-Mode			$4 \cdot 10^9 \parallel 4$ $5 \cdot 10^{12} \parallel 4$		$\Omega \parallel pF$ $\Omega \parallel pF$
<b>NOISE</b> Input Voltage Noise, $f = 0.1Hz$ to $10Hz$ Input Voltage Noise Density, $f = 1kHz$ Current Noise Density, $f = 1kHz$	$e_n$ $i_n$ $V_S = \pm 5V, V_{CM} = 0V$ $V_S = \pm 5V, V_{CM} = 0V$ $V_S = \pm 5V, V_{CM} = 0V$		6 45 2.5		$\mu Vp-p$ $nV/\sqrt{Hz}$ $fA/\sqrt{Hz}$
<b>OPEN-LOOP GAIN</b> Open-Loop Voltage Gain <b>over Temperature</b> <b>over Temperature</b>	$A_{OL}$ $R_L = 100k\Omega, (V-)+0.1V < V_O < (V+)-0.1V$ $R_L = 20k\Omega, (V-)+0.075V < V_O < (V+)-0.075V$ <b><math>R_L = 20k\Omega, (V-)+0.075V &lt; V_O &lt; (V+)-0.075V</math></b> $R_L = 5k\Omega, (V-)+0.15V < V_O < (V+)-0.15V$ <b><math>R_L = 5k\Omega, (V-)+0.15V &lt; V_O &lt; (V+)-0.15V</math></b>	100 <b>96</b> 100 <b>96</b>	120 110 110		dB dB dB dB
<b>OUTPUT</b> Voltage Output Swing from Rail <b>over Temperature</b> <b>over Temperature</b> Output Current Short-Circuit Current Capacitive Load Drive	$I_{OUT}$ $I_{SC}$ $C_{LOAD}$ $R_L = 100k\Omega, A_{OL} > 80dB$ $R_L = 20k\Omega, A_{OL} > 100dB$ <b><math>R_L = 20k\Omega, A_{OL} &gt; 96dB</math></b> $R_L = 5k\Omega, A_{OL} > 100dB$ <b><math>R_L = 5k\Omega, A_{OL} &gt; 96dB</math></b> $ V_S - V_{OUT}  < 1V$		40  $\pm 10$ $\pm 40$	75 <b>75</b> 150 <b>150</b>	mV mV <b>mV</b> mV <b>mV</b> mA mA
<b>FREQUENCY RESPONSE</b> Gain-Bandwidth Product Slew Rate Settling Time, 0.1% 0.01% Overload Recovery Time Total Harmonic Distortion + Noise	GBW SR $t_s$ THD+N $C_L = 100pF$ $G = +1$ $V_S = \pm 5V, G = +1$ $V_S = \pm 5V, 5V$ Step, $G = +1$ $V_S = \pm 5V, 5V$ Step, $G = +1$ $V_{IN} \cdot \text{Gain} = V_S$ $V_S = \pm 5V, V_O = 3Vp-p, G = +1, f = 1kHz$		1 0.6 15 20 3 0.02		MHz V/ $\mu s$ $\mu s$ $\mu s$ $\mu s$ %
<b>POWER SUPPLY</b> Specified Voltage Range, Single Supply Specified Voltage Range, Dual Supplies Operating Voltage Range Quiescent Current (per amplifier) <b>over Temperature</b>	$V_S$ $V_S$ $I_Q$ $I_Q = 0$	4 $\pm 2$	3.6 to 12 160	12 $\pm 6$	V V V $\mu A$ $\mu A$
<b>TEMPERATURE RANGE</b> Specified Range Operating Range Storage Range Thermal Resistance SOT23-5 Surface-Mount MSOP-8 Surface-Mount TSSOP-14 Surface-Mount SO-8 Surface Mount SO-14 Surface Mount DIP-8	$\theta_{JA}$	-40 -55 -65		85 125 150	$^{\circ}C$ $^{\circ}C$ $^{\circ}C$ $^{\circ}C/W$ $^{\circ}C/W$ $^{\circ}C/W$ $^{\circ}C/W$ $^{\circ}C/W$ $^{\circ}C/W$ $^{\circ}C/W$

# OPA704 ELECTRICAL CHARACTERISTICS: $V_S = 4V$ to $12V$

**Boldface** limits apply over the specified temperature range,  $T_A = -40^{\circ}C$  to  $+85^{\circ}C$

At  $T_A = +25^{\circ}C$ ,  $R_L = 20k\Omega$  connected to  $V_S/2$  and  $V_{OUT} = V_S/2$ , unless otherwise noted.

PARAMETER	CONDITION	OPA704NA, UA, PA OPA2704EA, UA, PA OPA4704EA, UA			UNITS
		MIN	TYP	MAX	
<b>OFFSET VOLTAGE</b> Input Offset Voltage <b>Drift</b> vs Power Supply <b>Over Temperature</b> Channel Separation, dc $f = 1kHz$	$V_{OS}$ $dV_{OS}/dT$ PSRR $V_S = \pm 5V, V_{CM} = 0V$ $T_A = -40^{\circ}C$ to $+85^{\circ}C$ $V_S = \pm 2V$ to $\pm 6V, V_{CM} = 0V$ $V_S = \pm 2V$ to $\pm 6V, V_{CM} = 0V$ $R_L = 20k\Omega$		$\pm 160$ $\pm 4$ 20 1 98	$\pm 750$  100 <b>200</b>	$\mu V$ $\mu V/^{\circ}C$ $\mu V/V$ $\mu V/V$ $\mu V/V$ dB
<b>INPUT VOLTAGE RANGE</b> Common-Mode Voltage Range Common-Mode Rejection Ratio <b>over Temperature</b> <b>over Temperature</b>	$V_{CM}$ CMRR $V_S = \pm 5V, (V-) - 0.3V < V_{CM} < (V+) + 0.3V$ $V_S = \pm 5V, (V-) < V_{CM} < (V+)$ $V_S = \pm 5V, (V-) - 0.3V < V_{CM} < (V+) - 2V$ $V_S = \pm 5V, (V-) < V_{CM} < (V+) - 2V$	$(V-) - 0.3$ 70 80 74	90 96	$(V+) + 0.3$   	V dB dB dB
<b>INPUT BIAS CURRENT</b> Input Bias Current Input Offset Current	$I_B$ $I_{OS}$ $V_S = \pm 5V, V_{CM} = 0V$ $V_S = \pm 5V, V_{CM} = 0V$		$\pm 1$ $\pm 0.5$	$\pm 10$ $\pm 10$	pA pA
<b>INPUT IMPEDANCE</b> Differential Common-Mode			$4 \cdot 10^9 \parallel 4$ $5 \cdot 10^{12} \parallel 4$		$\Omega \parallel pF$ $\Omega \parallel pF$
<b>NOISE</b> Input Voltage Noise, $f = 0.1Hz$ to $10Hz$ Input Voltage Noise Density, $f = 1kHz$ Current Noise Density, $f = 1kHz$	$e_n$ $e_n$ $i_n$ $V_S = \pm 5V, V_{CM} = 0V$ $V_S = \pm 5V, V_{CM} = 0V$ $V_S = \pm 5V, V_{CM} = 0V$		6 45 2.5		$\mu Vp-p$ $nV/\sqrt{Hz}$ $fA/\sqrt{Hz}$
<b>OPEN-LOOP GAIN</b> Open-Loop Voltage Gain <b>over Temperature</b> <b>over Temperature</b>	$A_{OL}$ $R_L = 100k\Omega, (V-)+0.1V < V_O < (V+)-0.1V$ $R_L = 20k\Omega, (V-)+0.075V < V_O < (V+)-0.075V$ <b><math>R_L = 20k\Omega, (V-)+0.075V &lt; V_O &lt; (V+)-0.075V</math></b> $R_L = 5k\Omega, (V-)+0.15V < V_O < (V+)-0.15V$ <b><math>R_L = 5k\Omega, (V-)+0.15V &lt; V_O &lt; (V+)-0.15V</math></b>	100 <b>96</b> 100 <b>96</b>	120 110 110		dB dB dB dB
<b>OUTPUT</b> Voltage Output Swing from Rail <b>over Temperature</b> <b>over Temperature</b> Output Current Short-Circuit Current Capacitive Load Drive	$I_{OUT}$ $I_{SC}$ $C_{LOAD}$ $R_L = 100k\Omega, A_{OL} > 80dB$ $R_L = 20k\Omega, A_{OL} > 100dB$ <b><math>R_L = 20k\Omega, A_{OL} &gt; 96dB</math></b> $R_L = 5k\Omega, A_{OL} > 100dB$ <b><math>R_L = 5k\Omega, A_{OL} &gt; 96dB</math></b> $ V_S - V_{OUT}  < 1V$		40  $\pm 10$ $\pm 40$	75 <b>75</b> 150 <b>150</b>	mV mV mV mV mA mA
<b>FREQUENCY RESPONSE</b> Gain-Bandwidth Product Slew Rate Settling Time, 0.1% 0.01% Overload Recovery Time Total Harmonic Distortion + Noise	GBW SR $t_S$ THD+N $C_L = 100pF$ $G = +5$ $V_S = \pm 5V, G = +5$ $V_S = \pm 5V, 5V$ Step, $G = +5$ $V_S = \pm 5V, 5V$ Step, $G = +5$ $V_{IN} \cdot Gain = V_S$ $V_S = \pm 5V, V_O = 3Vp-p, G = +5, f = 1kHz$		3 3 18 21 0.6 0.025		MHz V/ $\mu s$ $\mu s$ $\mu s$ $\mu s$ %
<b>POWER SUPPLY</b> Specified Voltage Range, Single Supply Specified Voltage Range, Dual Supplies Operating Voltage Range Quiescent Current (per amplifier) <b>over Temperature</b>	$V_S$ $V_S$ $I_Q$ $I_Q = 0$	4 $\pm 2$	 3.6 to 12 160	12 $\pm 6$  <b>200</b> <b>300</b>	V V V $\mu A$ $\mu A$
<b>TEMPERATURE RANGE</b> Specified Range Operating Range Storage Range Thermal Resistance SOT23-5 Surface-Mount MSOP-8 Surface-Mount TSSOP-14 Surface-Mount SO-8 Surface Mount SO-14 Surface Mount DIP-8	$\theta_{JA}$	-40 -55 -65		85 125 150  200 150 100 150 100 100	$^{\circ}C$ $^{\circ}C$ $^{\circ}C$ $^{\circ}C/W$ $^{\circ}C/W$ $^{\circ}C/W$ $^{\circ}C/W$ $^{\circ}C/W$ $^{\circ}C/W$ $^{\circ}C/W$

# TYPICAL CHARACTERISTICS

At  $T_A = +25^\circ\text{C}$ ,  $V_S = \pm 5\text{V}$ , and  $R_L = 20\text{k}\Omega$ , unless otherwise noted.

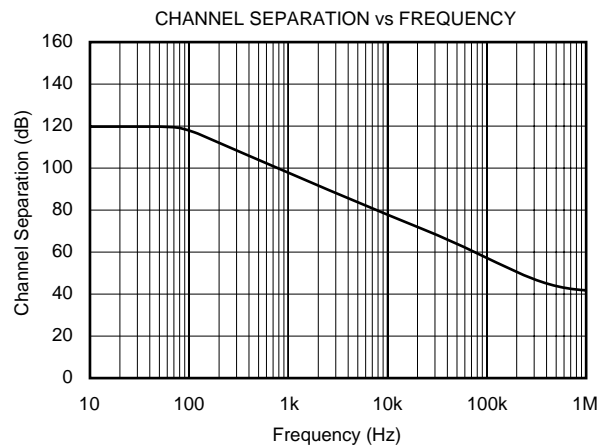
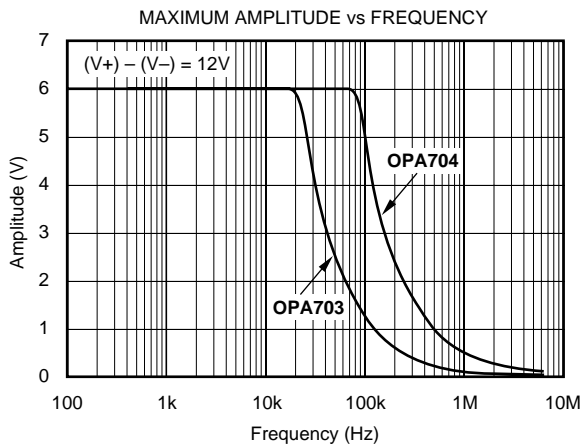
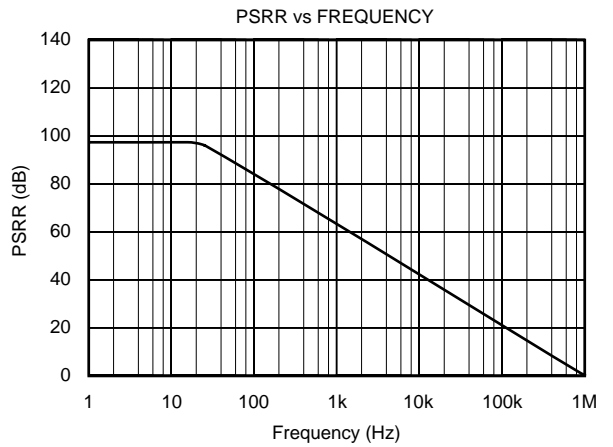
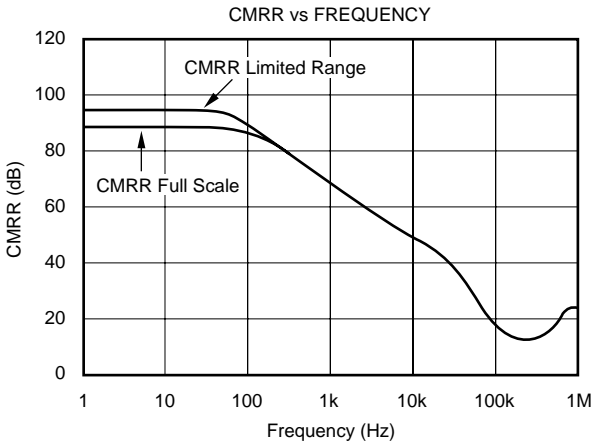
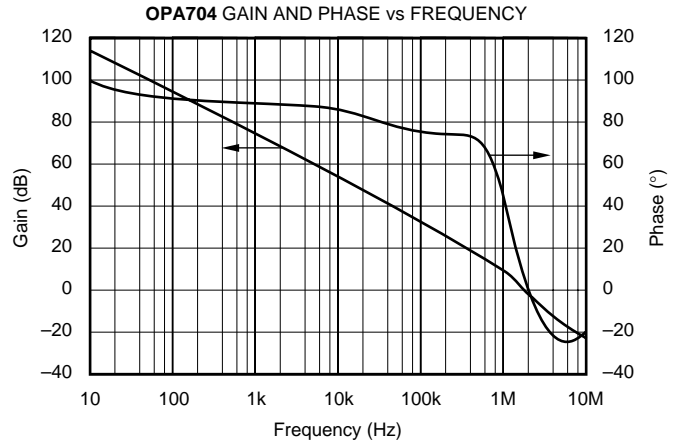
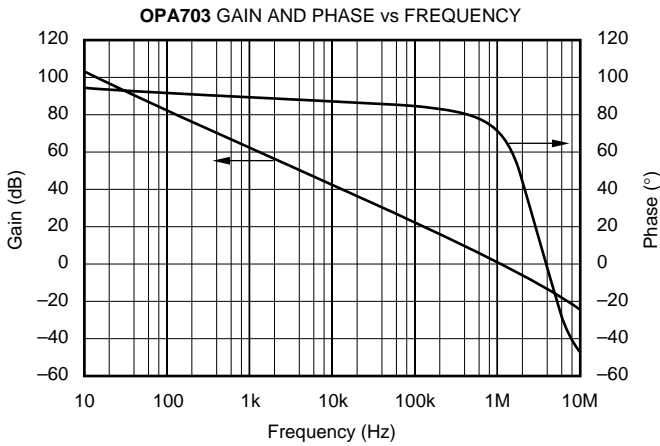

# TYPICAL CHARACTERISTICS (Cont.)

At  $T_A = +25^\circ\text{C}$ ,  $V_S = \pm 5\text{V}$ , and  $R_L = 20\text{k}\Omega$ , unless otherwise noted.

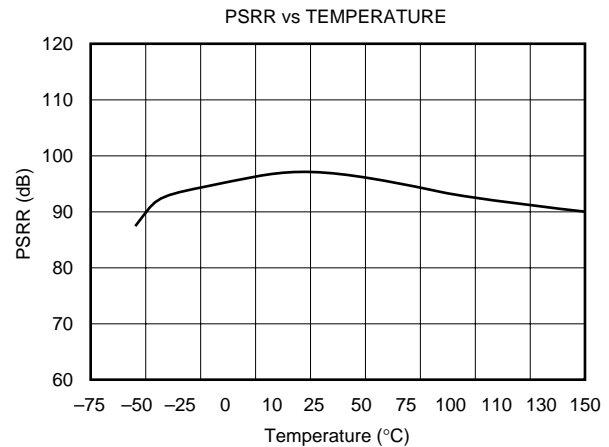
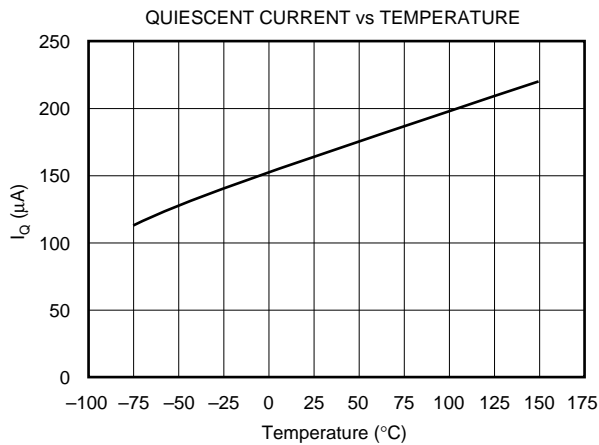
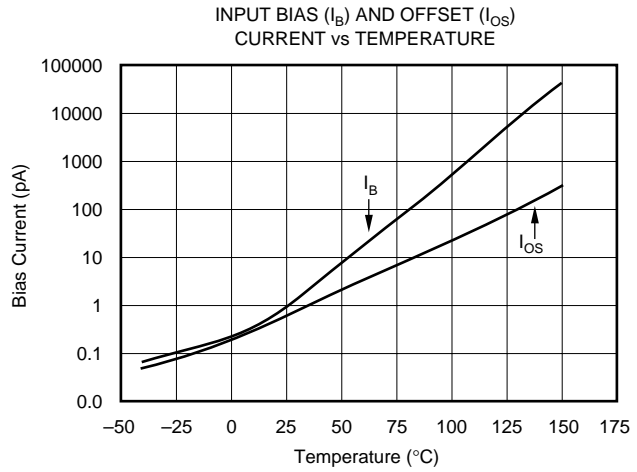
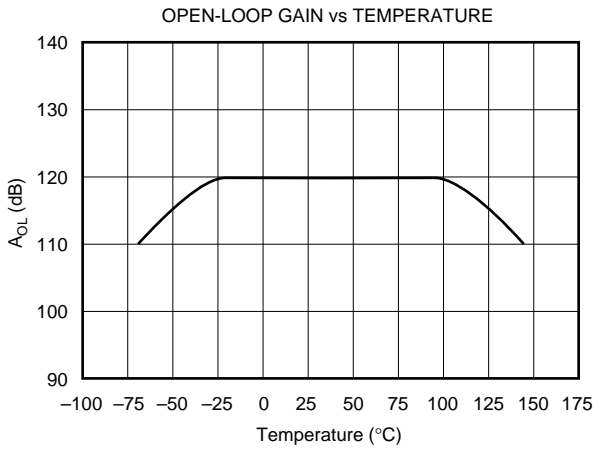
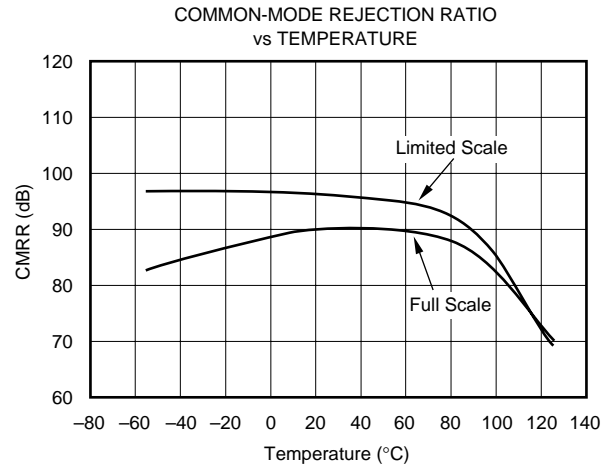
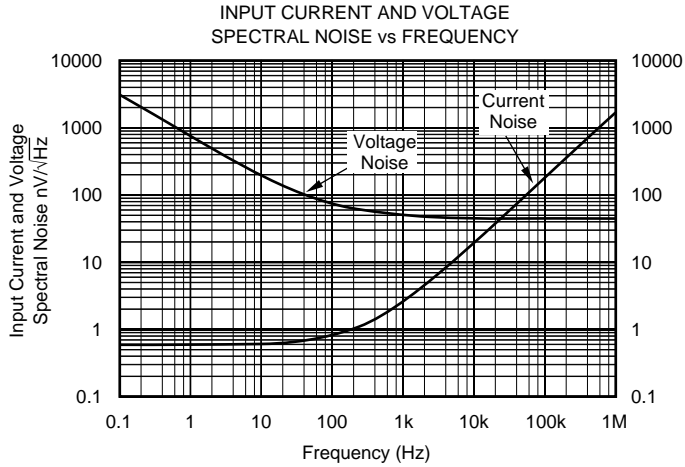

# TYPICAL CHARACTERISTICS (Cont.)

At  $T_A = +25^\circ\text{C}$ ,  $V_S = \pm 5\text{V}$ , and  $R_L = 20\text{k}\Omega$ , unless otherwise noted.

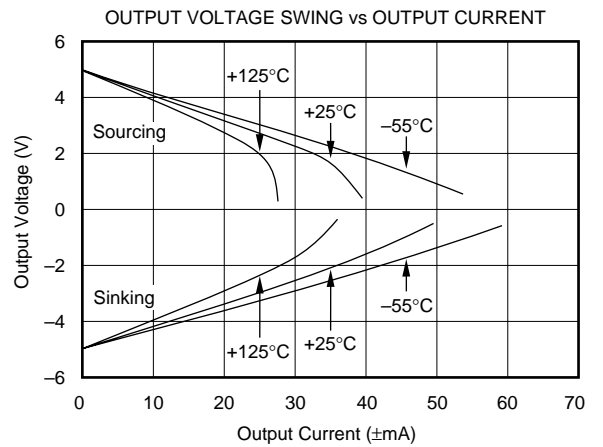
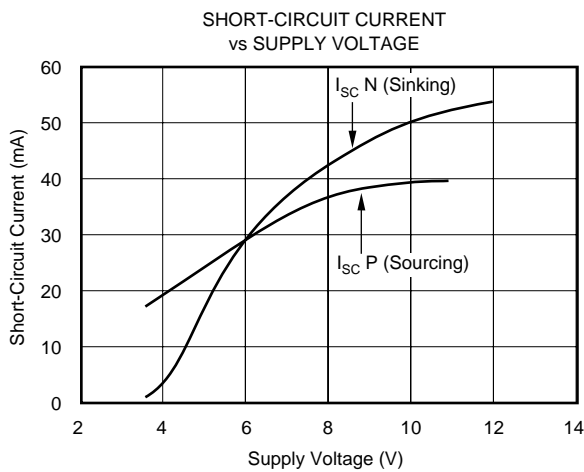
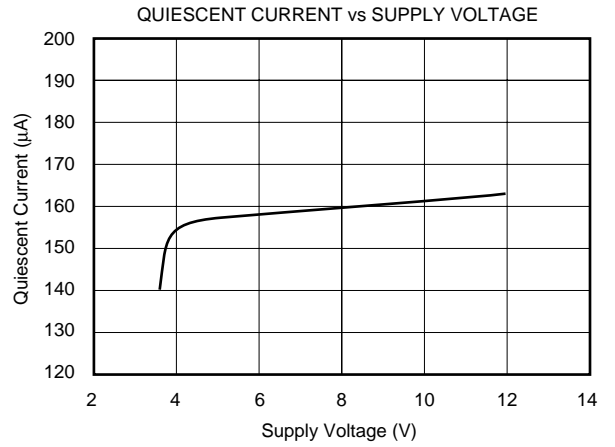
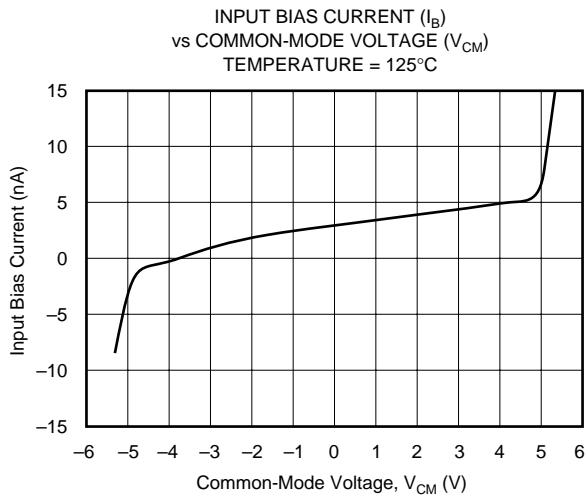
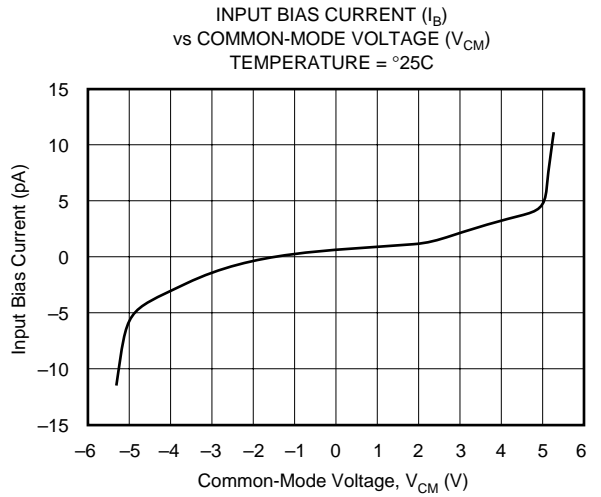
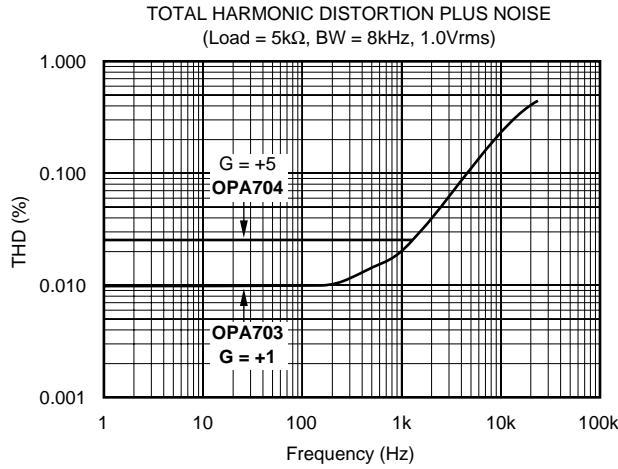

# TYPICAL CHARACTERISTICS (Cont.)

At  $T_A = +25^\circ\text{C}$ ,  $V_S = \pm 5\text{V}$ , and  $R_L = 20\text{k}\Omega$ , unless otherwise noted.

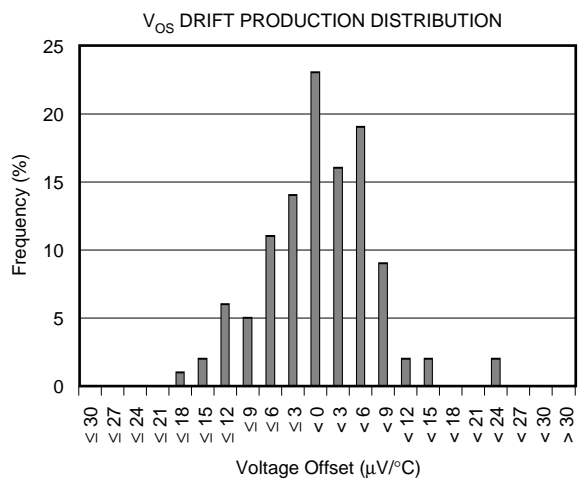
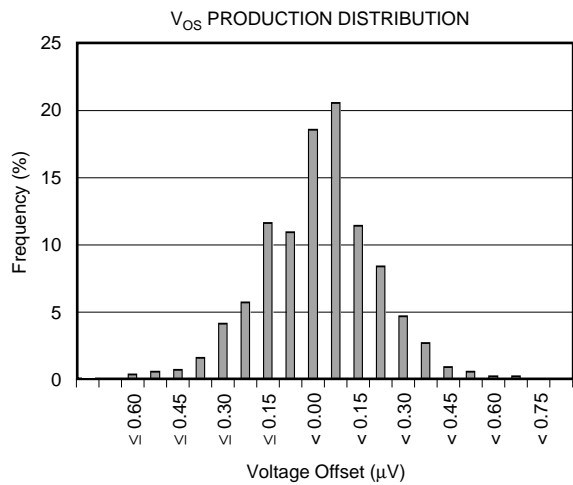
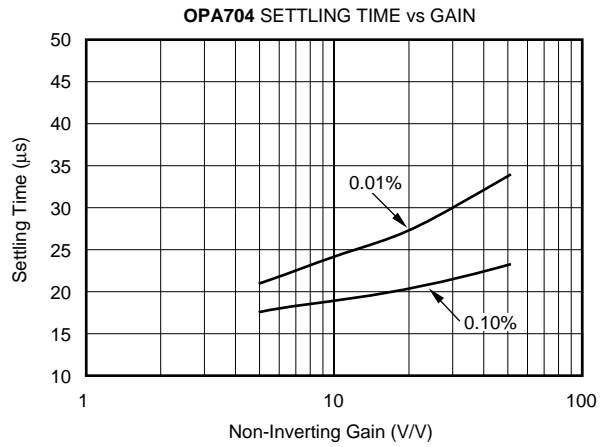
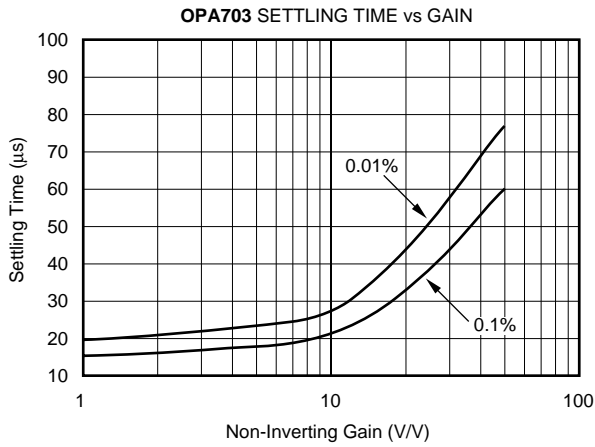
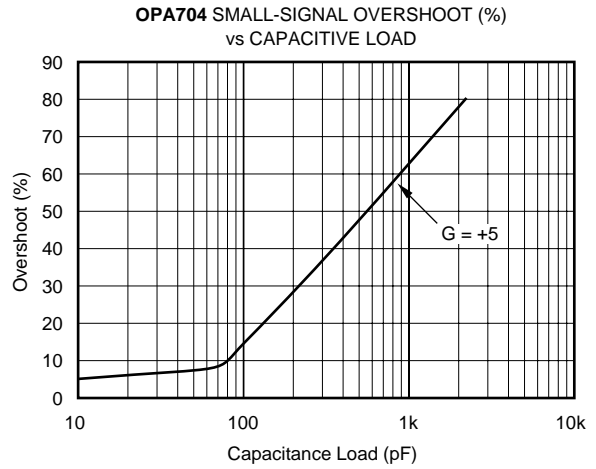
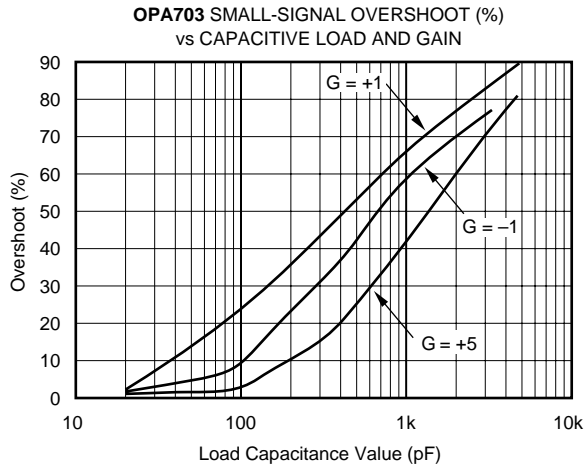



# TYPICAL CHARACTERISTICS (Cont.)

At  $T_A = +25^\circ\text{C}$ ,  $V_S = \pm 5\text{V}$ , and  $R_L = 20\text{k}\Omega$ , unless otherwise noted.

**OPA703 SMALL SIGNAL STEP RESPONSE**  
( $G = +1\text{V/V}$ ,  $R_L = 20\text{k}\Omega$ ,  $C_L = 100\text{pF}$ )

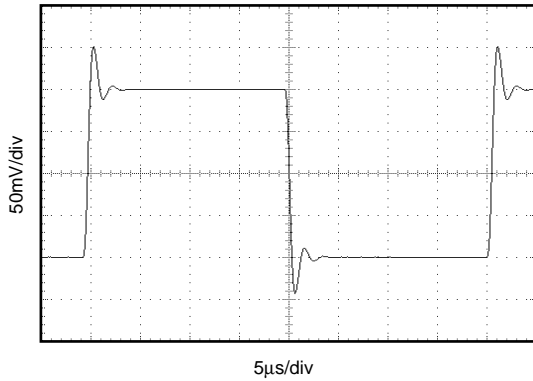

**OPA704 SMALL SIGNAL STEP RESPONSE**  
( $G = +5\text{V/V}$ ,  $C_F = 3\text{pF}$ ,  $R_F = 100\text{k}\Omega$ ,  
 $C_L = 100\text{pF}$ ,  $R_L = 20\text{k}\Omega$ )

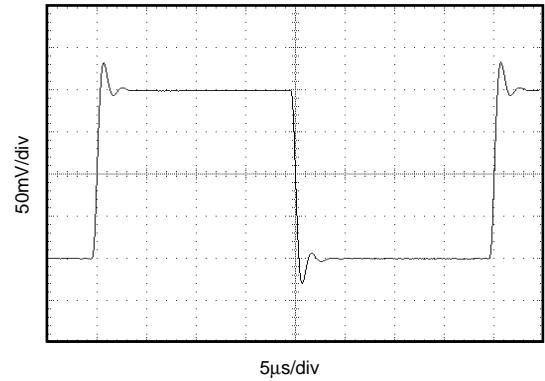

**OPA703 LARGE SIGNAL STEP RESPONSE**  
( $G = +1\text{V/V}$ ,  $R_L = 20\text{k}\Omega$ ,  $C_L = 100\text{pF}$ )

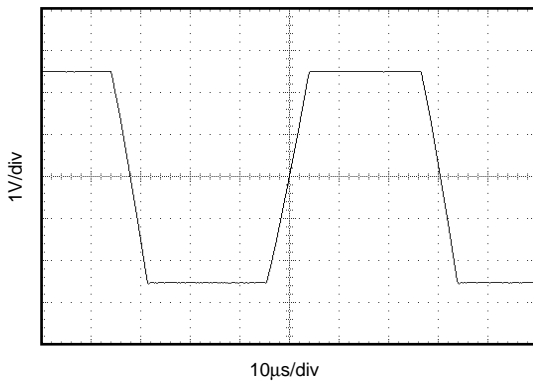

**OPA704 LARGE SIGNAL STEP RESPONSE**  
( $G = +5\text{V/V}$ ,  $R_L = 20\text{k}\Omega$ ,  $C_F = 3\text{pF}$ ,  $C_L = 100\text{pF}$ )

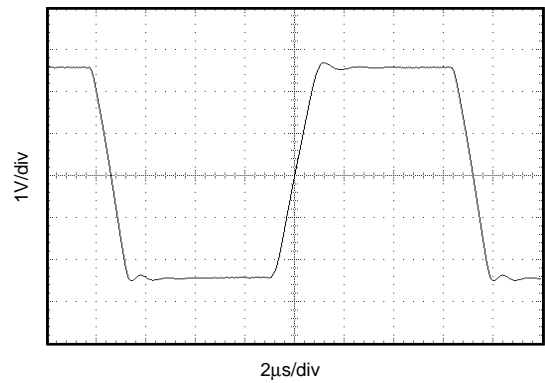

# APPLICATIONS INFORMATION

OPA703 and OPA704 series op amps can operate on 160 $\mu$ A quiescent current from a single (or split) supply in the range of 4V to 12V ( $\pm 2$ V to  $\pm 6$ V), making them highly versatile and easy to use. The OPA703 is unity-gain stable and offers 1MHz bandwidth and 0.6V/ $\mu$ s slew rate. The OPA704 is optimized for gains of 5 or greater with a 3MHz bandwidth and 3V/ $\mu$ s slew rate.

Rail-to-rail input and output swing helps maintain dynamic range, especially in low supply applications. Figure 1 shows the input and output waveforms for the OPA703 in unity-gain configuration. Operation is from a  $\pm 5$ V supply with a 100k $\Omega$  load connected to  $V_S/2$ . The input is a 10Vp-p sinusoid. Output voltage is approximately 10Vp-p.

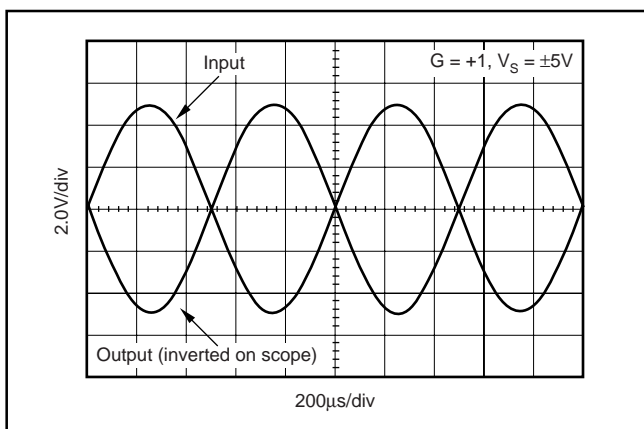

FIGURE 1. Rail-to-Rail Input and Output.

Power-supply pins should be bypassed with 1000pF ceramic capacitors in parallel with 1 $\mu$ F tantalum capacitors.

## OPERATING VOLTAGE

OPA703 and OPA704 series op amps are fully specified and guaranteed from +4V to +12V over a temperature range of  $-40^{\circ}\text{C}$  to  $+85^{\circ}\text{C}$ . Parameters that vary significantly with operating voltages or temperature are shown in the Typical Performance Curves.

## RAIL-TO-RAIL INPUT

The input common-mode voltage range of the OPA703 series extends 300mV beyond the supply rails at room temperature. This is achieved with a complementary input stage—an N-channel input differential pair in parallel with a P-channel differential pair, as shown in Figure 2. The N-channel pair is active for input voltages close to the positive rail, typically  $(V_+) - 2.0$ V to 300mV above the positive supply, while the P-channel pair is on for inputs from 300mV below the negative supply to approximately  $(V_+) - 1.5$ V. There is a small transition region, typically  $(V_+) - 2.0$ V to  $(V_+) - 1.5$ V, in which both pairs are on. This 500mV transition region can vary  $\pm 100$ mV with process variation. Thus, the transition region (both stages on) can range from  $(V_+) - 2.1$ V to  $(V_+) - 1.4$ V on the low end, up to  $(V_+) - 1.9$ V to  $(V_+) - 1.6$ V on the high end. Within the 500mV transition region PSRR, CMRR, offset voltage, and offset drift, and THD may vary compared to operation outside this region.

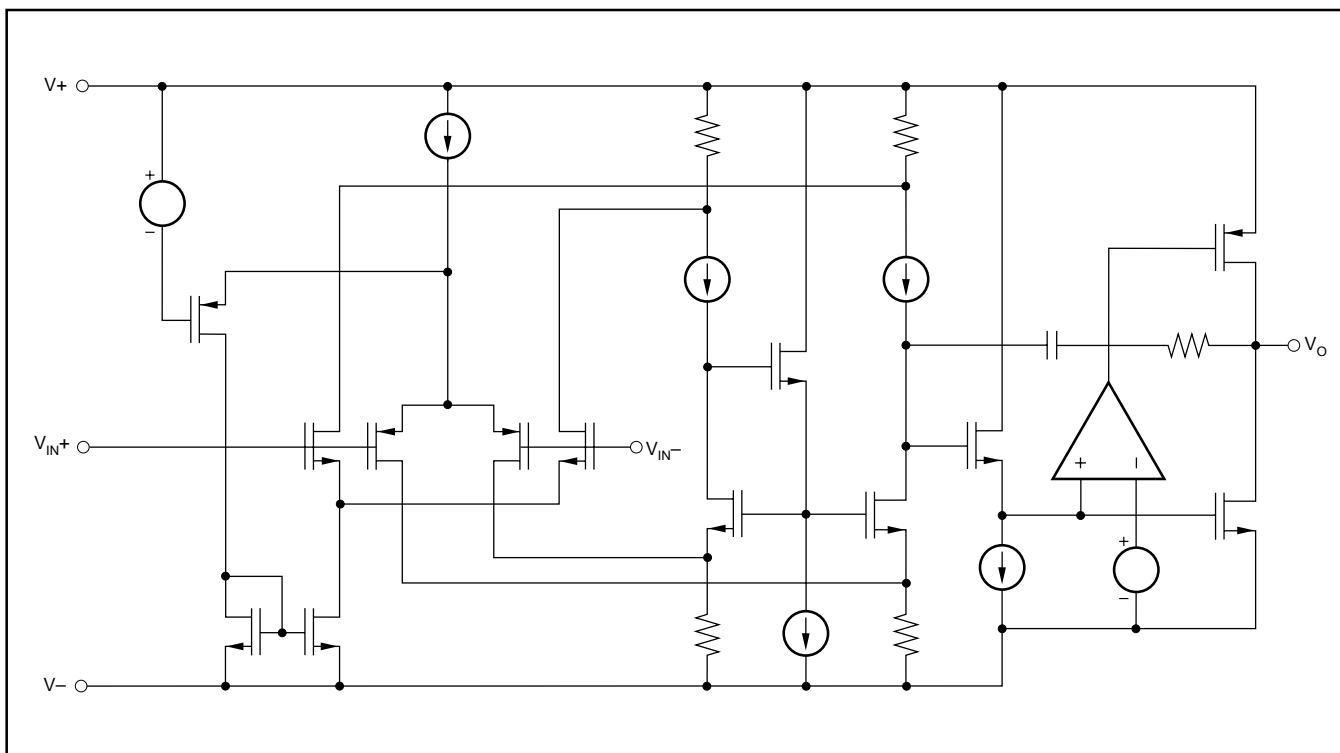

FIGURE 2. Simplified Schematic.

## INPUT VOLTAGE

Device inputs are protected by ESD diodes that will conduct if the input voltages exceed the power supplies by more than approximately 300mV. Momentary voltages greater than 300mV beyond the power supply can be tolerated if the current is limited to 10mA. This is easily accomplished with an input resistor, as shown in Figure 3. Many input signals are inherently current-limited to less than 10mA; therefore, a limiting resistor is not always required. The OPA703 features no phase inversion when the inputs extend beyond supplies if the input current is limited, as seen in Figure 4.

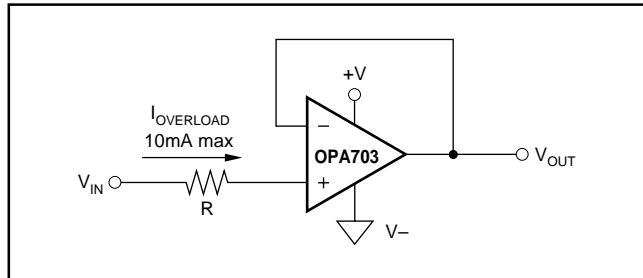

FIGURE 3. Input Current Protection for Voltages Exceeding the Supply Voltage.

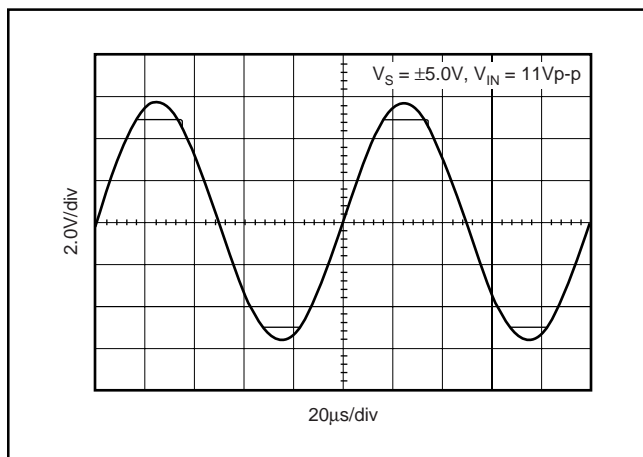

FIGURE 4. OPA703—No Phase Inversion with Inputs Greater than the Power-Supply Voltage.

## RAIL-TO-RAIL OUTPUT

A class AB output stage with common-source transistors is used to achieve rail-to-rail output. This output stage is capable of driving 1kΩ loads connected to any point between V+ and ground. For light resistive loads (> 100kΩ), the output voltage can swing to 40mV from the supply rail. With moderate resistive loads (20kΩ), the output can swing to within 75mV from the supply rails while maintaining high open-loop gain (see the typical performance curve “Output Voltage Swing vs Output Current”).

## CAPACITIVE LOAD AND STABILITY

The OPA703 and OPA704 series op amps can drive up to 1000pF pure capacitive load. Increasing the gain enhances the amplifier’s ability to drive greater capacitive loads (see the typical performance curve “Small Signal Overshoot vs Capacitive Load”).

One method of improving capacitive load drive in the unity-gain configuration is to insert a 10Ω to 20Ω resistor inside the feedback loop, as shown in Figure 5. This reduces ringing with large capacitive loads while maintaining DC accuracy.

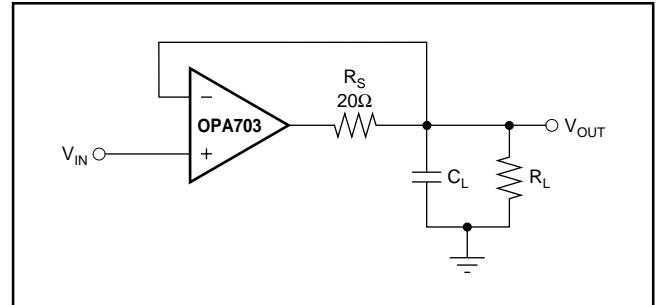

FIGURE 5. Series Resistor in Unity-Gain Buffer Configuration Improves Capacitive Load Drive.

## APPLICATION CIRCUITS

Figure 6 shows a  $G = 5$  non-inverting amplifier implemented with the OPA703 and OPA704 op amps. It demonstrates the increased speed characteristics (bandwidth, slew rate and settling time) that can be achieved with the OPA704 family when used in gains of five or greater. Some optimization of feedback capacitor value may be required to achieve best dynamic response. Circuits with closed-loop gains of less than five should use the OPA703 family for good stability and capacitive load drive. The OPA703 can be used in gains greater than five, but will not provide the increased speed benefits of the OPA704 family.

The OPA703 series op amps are optimized for driving medium-speed sampling data converters. The OPA703 op amps buffer the converter’s input capacitance and resulting charge injection while providing signal gain.

Figure 7 shows the OPA2703 in a dual-supply buffered reference configuration for the DAC7644. The DAC7644 is a 16-bit, low-power, quad-voltage output converter. Small size makes the combination ideal for automatic test equipment, data acquisition systems, and other low-power space-limited applications.

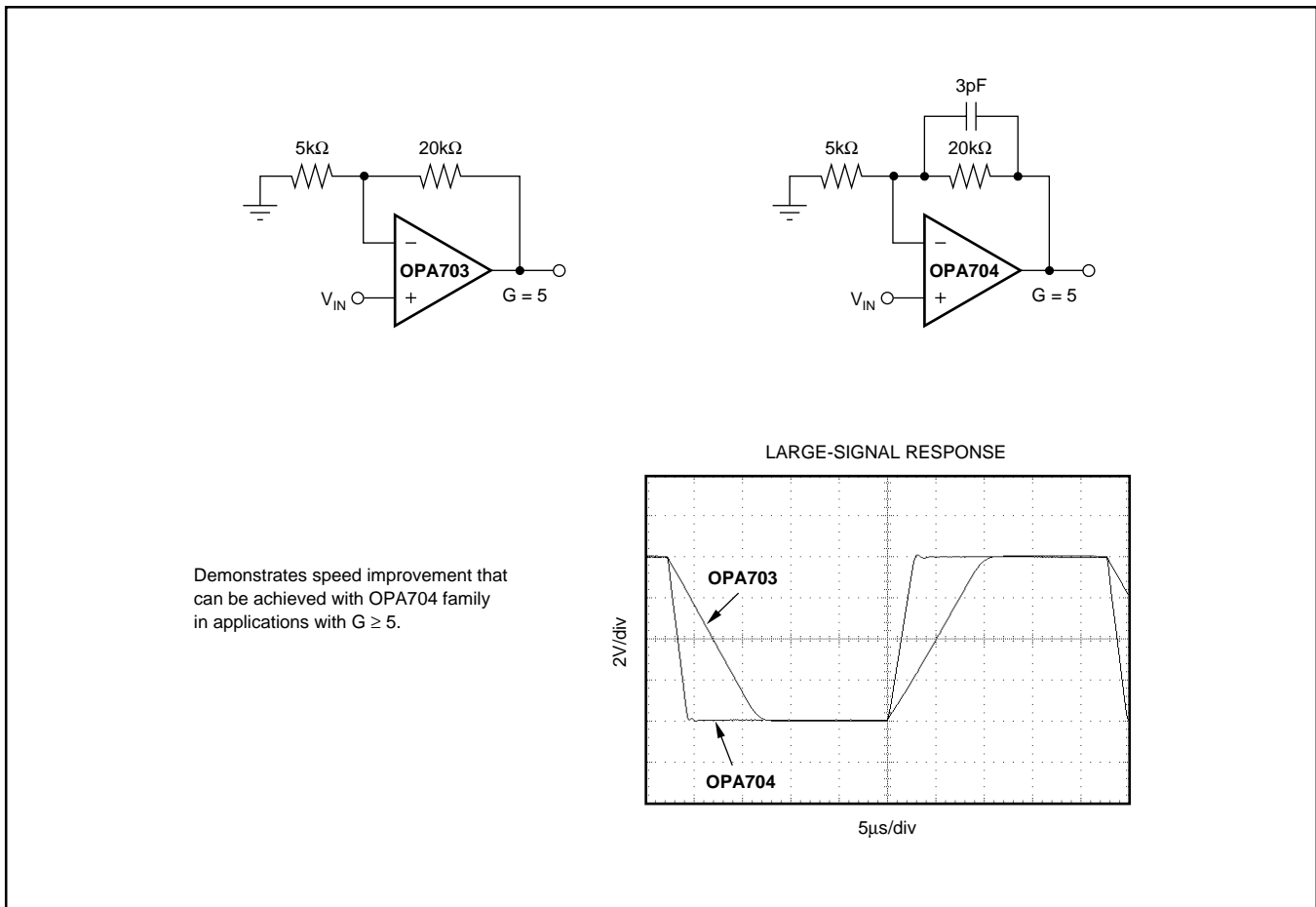

FIGURE 6. OPA704 Provides higher Speed in  $G \geq 5$ .

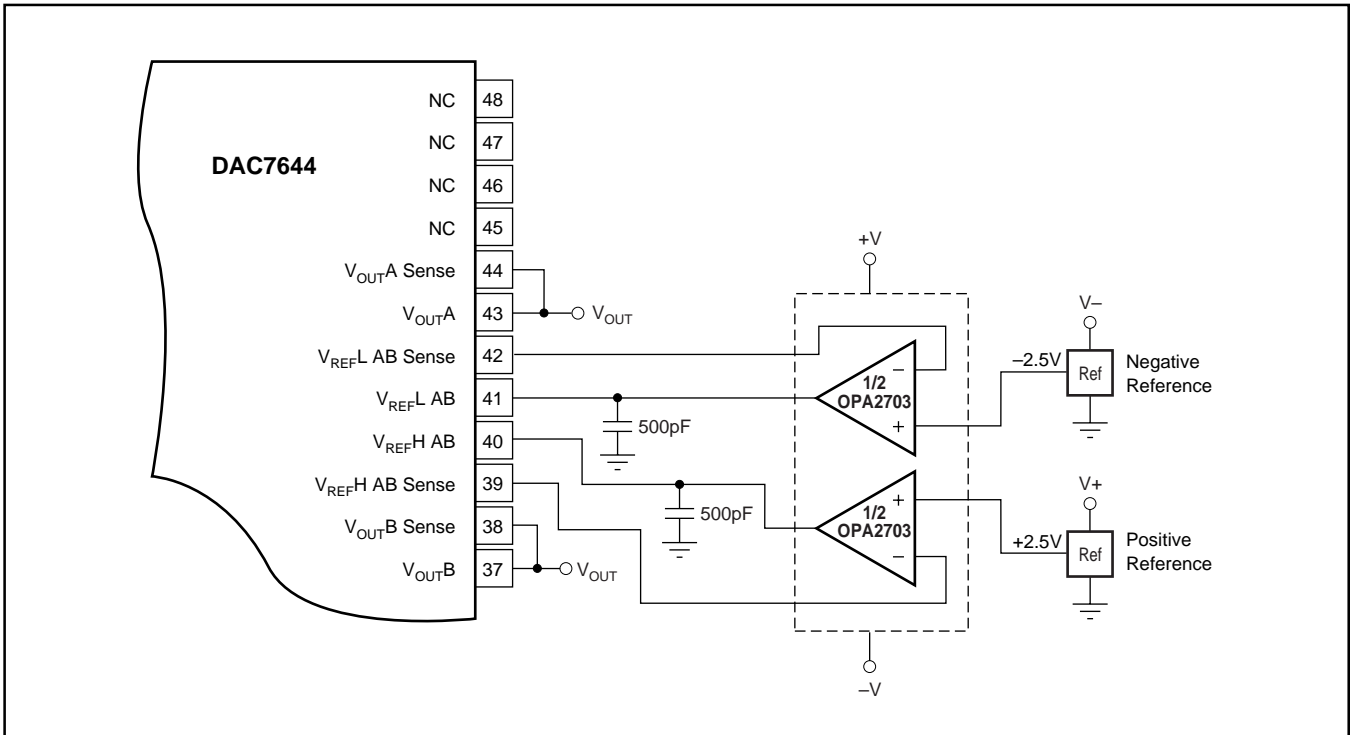

FIGURE 7. OPA703 as Dual Supply Configuration-Buffered References for the DAC7644.

**PACKAGING INFORMATION**

Orderable Device	Status (1)	Package Type	Package Drawing	Pins	Package Qty	Eco Plan (2)	Lead/Ball Finish (6)	MSL Peak Temp (3)	Op Temp (°C)	Device Marking (4/5)	Samples
OPA2703EA/250	ACTIVE	VSSOP	DGK	8	250	Green (RoHS & no Sb/Br)	CU NIPDAUAG	Level-2-260C-1 YEAR	-40 to 85	B03	<a href="#">Samples</a>
OPA2703EA/250G4	ACTIVE	VSSOP	DGK	8	250	Green (RoHS & no Sb/Br)	CU NIPDAUAG	Level-2-260C-1 YEAR	-40 to 85	B03	<a href="#">Samples</a>
OPA2703EA/2K5	ACTIVE	VSSOP	DGK	8	2500	Green (RoHS & no Sb/Br)	CU NIPDAUAG	Level-2-260C-1 YEAR	-40 to 85	B03	<a href="#">Samples</a>
OPA2703EA/2K5G4	ACTIVE	VSSOP	DGK	8	2500	Green (RoHS & no Sb/Br)	CU NIPDAUAG	Level-2-260C-1 YEAR	-40 to 85	B03	<a href="#">Samples</a>
OPA2703UA	ACTIVE	SOIC	D	8	75	Green (RoHS & no Sb/Br)	CU NIPDAU	Level-2-260C-1 YEAR	-40 to 85	OPA 2703UA	<a href="#">Samples</a>
OPA2703UA/2K5	ACTIVE	SOIC	D	8	2500	Green (RoHS & no Sb/Br)	CU NIPDAU	Level-2-260C-1 YEAR	-40 to 85	OPA 2703UA	<a href="#">Samples</a>
OPA2703UA/2K5G4	ACTIVE	SOIC	D	8	2500	Green (RoHS & no Sb/Br)	CU NIPDAU	Level-2-260C-1 YEAR	-40 to 85	OPA 2703UA	<a href="#">Samples</a>
OPA2704EA/250	ACTIVE	VSSOP	DGK	8	250	Green (RoHS & no Sb/Br)	CU NIPDAUAG	Level-2-260C-1 YEAR	-40 to 85	B04	<a href="#">Samples</a>
OPA2704EA/250G4	ACTIVE	VSSOP	DGK	8	250	Green (RoHS & no Sb/Br)	CU NIPDAUAG	Level-2-260C-1 YEAR	-40 to 85	B04	<a href="#">Samples</a>
OPA2704UA	ACTIVE	SOIC	D	8	75	Green (RoHS & no Sb/Br)	CU NIPDAU	Level-2-260C-1 YEAR	-40 to 85	OPA 2704UA	<a href="#">Samples</a>
OPA2704UA/2K5	ACTIVE	SOIC	D	8	2500	Green (RoHS & no Sb/Br)	CU NIPDAU	Level-2-260C-1 YEAR	-40 to 85	OPA 2704UA	<a href="#">Samples</a>
OPA2704UA/2K5G4	ACTIVE	SOIC	D	8	2500	Green (RoHS & no Sb/Br)	CU NIPDAU	Level-2-260C-1 YEAR	-40 to 85	OPA 2704UA	<a href="#">Samples</a>
OPA4703EA/250	ACTIVE	TSSOP	PW	14	250	Green (RoHS & no Sb/Br)	CU NIPDAU	Level-2-260C-1 YEAR	-40 to 85	OPA 4703EA	<a href="#">Samples</a>
OPA4703EA/250G4	ACTIVE	TSSOP	PW	14	250	Green (RoHS & no Sb/Br)	CU NIPDAU	Level-2-260C-1 YEAR	-40 to 85	OPA 4703EA	<a href="#">Samples</a>
OPA4703EA/2K5	ACTIVE	TSSOP	PW	14	2500	Green (RoHS & no Sb/Br)	CU NIPDAU	Level-2-260C-1 YEAR	-40 to 85	OPA 4703EA	<a href="#">Samples</a>
OPA4703EA/2K5G4	ACTIVE	TSSOP	PW	14	2500	Green (RoHS & no Sb/Br)	CU NIPDAU	Level-2-260C-1 YEAR	-40 to 85	OPA 4703EA	<a href="#">Samples</a>
OPA4703UA	ACTIVE	SOIC	D	14	50	Green (RoHS & no Sb/Br)	CU NIPDAU	Level-2-260C-1 YEAR	-40 to 85	OPA4703UA	<a href="#">Samples</a>

Orderable Device	Status (1)	Package Type	Package Drawing	Pins	Package Qty	Eco Plan (2)	Lead/Ball Finish (6)	MSL Peak Temp (3)	Op Temp (°C)	Device Marking (4/5)	Samples
OPA4703UAG4	ACTIVE	SOIC	D	14	50	Green (RoHS & no Sb/Br)	CU NIPDAU	Level-2-260C-1 YEAR	-40 to 85	OPA4703UA	<a href="#">Samples</a>
OPA4704EA/250	ACTIVE	TSSOP	PW	14	250	Green (RoHS & no Sb/Br)	CU NIPDAU	Level-2-260C-1 YEAR	-40 to 85	OPA 4704EA	<a href="#">Samples</a>
OPA4704EA/250G4	ACTIVE	TSSOP	PW	14	250	Green (RoHS & no Sb/Br)	CU NIPDAU	Level-2-260C-1 YEAR	-40 to 85	OPA 4704EA	<a href="#">Samples</a>
OPA4704EA/2K5	ACTIVE	TSSOP	PW	14	2500	Green (RoHS & no Sb/Br)	CU NIPDAU	Level-2-260C-1 YEAR	-40 to 85	OPA 4704EA	<a href="#">Samples</a>
OPA4704UA	ACTIVE	SOIC	D	14	50	Green (RoHS & no Sb/Br)	CU NIPDAU	Level-2-260C-1 YEAR	-40 to 85	OPA4704UA	<a href="#">Samples</a>
OPA703NA/250	ACTIVE	SOT-23	DBV	5	250	Green (RoHS & no Sb/Br)	CU NIPDAU	Level-2-260C-1 YEAR	-40 to 85	A03	<a href="#">Samples</a>
OPA703NA/250G4	ACTIVE	SOT-23	DBV	5	250	Green (RoHS & no Sb/Br)	CU NIPDAU	Level-2-260C-1 YEAR	-40 to 85	A03	<a href="#">Samples</a>
OPA703NA/3K	ACTIVE	SOT-23	DBV	5	3000	Green (RoHS & no Sb/Br)	CU NIPDAU	Level-2-260C-1 YEAR	-40 to 85	A03	<a href="#">Samples</a>
OPA703NA/3KG4	ACTIVE	SOT-23	DBV	5	3000	Green (RoHS & no Sb/Br)	CU NIPDAU	Level-2-260C-1 YEAR	-40 to 85	A03	<a href="#">Samples</a>
OPA703PA	ACTIVE	PDIP	P	8	50	Green (RoHS & no Sb/Br)	CU NIPDAU	N / A for Pkg Type	-40 to 85	OPA703PA	<a href="#">Samples</a>
OPA703UA	ACTIVE	SOIC	D	8	75	Green (RoHS & no Sb/Br)	CU NIPDAU	Level-2-260C-1 YEAR	-40 to 85	OPA 703UA	<a href="#">Samples</a>
OPA703UA/2K5	ACTIVE	SOIC	D	8	2500	Green (RoHS & no Sb/Br)	CU NIPDAU	Level-2-260C-1 YEAR	-40 to 85	OPA 703UA	<a href="#">Samples</a>
OPA704NA/250	ACTIVE	SOT-23	DBV	5	250	Green (RoHS & no Sb/Br)	CU NIPDAU	Level-2-260C-1 YEAR	-40 to 85	A04	<a href="#">Samples</a>
OPA704NA/250G4	ACTIVE	SOT-23	DBV	5	250	Green (RoHS & no Sb/Br)	CU NIPDAU	Level-2-260C-1 YEAR	-40 to 85	A04	<a href="#">Samples</a>
OPA704NA/3K	ACTIVE	SOT-23	DBV	5	3000	Green (RoHS & no Sb/Br)	CU NIPDAU	Level-2-260C-1 YEAR	-40 to 85	A04	<a href="#">Samples</a>
OPA704NA/3KG4	ACTIVE	SOT-23	DBV	5	3000	Green (RoHS & no Sb/Br)	CU NIPDAU	Level-2-260C-1 YEAR	-40 to 85	A04	<a href="#">Samples</a>
OPA704UA	ACTIVE	SOIC	D	8	75	Green (RoHS & no Sb/Br)	CU NIPDAU	Level-2-260C-1 YEAR	-40 to 85	OPA 704UA	<a href="#">Samples</a>
OPA704UA/2K5	ACTIVE	SOIC	D	8	2500	Green (RoHS & no Sb/Br)	CU NIPDAU	Level-2-260C-1 YEAR	-40 to 85	OPA 704UA	<a href="#">Samples</a>

(1) The marketing status values are defined as follows:

**ACTIVE:** Product device recommended for new designs.

**LIFEBUY:** TI has announced that the device will be discontinued, and a lifetime-buy period is in effect.

**NRND:** Not recommended for new designs. Device is in production to support existing customers, but TI does not recommend using this part in a new design.

**PREVIEW:** Device has been announced but is not in production. Samples may or may not be available.

**OBSOLETE:** TI has discontinued the production of the device.

(2) **RoHS:** TI defines "RoHS" to mean semiconductor products that are compliant with the current EU RoHS requirements for all 10 RoHS substances, including the requirement that RoHS substance do not exceed 0.1% by weight in homogeneous materials. Where designed to be soldered at high temperatures, "RoHS" products are suitable for use in specified lead-free processes. TI may reference these types of products as "Pb-Free".

**RoHS Exempt:** TI defines "RoHS Exempt" to mean products that contain lead but are compliant with EU RoHS pursuant to a specific EU RoHS exemption.

**Green:** TI defines "Green" to mean the content of Chlorine (Cl) and Bromine (Br) based flame retardants meet JS709B low halogen requirements of  $\leq 1000$ ppm threshold. Antimony trioxide based flame retardants must also meet the  $\leq 1000$ ppm threshold requirement.

(3) MSL, Peak Temp. - The Moisture Sensitivity Level rating according to the JEDEC industry standard classifications, and peak solder temperature.

(4) There may be additional marking, which relates to the logo, the lot trace code information, or the environmental category on the device.

(5) Multiple Device Markings will be inside parentheses. Only one Device Marking contained in parentheses and separated by a "~" will appear on a device. If a line is indented then it is a continuation of the previous line and the two combined represent the entire Device Marking for that device.

(6) Lead/Ball Finish - Orderable Devices may have multiple material finish options. Finish options are separated by a vertical ruled line. Lead/Ball Finish values may wrap to two lines if the finish value exceeds the maximum column width.

**Important Information and Disclaimer:** The information provided on this page represents TI's knowledge and belief as of the date that it is provided. TI bases its knowledge and belief on information provided by third parties, and makes no representation or warranty as to the accuracy of such information. Efforts are underway to better integrate information from third parties. TI has taken and continues to take reasonable steps to provide representative and accurate information but may not have conducted destructive testing or chemical analysis on incoming materials and chemicals. TI and TI suppliers consider certain information to be proprietary, and thus CAS numbers and other limited information may not be available for release.

In no event shall TI's liability arising out of such information exceed the total purchase price of the TI part(s) at issue in this document sold by TI to Customer on an annual basis.

**TAPE AND REEL INFORMATION**

**QUADRANT ASSIGNMENTS FOR PIN 1 ORIENTATION IN TAPE**

\*All dimensions are nominal

Device	Package Type	Package Drawing	Pins	SPQ	Reel Diameter (mm)	Reel Width W1 (mm)	A0 (mm)	B0 (mm)	K0 (mm)	P1 (mm)	W (mm)	Pin1 Quadrant
OPA2703EA/250	VSSOP	DGK	8	250	180.0	12.4	5.3	3.4	1.4	8.0	12.0	Q1
OPA2703EA/2K5	VSSOP	DGK	8	2500	330.0	12.4	5.3	3.4	1.4	8.0	12.0	Q1
OPA2703UA/2K5	SOIC	D	8	2500	330.0	12.4	6.4	5.2	2.1	8.0	12.0	Q1
OPA2704EA/250	VSSOP	DGK	8	250	180.0	12.4	5.3	3.4	1.4	8.0	12.0	Q1
OPA2704UA/2K5	SOIC	D	8	2500	330.0	12.4	6.4	5.2	2.1	8.0	12.0	Q1
OPA4703EA/250	TSSOP	PW	14	250	180.0	12.4	6.9	5.6	1.6	8.0	12.0	Q1
OPA4703EA/2K5	TSSOP	PW	14	2500	330.0	12.4	6.9	5.6	1.6	8.0	12.0	Q1
OPA4704EA/250	TSSOP	PW	14	250	180.0	12.4	6.9	5.6	1.6	8.0	12.0	Q1
OPA4704EA/2K5	TSSOP	PW	14	2500	330.0	12.4	6.9	5.6	1.6	8.0	12.0	Q1
OPA703NA/250	SOT-23	DBV	5	250	178.0	8.4	3.3	3.2	1.4	4.0	8.0	Q3
OPA703NA/3K	SOT-23	DBV	5	3000	178.0	8.4	3.3	3.2	1.4	4.0	8.0	Q3
OPA703UA/2K5	SOIC	D	8	2500	330.0	12.4	6.4	5.2	2.1	8.0	12.0	Q1
OPA704NA/250	SOT-23	DBV	5	250	178.0	8.4	3.3	3.2	1.4	4.0	8.0	Q3
OPA704NA/3K	SOT-23	DBV	5	3000	178.0	8.4	3.23	3.17	1.37	4.0	8.0	Q3
OPA704UA/2K5	SOIC	D	8	2500	330.0	12.4	6.4	5.2	2.1	8.0	12.0	Q1



**TAPE AND REEL BOX DIMENSIONS**

\*All dimensions are nominal

Device	Package Type	Package Drawing	Pins	SPQ	Length (mm)	Width (mm)	Height (mm)
OPA2703EA/250	VSSOP	DGK	8	250	210.0	185.0	35.0
OPA2703EA/2K5	VSSOP	DGK	8	2500	367.0	367.0	35.0
OPA2703UA/2K5	SOIC	D	8	2500	367.0	367.0	35.0
OPA2704EA/250	VSSOP	DGK	8	250	210.0	185.0	35.0
OPA2704UA/2K5	SOIC	D	8	2500	367.0	367.0	35.0
OPA4703EA/250	TSSOP	PW	14	250	210.0	185.0	35.0
OPA4703EA/2K5	TSSOP	PW	14	2500	367.0	367.0	35.0
OPA4704EA/250	TSSOP	PW	14	250	210.0	185.0	35.0
OPA4704EA/2K5	TSSOP	PW	14	2500	367.0	367.0	35.0
OPA703NA/250	SOT-23	DBV	5	250	565.0	140.0	75.0
OPA703NA/3K	SOT-23	DBV	5	3000	565.0	140.0	75.0
OPA703UA/2K5	SOIC	D	8	2500	367.0	367.0	35.0
OPA704NA/250	SOT-23	DBV	5	250	565.0	140.0	75.0
OPA704NA/3K	SOT-23	DBV	5	3000	565.0	140.0	75.0
OPA704UA/2K5	SOIC	D	8	2500	367.0	367.0	35.0

D (R-PDSO-G14)

PLASTIC SMALL OUTLINE



- NOTES:
- A. All linear dimensions are in inches (millimeters).
  - B. This drawing is subject to change without notice.
  - Body length does not include mold flash, protrusions, or gate burrs. Mold flash, protrusions, or gate burrs shall not exceed 0.006 (0,15) each side.
  - Body width does not include interlead flash. Interlead flash shall not exceed 0.017 (0,43) each side.
  - E. Reference JEDEC MS-012 variation AB.

D (R-PDSO-G14)

PLASTIC SMALL OUTLINE



4211283-3/E 08/12

- NOTES:
- All linear dimensions are in millimeters.
  - This drawing is subject to change without notice.
  - Publication IPC-7351 is recommended for alternate designs.
  - Laser cutting apertures with trapezoidal walls and also rounding corners will offer better paste release. Customers should contact their board assembly site for stencil design recommendations. Refer to IPC-7525 for other stencil recommendations.
  - Customers should contact their board fabrication site for solder mask tolerances between and around signal pads.

PW (R-PDSO-G14)

PLASTIC SMALL OUTLINE



4040064-3/G 02/11

- NOTES:
- A. All linear dimensions are in millimeters. Dimensioning and tolerancing per ASME Y14.5M-1994.
  - B. This drawing is subject to change without notice.
  -  C. Body length does not include mold flash, protrusions, or gate burrs. Mold flash, protrusions, or gate burrs shall not exceed 0,15 each side.
  -  D. Body width does not include interlead flash. Interlead flash shall not exceed 0,25 each side.
  - E. Falls within JEDEC MO-153

PW (R-PDSO-G14)

PLASTIC SMALL OUTLINE



4211284-2/G 08/15

- NOTES:
- All linear dimensions are in millimeters.
  - This drawing is subject to change without notice.
  - Publication IPC-7351 is recommended for alternate designs.
  - Laser cutting apertures with trapezoidal walls and also rounding corners will offer better paste release. Customers should contact their board assembly site for stencil design recommendations. Refer to IPC-7525 for other stencil recommendations.
  - Customers should contact their board fabrication site for solder mask tolerances between and around signal pads.



D0008A

# PACKAGE OUTLINE

SOIC - 1.75 mm max height

SMALL OUTLINE INTEGRATED CIRCUIT



4214825/C 02/2019

NOTES:

1. Linear dimensions are in inches [millimeters]. Dimensions in parenthesis are for reference only. Controlling dimensions are in inches. Dimensioning and tolerancing per ASME Y14.5M.
2. This drawing is subject to change without notice.
3. This dimension does not include mold flash, protrusions, or gate burrs. Mold flash, protrusions, or gate burrs shall not exceed  $.006$  [0.15] per side.
4. This dimension does not include interlead flash.
5. Reference JEDEC registration MS-012, variation AA.

# EXAMPLE BOARD LAYOUT

D0008A

SOIC - 1.75 mm max height

SMALL OUTLINE INTEGRATED CIRCUIT



LAND PATTERN EXAMPLE  
EXPOSED METAL SHOWN  
SCALE:8X



SOLDER MASK DETAILS

4214825/C 02/2019

NOTES: (continued)

- 6. Publication IPC-7351 may have alternate designs.
- 7. Solder mask tolerances between and around signal pads can vary based on board fabrication site.

# EXAMPLE STENCIL DESIGN

D0008A

SOIC - 1.75 mm max height

SMALL OUTLINE INTEGRATED CIRCUIT



SOLDER PASTE EXAMPLE  
BASED ON .005 INCH [0.125 MM] THICK STENCIL  
SCALE:8X

4214825/C 02/2019

NOTES: (continued)

8. Laser cutting apertures with trapezoidal walls and rounded corners may offer better paste release. IPC-7525 may have alternate design recommendations.
9. Board assembly site may have different recommendations for stencil design.



P (R-PDIP-T8)

PLASTIC DUAL-IN-LINE PACKAGE



- NOTES:
- A. All linear dimensions are in inches (millimeters).
  - B. This drawing is subject to change without notice.
  - C. Falls within JEDEC MS-001 variation BA.

DBV0005A



# PACKAGE OUTLINE

SOT-23 - 1.45 mm max height

SMALL OUTLINE TRANSISTOR

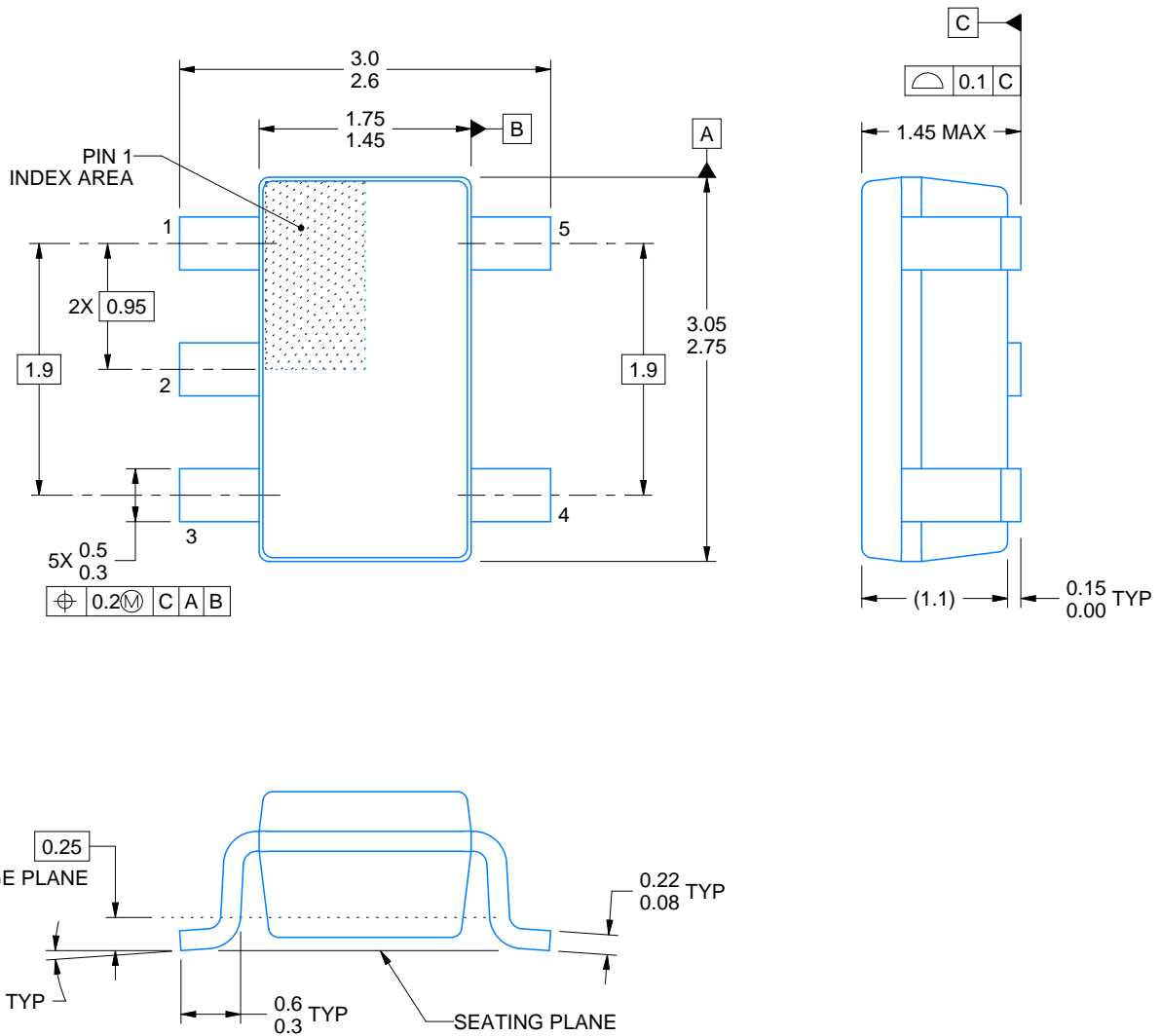

4214839/D 11/2018

NOTES:

1. All linear dimensions are in millimeters. Any dimensions in parenthesis are for reference only. Dimensioning and tolerancing per ASME Y14.5M.
2. This drawing is subject to change without notice.
3. Reference JEDEC MO-178.
4. Body dimensions do not include mold flash, protrusions, or gate burrs. Mold flash, protrusions, or gate burrs shall not exceed 0.15 mm per side.

# EXAMPLE BOARD LAYOUT

DBV0005A

SOT-23 - 1.45 mm max height

SMALL OUTLINE TRANSISTOR

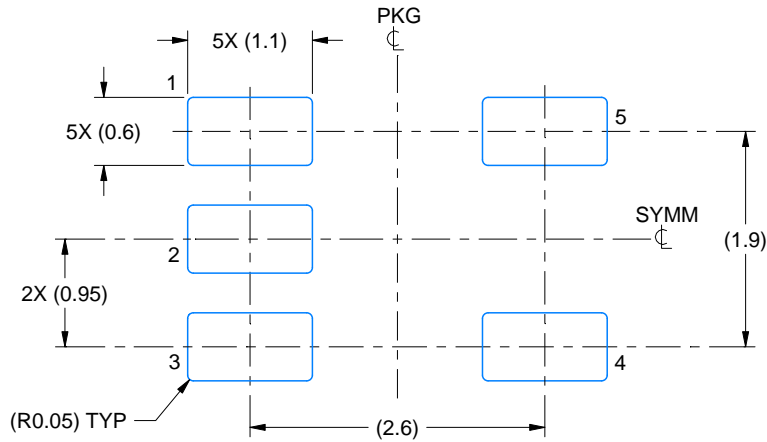

LAND PATTERN EXAMPLE  
EXPOSED METAL SHOWN  
SCALE:15X

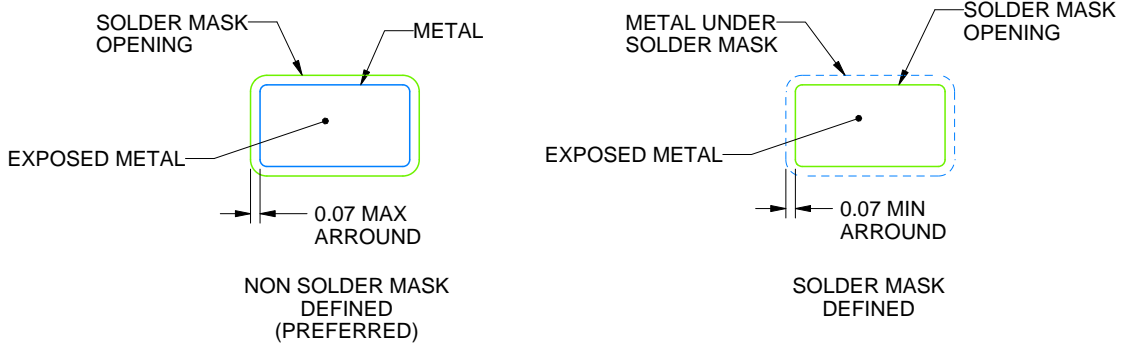

SOLDER MASK DETAILS

4214839/D 11/2018

NOTES: (continued)

- 5. Publication IPC-7351 may have alternate designs.
- 6. Solder mask tolerances between and around signal pads can vary based on board fabrication site.

# EXAMPLE STENCIL DESIGN

DBV0005A

SOT-23 - 1.45 mm max height

SMALL OUTLINE TRANSISTOR

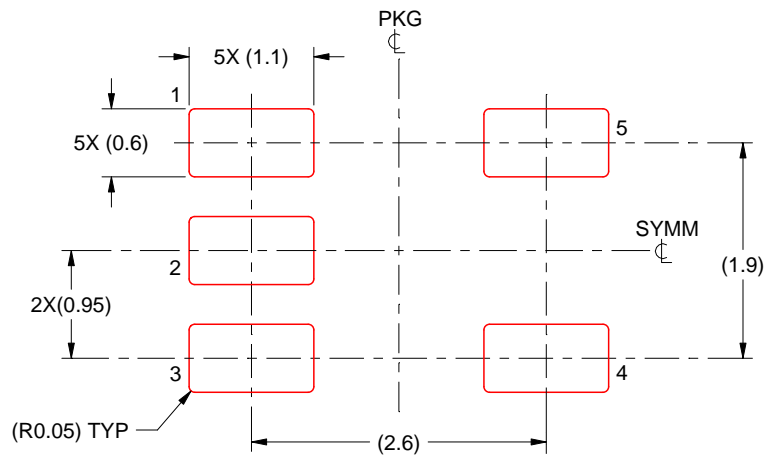

SOLDER PASTE EXAMPLE  
BASED ON 0.125 mm THICK STENCIL  
SCALE:15X

4214839/D 11/2018

NOTES: (continued)

7. Laser cutting apertures with trapezoidal walls and rounded corners may offer better paste release. IPC-7525 may have alternate design recommendations.
8. Board assembly site may have different recommendations for stencil design.

DGK (S-PDSO-G8)

PLASTIC SMALL-OUTLINE PACKAGE



- NOTES:
- A. All linear dimensions are in millimeters.
  - B. This drawing is subject to change without notice.
  - C. Body length does not include mold flash, protrusions, or gate burrs. Mold flash, protrusions, or gate burrs shall not exceed 0.15 per end.
  - D. Body width does not include interlead flash. Interlead flash shall not exceed 0.50 per side.
  - E. Falls within JEDEC MO-187 variation AA, except interlead flash.



- NOTES:
- A. All linear dimensions are in millimeters.
  - B. This drawing is subject to change without notice.
  - C. Publication IPC-7351 is recommended for alternate designs.
  - D. Laser cutting apertures with trapezoidal walls and also rounding corners will offer better paste release. Customers should contact their board assembly site for stencil design recommendations. Refer to IPC-7525 for other stencil recommendations.
  - E. Customers should contact their board fabrication site for solder mask tolerances between and around signal pads.

## IMPORTANT NOTICE AND DISCLAIMER

TI PROVIDES TECHNICAL AND RELIABILITY DATA (INCLUDING DATASHEETS), DESIGN RESOURCES (INCLUDING REFERENCE DESIGNS), APPLICATION OR OTHER DESIGN ADVICE, WEB TOOLS, SAFETY INFORMATION, AND OTHER RESOURCES "AS IS" AND WITH ALL FAULTS, AND DISCLAIMS ALL WARRANTIES, EXPRESS AND IMPLIED, INCLUDING WITHOUT LIMITATION ANY IMPLIED WARRANTIES OF MERCHANTABILITY, FITNESS FOR A PARTICULAR PURPOSE OR NON-INFRINGEMENT OF THIRD PARTY INTELLECTUAL PROPERTY RIGHTS.

These resources are intended for skilled developers designing with TI products. You are solely responsible for (1) selecting the appropriate TI products for your application, (2) designing, validating and testing your application, and (3) ensuring your application meets applicable standards, and any other safety, security, or other requirements. These resources are subject to change without notice. TI grants you permission to use these resources only for development of an application that uses the TI products described in the resource. Other reproduction and display of these resources is prohibited. No license is granted to any other TI intellectual property right or to any third party intellectual property right. TI disclaims responsibility for, and you will fully indemnify TI and its representatives against, any claims, damages, costs, losses, and liabilities arising out of your use of these resources.

TI's products are provided subject to TI's Terms of Sale ([www.ti.com/legal/termsofsale.html](http://www.ti.com/legal/termsofsale.html)) or other applicable terms available either on [ti.com](http://ti.com) or provided in conjunction with such TI products. TI's provision of these resources does not expand or otherwise alter TI's applicable warranties or warranty disclaimers for TI products.

Mailing Address: Texas Instruments, Post Office Box 655303, Dallas, Texas 75265  
Copyright © 2019, Texas Instruments Incorporated