

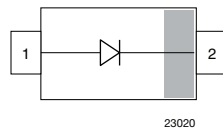

Standard Recovery Rectifier, High Voltage Surface-Mount

eSMP® Series

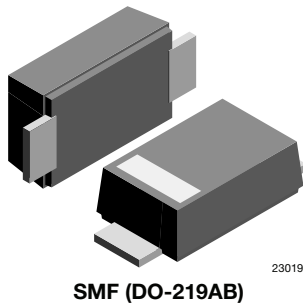

FEATURES

- For surface mounted applications
- Low profile package
- Ideal for automated placement
- Glass passivated
- High temperature soldering: 260 °C / 10 s at terminals
- Wave and reflow solderable
- Compatible to SOD-123W package case outline or SOD-123F and SOD-123FL
- Material categorization: for definitions of compliance please see www.vishay.com/doc?99912



RoHS COMPLIANT

MECHANICAL DATA

Case: SMF (DO-219AB)

Polarity: band denotes cathode end

Weight: approx. 15 mg

Packaging codes / options:

GS18/10K per 13" reel (8 mm tape), MOQ = 50K

GS08/3K per 7" reel (8 mm tape), MOQ = 30K

Circuit configuration: single

LINKS TO ADDITIONAL RESOURCES



PARTS TABLE			
PART	ORDERING CODE	MARKING	REMARKS
S1FLB	S1FLB-GS18 or S1FLB-GS08	FB	Tape and reel
S1FLD	S1FLD-GS18 or S1FLD-GS08	FD	Tape and reel
S1FLG	S1FLG-GS18 or S1FLG-GS08	FG	Tape and reel
S1FLJ	S1FLJ-GS18 or S1FLJ-GS08	FJ	Tape and reel
S1FLK	S1FLK-GS18 or S1FLK-GS08	FK	Tape and reel
S1FLM	S1FLM-GS18 or S1FLM-GS08	FM	Tape and reel

ABSOLUTE MAXIMUM RATINGS (T _{amb} = 25 °C, unless otherwise specified)					
PARAMETER	TEST CONDITION	PART	SYMBOL	VALUE	UNIT
Maximum repetitive peak reverse voltage		S1FLB	V _{RRM}	100	V
		S1FLD	V _{RRM}	200	V
		S1FLG	V _{RRM}	400	V
		S1FLJ	V _{RRM}	600	V
		S1FLK	V _{RRM}	800	V
		S1FLM	V _{RRM}	1000	V
Maximum RMS voltage		S1FLB	V _{RMS}	70	V
		S1FLD	V _{RMS}	140	V
		S1FLG	V _{RMS}	280	V
		S1FLJ	V _{RMS}	420	V
		S1FLK	V _{RMS}	560	V
		S1FLM	V _{RMS}	700	V
Maximum DC blocking voltage		S1FLB	V _{DC}	100	V
		S1FLD	V _{DC}	200	V
		S1FLG	V _{DC}	400	V
		S1FLJ	V _{DC}	600	V
		S1FLK	V _{DC}	800	V
		S1FLM	V _{DC}	1000	V
Maximum average forward rectified current	T _L = 75 °C		I _{F(AV)}	1.5	A
	T _A = 65 °C ⁽¹⁾		I _{F(AV)}	0.7	A
Peak forward surge current 8.3 ms single half sine-wave	T _L = 25 °C		I _{FSM}	22	A

Note

⁽¹⁾ Averaged over any 20 ms period



THERMAL CHARACTERISTICS ($T_{amb} = 25\text{ }^{\circ}\text{C}$, unless otherwise specified)				
PARAMETER	TEST CONDITION	SYMBOL	VALUE	UNIT
Thermal resistance junction to ambient air ⁽¹⁾		R_{thJA}	180	K/W
Operating junction and storage temperature range		T_j, T_{stg}	-55 to +150	$^{\circ}\text{C}$

Note

⁽¹⁾ Mounted on epoxy substrate with 3 mm x 3 mm Cu pads ($\geq 40\text{ }\mu\text{m}$ thick)

ELECTRICAL CHARACTERISTICS ($T_{amb} = 25\text{ }^{\circ}\text{C}$, unless otherwise specified)								
PARAMETER	TEST CONDITION	PART	SYMBOL	MIN.	TYP.	MAX.	UNIT	
Maximum instantaneous forward voltage	1 A ⁽¹⁾	S1FLB	V_F			1.1	V	
		S1FLD	V_F			1.1	V	
		S1FLG	V_F			1.1	V	
		S1FLJ	V_F			1.1	V	
		S1FLK	V_F			1.1	V	
		S1FLM	V_F			1.1	V	
Maximum DC reverse current at rated DC blocking voltage	$T_A = 25\text{ }^{\circ}\text{C}$	S1FLB	I_R			10	μA	
		S1FLD	I_R			10	μA	
		S1FLG	I_R			10	μA	
		S1FLJ	I_R			10	μA	
		S1FLK	I_R			10	μA	
		S1FLM	I_R			10	μA	
	$T_A = 125\text{ }^{\circ}\text{C}$	S1FLB	I_R				50	μA
		S1FLD	I_R				50	μA
		S1FLG	I_R				50	μA
		S1FLJ	I_R				50	μA
		S1FLK	I_R				50	μA
		S1FLM	I_R				50	μA
Reverse recovery time	$I_F = 0.5\text{ A}, I_R = 1\text{ A}, I_{rr} = 0.25\text{ A}$	S1FLB	t_{rr}			1800	ns	
		S1FLD	t_{rr}			1800	ns	
		S1FLG	t_{rr}			1800	ns	
		S1FLJ	t_{rr}			1800	ns	
		S1FLK	t_{rr}			1800	ns	
		S1FLM	t_{rr}			1800	ns	
Typical capacitance	4 V, 1 MHz	S1FLB	C_j		4		pF	
		S1FLD	C_j		4		pF	
		S1FLG	C_j		4		pF	
		S1FLJ	C_j		4		pF	
		S1FLK	C_j		4		pF	
		S1FLM	C_j		4		pF	

Note

⁽¹⁾ Pulse test: 300 μs pulse width, 1 % duty cycle



TYPICAL CHARACTERISTICS ($T_{amb} = 25\text{ }^{\circ}\text{C}$, unless otherwise specified)

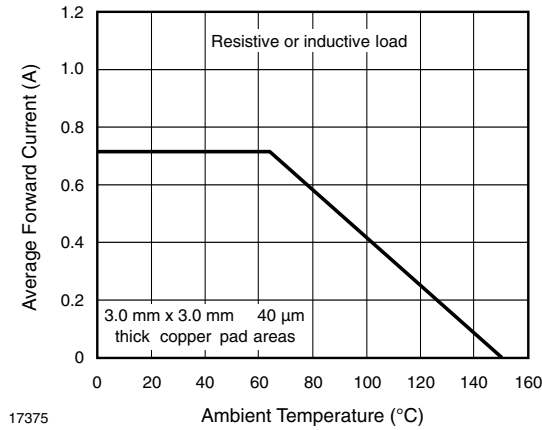

Fig. 1 - Forward Current Derating Curve

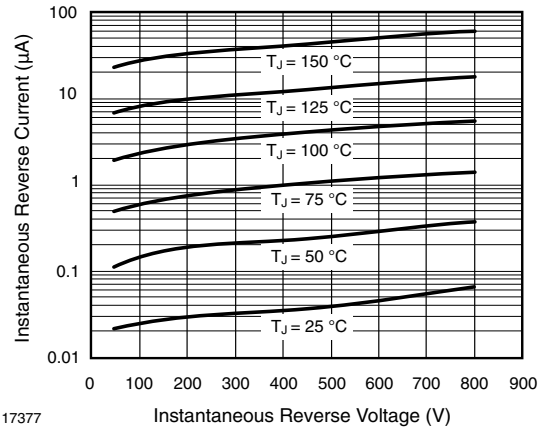

Fig. 3 - Typical Instantaneous Reverse Characteristics

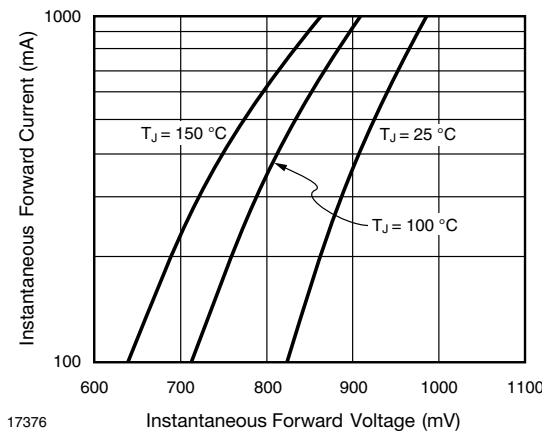

Fig. 2 - Typical Instantaneous Forward Characteristics

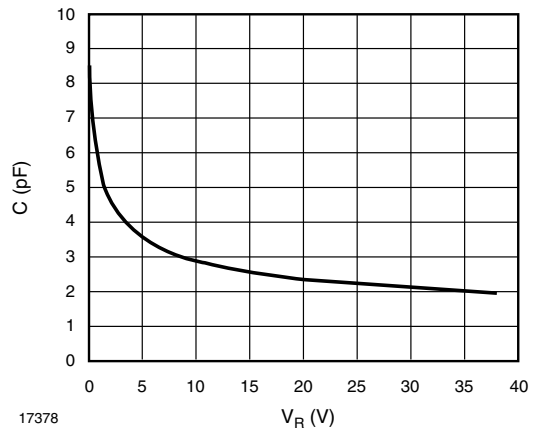
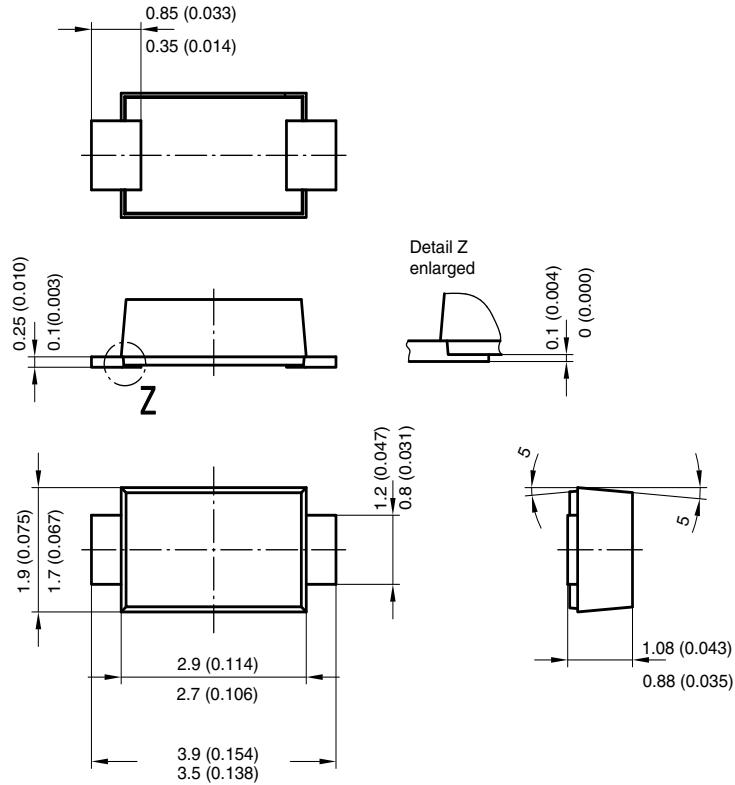

Fig. 4 - Capacitance vs. Reverse Voltage



PACKAGE DIMENSIONS in millimeters (inches): SMF (DO-219AB)



Foot print recommendation:

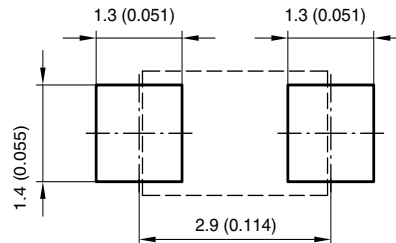

Created - Date: 15. February 2005
 Rev. 3 - Date: 13. March 2007
 Document no.: S8-V-3915.01-001 (4)
 17247

ORIENTATION IN CARRIER TAPE - SMF

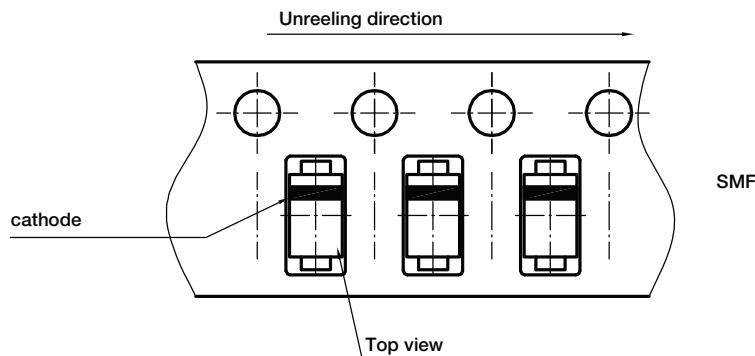

Document no.: S8-V-3717.02-003 (4)
 Created - Date: 09. Feb. 2010
 22670



Disclaimer

ALL PRODUCT, PRODUCT SPECIFICATIONS AND DATA ARE SUBJECT TO CHANGE WITHOUT NOTICE TO IMPROVE RELIABILITY, FUNCTION OR DESIGN OR OTHERWISE.

Vishay Intertechnology, Inc., its affiliates, agents, and employees, and all persons acting on its or their behalf (collectively, "Vishay"), disclaim any and all liability for any errors, inaccuracies or incompleteness contained in any datasheet or in any other disclosure relating to any product.

Vishay makes no warranty, representation or guarantee regarding the suitability of the products for any particular purpose or the continuing production of any product. To the maximum extent permitted by applicable law, Vishay disclaims (i) any and all liability arising out of the application or use of any product, (ii) any and all liability, including without limitation special, consequential or incidental damages, and (iii) any and all implied warranties, including warranties of fitness for particular purpose, non-infringement and merchantability.

Statements regarding the suitability of products for certain types of applications are based on Vishay's knowledge of typical requirements that are often placed on Vishay products in generic applications. Such statements are not binding statements about the suitability of products for a particular application. It is the customer's responsibility to validate that a particular product with the properties described in the product specification is suitable for use in a particular application. Parameters provided in datasheets and / or specifications may vary in different applications and performance may vary over time. All operating parameters, including typical parameters, must be validated for each customer application by the customer's technical experts. Product specifications do not expand or otherwise modify Vishay's terms and conditions of purchase, including but not limited to the warranty expressed therein.

Except as expressly indicated in writing, Vishay products are not designed for use in medical, life-saving, or life-sustaining applications or for any other application in which the failure of the Vishay product could result in personal injury or death. Customers using or selling Vishay products not expressly indicated for use in such applications do so at their own risk. Please contact authorized Vishay personnel to obtain written terms and conditions regarding products designed for such applications.

No license, express or implied, by estoppel or otherwise, to any intellectual property rights is granted by this document or by any conduct of Vishay. Product names and markings noted herein may be trademarks of their respective owners.