



# 80×80×15 mm

**San Ace 80 9GA type** Low Power Consumption Fan Model 9GA0812H7001 is not certified.

## General Specifications

- Material ..... Frame: Plastic (Flammability: UL 94V-0), Impeller: Plastic (Flammability: UL 94V-0)
- Expected life ..... See the table below. (L10 life: 90% survival rate for continuous operation in free air at 60°C, rated voltage)
- Motor protection function ..... Locked rotor burnout protection, Reverse polarity protection  
For details, please refer to p. 529.
- Dielectric strength ..... 50/60 Hz, 500 VAC, for 1 minute (between lead wire conductors and frame)
- Insulation resistance ..... 10 MΩ or more with a 500 VDC megger (between lead wire conductors and frame)
- Sound pressure level (SPL) ..... At 1 m away from the air inlet
- Storage temperature ..... -30 to +70°C (Non-condensing)
- Lead wire ..... ⊕Red ⊖Black (Sensor) Yellow (Control) Brown  
(For models without PWM control function, there is no speed control wiring.)
- Mass ..... 65 g

## Specifications

The models listed below **have ribs and pulse sensors with PWM control function.**

Model no.	Rated voltage [V]	Operating voltage range [V]	PWM duty cycle* [%]	Rated current [A]	Rated input [W]	Rated speed [min <sup>-1</sup> ]	Max. airflow [m <sup>3</sup> /min] [CFM]	Max. static pressure [Pa] [inchH <sub>2</sub> O]	SPL [dB (A)]	Operating temperature [°C]	Expected life [h]
9GA0812P7G001	12	10.2 to 13.8	100	0.29	3.48	6100	1.44 50.9	84.0 0.34	41	-20 to +70	40000/60°C (70000/40°C)
9GA0812P7S001			100	0.17	2.04	5000	1.18 41.7	56.4 0.23	37		
9GA0824P7G001	24	20.4 to 27.6	100	0.13	3.12	6100	1.44 50.9	84.0 0.34	41		
9GA0824P7S001			100	0.08	1.92	5000	1.18 41.7	56.4 0.23	37		

\* PWM frequency: 25 kHz. Fan does not rotate when PWM duty cycle is 0%.

The models listed below **have ribs and pulse sensors.**

Model no.	Rated voltage [V]	Operating voltage range [V]	Rated current [A]	Rated input [W]	Rated speed [min <sup>-1</sup> ]	Max. airflow [m <sup>3</sup> /min] [CFM]	Max. static pressure [Pa] [inchH <sub>2</sub> O]	SPL [dB (A)]	Operating temperature [°C]	Expected life [h]
9GA0812H7001	12	6 to 13.2	0.09	1.08	3800	0.89 31.4	32.6 0.13	29	-20 to +70	40000/60°C (70000/40°C)
9GA0824H7001	24	12 to 26.4	0.05	1.2	3800	0.89 31.4	32.6 0.13	29		

Other sensor specifications are available as options. Refer to the index (p. 552).

## Airflow - Static Pressure Characteristics / PWM Duty - Speed Characteristics Example

**9GA0812P7G001** With pulse sensor with PWM control function

PWM duty cycle

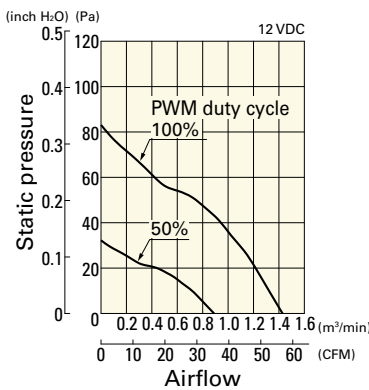

Operating voltage range

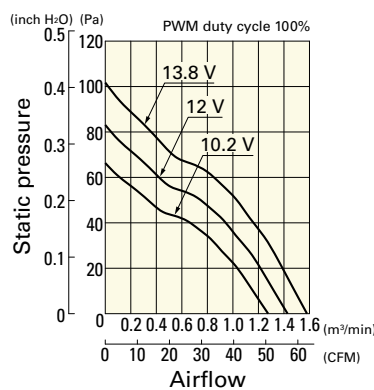

PWM duty - Speed characteristics example

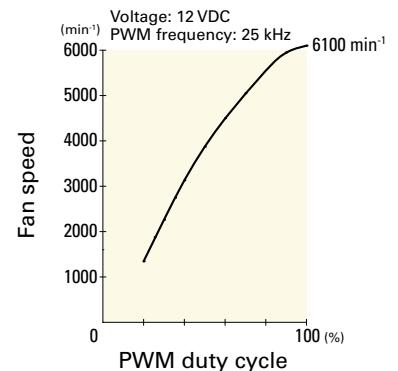

# Airflow - Static Pressure Characteristics / PWM Duty - Speed Characteristics Example

**9GA0812P7S001** With pulse sensor with PWM control function

PWM duty cycle

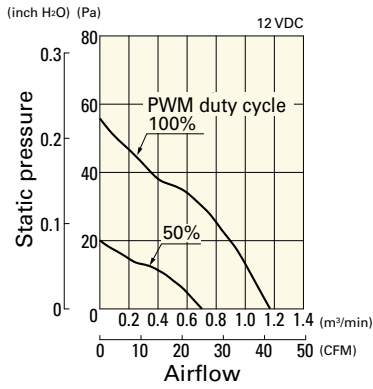

Operating voltage range

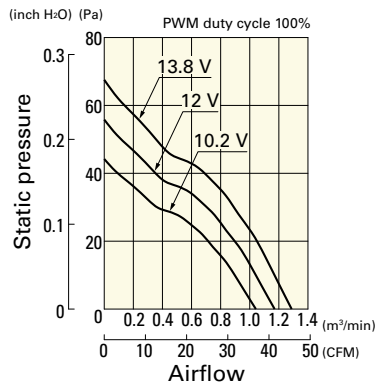

PWM duty - Speed characteristics example

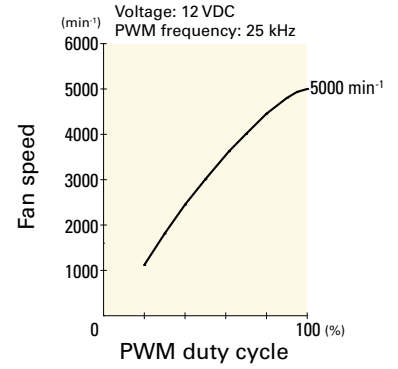

**9GA0824P7G001** With pulse sensor with PWM control function

PWM duty cycle

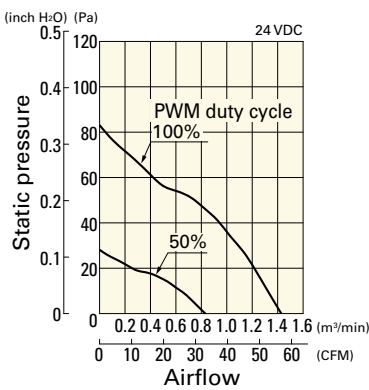

Operating voltage range

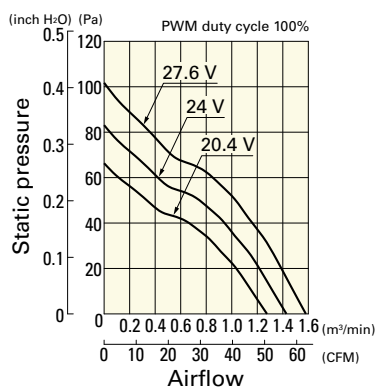

PWM duty - Speed characteristics example

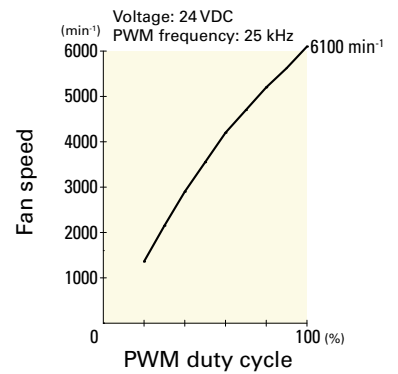

**9GA0824P7S001** With pulse sensor with PWM control function

PWM duty cycle

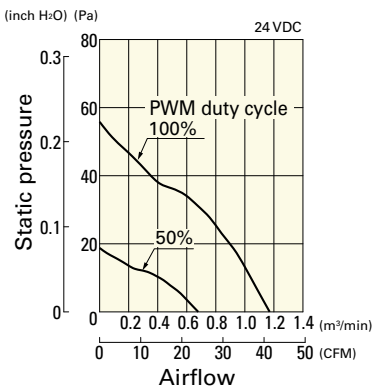

Operating voltage range

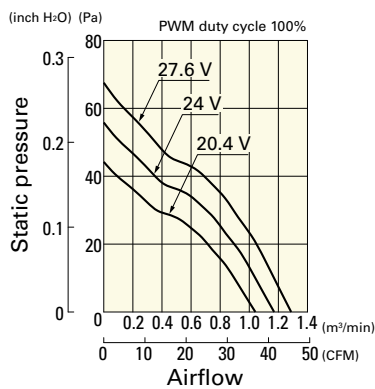

PWM duty - Speed characteristics example

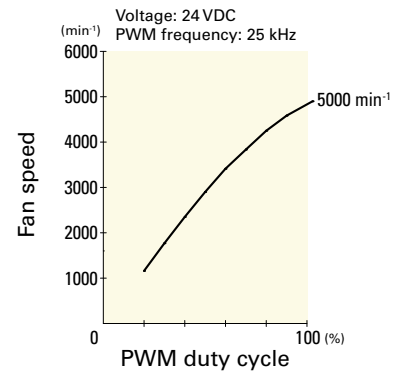

**9GA0812H7001** With pulse sensor

Operating voltage range

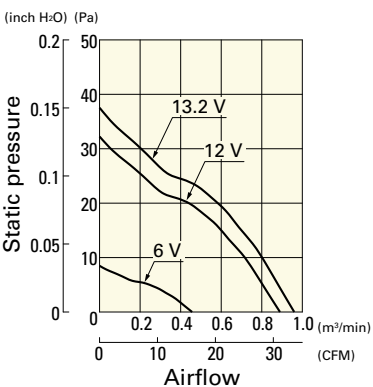

**9GA0824H7001** With pulse sensor

Operating voltage range

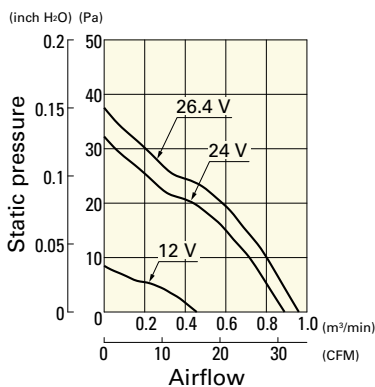

**Dimensions (unit: mm)** (With pulse sensor with PWM control function)

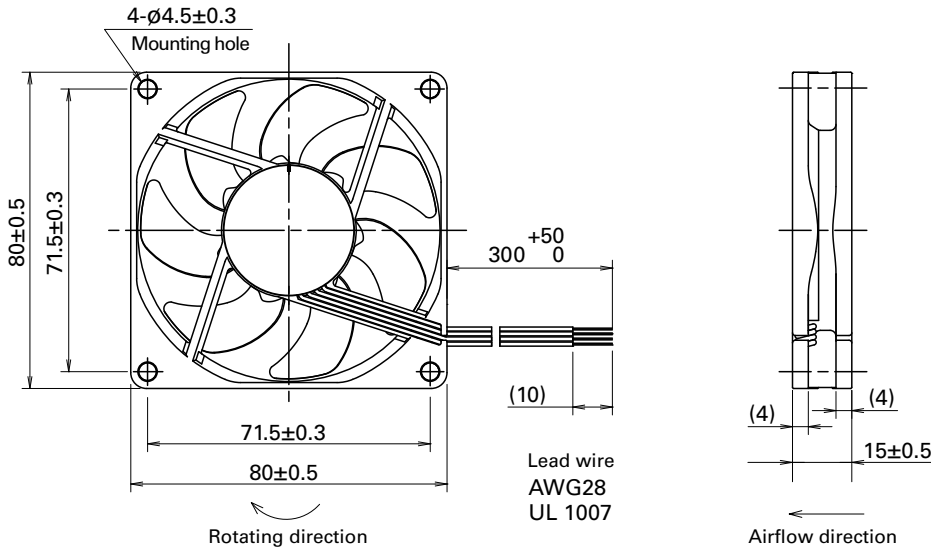

**Reference Dimensions of Mounting Holes and Vent Opening (unit: mm)**

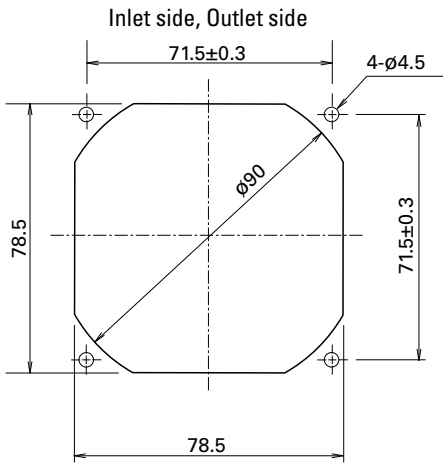

**Options**

**Finger guards**

page: p. 513

Model no.: 109-049C, 109-049E, 109-049H

**Resin finger guards**

page: p. 520

Model no.: 109-1002G

**Resin filter kits**

page: p. 521

Model no.: 109-1002F13 (13PPI), 109-1002F20 (20PPI),  
109-1002F30 (30PPI), 109-1002F40 (40PPI)

# Mouser Electronics

Authorized Distributor

Click to View Pricing, Inventory, Delivery & Lifecycle Information:

## Sanyo Denki:

[9GA0824P7G001](#) [9GA0812P7G001](#) [9GA0824P7S001](#) [9GA0824H7001](#) [9GA0812P7S001](#) [9GA0812H7001](#)  
[9GA0824H7002](#) [9GA0824H7D001](#) [9GA0812H7D001](#) [9GA0824G7D001](#)