

PLEASE CHECK WWW.MOLEX.COM FOR LATEST PART INFORMATION

Part Number: [0444752411](#)
Status: **Active**
Overview: [minifit_plus_hcs](#)
Description: 4.20mm Pitch Mini-Fit® HCS Receptacle Header, Dual Row, Vertical, Blind Mating, with Snap-in Plastic Pegs, 24 Circuits

Documents:

[3D Model](#) [Product Specification PS-44476-001 \(PDF\)](#)
[Drawing \(PDF\)](#) [RoHS Certificate of Compliance \(PDF\)](#)

Agency Certification

CSA LR19980
 UL E29179

General

Product Family PCB Receptacles
 Series [44475](#)
 Application Board-to-Board, Power, Wire-to-Board
 Comments Solder Type|With Pegs
 Overview [minifit_plus_hcs](#)
 Product Name Mini-Fit® HCS

Physical

Circuits (Loaded) 24
 Color - Resin Natural
 Durability (mating cycles max) 30
 Flammability 94V-2
 Glow-Wire Compliant No
 Material - Metal Copper
 Material - Plating Mating Tin
 Material - Plating Termination Tin
 Material - Resin Nylon
 Number of Rows 2
 Orientation Vertical
 PCB Locator Yes
 PCB Retention Yes
 PCB Thickness - Recommended 1.60mm
 Packaging Type Tray
 Pitch - Mating Interface 4.20mm
 Plating min - Mating 2.540µm
 Plating min - Termination 2.540µm
 Polarized to PCB Yes
 Surface Mount Compatible (SMC) No
 Temperature Range - Operating -40°C to +105°C
 Termination Interface: Style Through Hole

Electrical

Current - Maximum per Contact 11A
 Voltage - Maximum 600V

Solder Process Data

Duration at Max. Process Temperature (seconds) 5
 Lead-free Process Capability Wave Capable (TH only)
 Max. Cycles at Max. Process Temperature 1
 Process Temperature max. C 240

Material Info

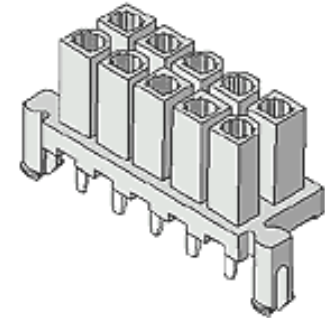

Series

image - Reference only

EU RoHS

ELV and RoHS Compliant
REACH SVHC Contains SVHC: No
Low-Halogen Status Low-Halogen

China RoHS



Need more information on product environmental compliance?

Email productcompliance@molex.com
 For a multiple part number RoHS Certificate of Compliance, [click here](#)

Please visit the [Contact Us](#) section for any non-product compliance questions.

Search Parts in this Series

[44475Series](#)

Mates With

Mini-Fit® SMC 44068 , 43810 , Mini-Fit® BMI Header 42404 , Mini-Fit® HCS [44474](#) , Mini-Fit® BMI Plug Housing [42475](#)

Old Part Number

A-44475-2411

Reference - Drawing Numbers

Product Specification

PS-44476-001, RPS-44476-001

Sales Drawing

SDA-44475-****

This document was generated on 01/19/2012

PLEASE CHECK WWW.MOLEX.COM FOR LATEST PART INFORMATION

Mouser Electronics

Authorized Distributor

Click to View Pricing, Inventory, Delivery & Lifecycle Information:

[Molex:](#)

[44475-2411](#)