

2 x 75W multifunction dual-bridge power amplifier with integrated digital diagnostics

Features

- Multipower bcd technology
- MOSFET output power stage
- DMOS power output
- New high-efficiency (class AB)
- Single-channel 1Ω driving capability
- High output power capability 2x28 W/4 Ω @ 14.4 V, 1 kHz, 10 % THD
- Max. output power 2x75 W/2 Ω, 1x150 W/1 Ω
- Single-channel 1 Ω driving capability
- 84 W undistorted power
- Full I²C bus driving with 4 address possibilities:
 - Standby
 - Play/mute
 - Gain 12/26 dB
 - Full digital diagnostic (AC and DC loads)
- Possibility to disable the I²C bus
- Differential inputs
- Full fault protection
- DC offset detection
- Two independent short circuit protections
- Diagnostic on clipping detector with selectable threshold (2 % / 10 %)
- Clipping detector as diagnostic pin when I²C bus is disabled
- Standby/mute pins
- ESD protection

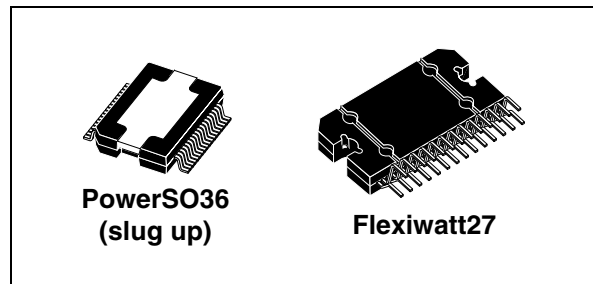

Description

The TDA7575B is a new MOSFET dual bridge amplifier specially intended for car radio applications. Thanks to the DMOS output stage the TDA7575B has a very low distortion allowing a clear powerful sound.

Among the features, its superior efficiency performance coming from the internal exclusive structure, makes it the most suitable device to simplify the thermal management in high power sets. The dissipated output power under average listening condition is in fact reduced up to 50% when compared to the level provided by conventional class AB solutions.

This device is equipped with a full diagnostic array that communicates the status of each speaker through the I²C bus. The TDA7575B has also the possibility of driving loads down to 1Ω paralleling the outputs into a single channel. It is also possible to disable the I²C and control the TDA7575B by means of the usual standby and mute pins.

Table 1. Device summary

Order code	Package	Packing
TDA7575B	Flexiwatt27	Tube
TDA7575BPD	PowerSO36 (slug up)	Tube
TDA7575BPDTR	PowerSO36 (slug up)	Tape and reel

Contents

- 1 Block and pins diagrams 5**
- 2 Electrical specifications 6**
 - 2.1 Absolute maximum ratings 6
 - 2.2 Thermal data 6
 - 2.3 Electrical characteristics 6
- 3 Electrical characteristics curves 11**
- 4 Application circuits 15**
- 5 I2C bus interface 16**
 - 5.1 Data validity 16
 - 5.2 Start and stop conditions 16
 - 5.3 Byte format 16
 - 5.4 Acknowledge 16
 - 5.5 1 W capability setting 17
 - 5.6 I2C abilitation setting 18
- 6 Software specifications 19**
 - 6.1 Examples of bytes sequence 22
- 7 Diagnostics functional description 23**
 - 7.1 Turn-on diagnostic 23
 - 7.2 Permanent diagnostics 25
 - 7.3 Output DC offset detection 26
 - 7.4 AC diagnostic 26
 - 7.5 Multiple faults 27
 - 7.6 Faults availability 28
 - 7.7 I2C programming/reading sequences 28
- 8 Package information 29**
- 9 Revision history 31**

List of tables

Table 1.	Device summary	1
Table 2.	Absolute maximum ratings	6
Table 3.	Thermal data	6
Table 4.	Electrical characteristics	6
Table 5.	Address selection	19
Table 6.	IB1	19
Table 7.	IB2	20
Table 8.	DB1	20
Table 9.	DB2	21
Table 10.	Double fault table for turn-on diagnostic	28
Table 11.	Document revision history	31

List of figures

Figure 1.	Block diagram	5
Figure 2.	Pins connection diagram (top view)	5
Figure 3.	Quiescent drain current vs. supply voltage	11
Figure 4.	Output power vs. supply voltage	11
Figure 5.	Output power vs. supply voltage	11
Figure 6.	Output power vs. supply voltage	11
Figure 7.	Distortion vs. output power	11
Figure 8.	Distortion vs. output power	11
Figure 9.	Distortion vs. output power	12
Figure 10.	Distortion vs. output power	12
Figure 11.	Distortion vs. output power	12
Figure 12.	Distortion vs. frequency	12
Figure 13.	Distortion vs. output voltage (LD mode)	12
Figure 14.	Cross talk vs. frequency	12
Figure 15.	Cross talk vs. frequency (LD mode)	13
Figure 16.	CMRR vs. frequency	13
Figure 17.	Output attenuation vs. supply voltage (vs. dependent muting)	13
Figure 18.	Output attenuation vs. mute pin voltage	13
Figure 19.	Power dissipation vs. output power (4Ω - SINE)	13
Figure 20.	Power dissipation vs. output power (2Ω - SINE)	13
Figure 21.	Power dissipation vs. average output power (Audio program simulation, 4Ω)	14
Figure 22.	Power dissipation vs. average output power (Audio program simulation, 2Ω)	14
Figure 23.	ITU R-ARM frequency response, weighting filter for transient pop	14
Figure 24.	Application circuit (TDA7575B)	15
Figure 25.	Application circuit (TDA7575BPD)	15
Figure 26.	Data validity on the I2C bus	16
Figure 27.	Timing diagram on the I2C bus	17
Figure 28.	Timing acknowledge clock pulse	17
Figure 29.	Turn-on diagnostic: working principle	23
Figure 30.	SVR and output behavior - case 1: without turn-on diagnostic	23
Figure 31.	SVR and output pin behavior - case 2: with turn-on diagnostic	24
Figure 32.	Short circuit detection thresholds	24
Figure 33.	Load detection thresholds - high gain setting	24
Figure 34.	Load detection thresholds - high gain setting	24
Figure 35.	Restart timing without diagnostic enable (permanent)	25
Figure 36.	Restart timing with diagnostic enable (permanent)	25
Figure 37.	Current detection high: load impedance Z _L vs. output peak voltage	27
Figure 38.	Current detection low: load impedance Z _L vs. output peak voltage	27
Figure 39.	PowerSO36 (slug up) mechanical data and package dimensions	29
Figure 40.	Flexiwatt27 (vertical) mechanical data and package dimensions	30

1 Block and pins diagrams

Figure 1. Block diagram

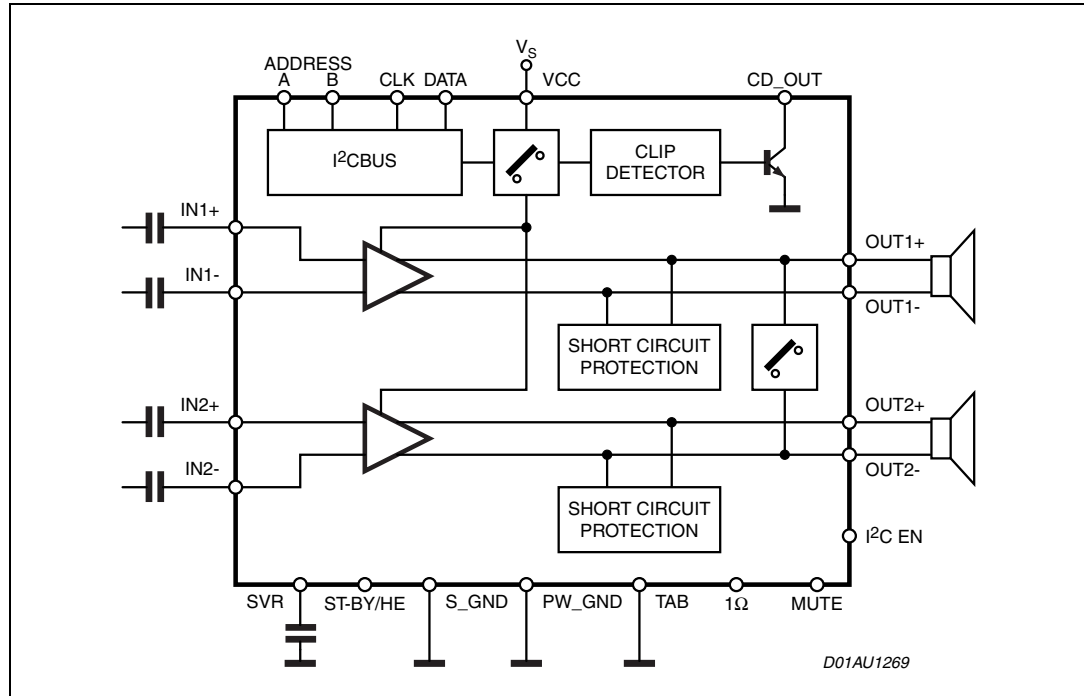
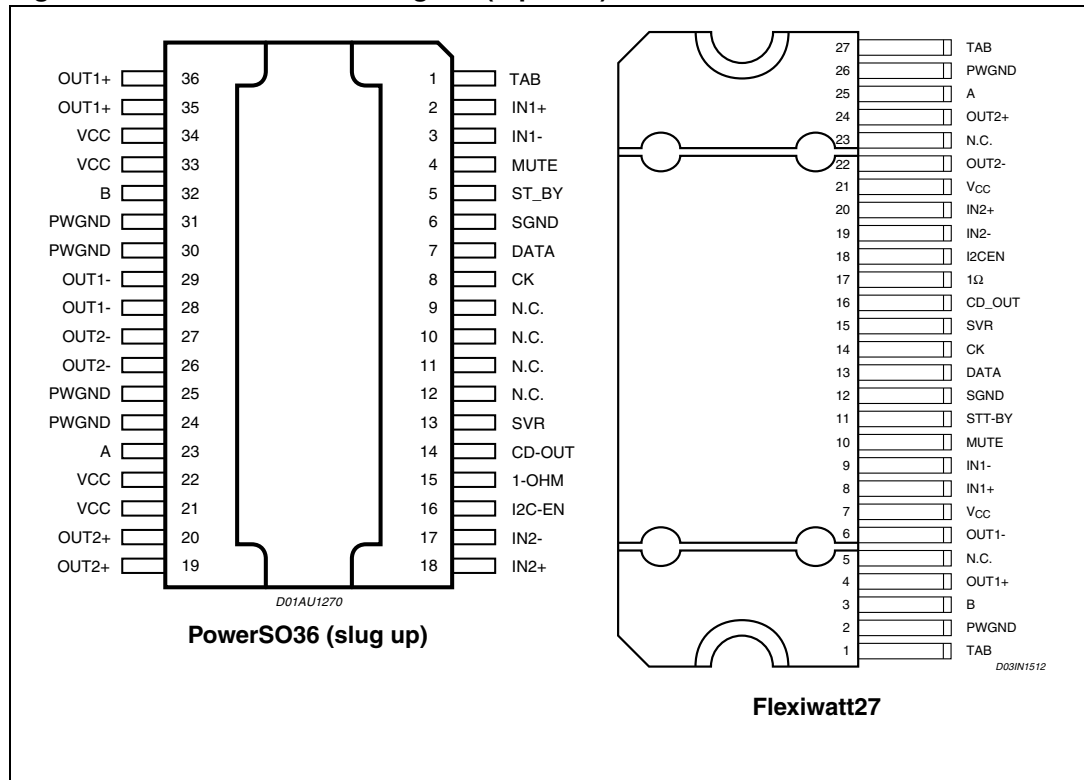

Figure 2. Pins connection diagram (top view)



2 Electrical specifications

2.1 Absolute maximum ratings

Table 2. Absolute maximum ratings

Symbol	Parameter	Value	Unit
V_{op}	Operating supply voltage	18	V
V_S	DC supply voltage	28	V
V_{peak}	Peak supply voltage (for $t = 50$ ms)	50	V
V_{CK}	CK pin voltage	6	V
V_{DATA}	Data pin voltage	6	V
I_O	Output peak current (not repetitive $t = 100$ ms)	8	A
I_O	Output peak current (repetitive $f > 10$ Hz)	6	A
P_{tot}	Power dissipation $T_{case} = 70$ °C	86	W
T_{stg}, T_j	Storage and junction temperature	-55 to 150	°C

2.2 Thermal data

Table 3. Thermal data

Symbol	Parameter	PowerSO36	Flexiwatt 27	Unit
$R_{th j-case}$	Thermal resistance junction-to-case	Max 1	1	°C/W

2.3 Electrical characteristics

$V_S = 14.4$ V; $f = 1$ kHz; $R_L = 4$ Ω ; $T_{amb} = 25$ °C unless otherwise specified.

Table 4. Electrical characteristics

Symbol	Parameter	Test condition	Min.	Typ.	Max.	Unit
Power amplifier						
V_S	Supply voltage range	-	8	-	18	V
I_d	Total quiescent drain current	-	50	130	200	mA
P_o	Output power	Max. power ⁽¹⁾	35	40	-	W
		THD = 10 %	25	28	-	W
		THD = 1 %; BTL mode		22		
		$R_L = 2$ Ω ; THD 10 % $R_L = 2$ Ω ; THD 1 % $R_L = 2$ Ω ; Max. power ⁽¹⁾	45 70	50 75	-	W

Table 4. Electrical characteristics (continued)

Symbol	Parameter	Test condition	Min.	Typ.	Max.	Unit
P_o	Output power	Single channel configuration (1 Ω pin > 2.5 V); $R_L = 1 \Omega$; THD 3 % Max. power ⁽¹⁾	80 140	84 150	-	W
THD	Total harmonic distortion	$P_o = 1-12$ W; STD mode HE mode; $P_o = 1-2$ W HE mode; $P_o = 4-8$ W	-	0.03 0.03 0.5	0.1 0.1	%
		$P_o = 1-12$ W, $f = 10$ kHz	-	0.15	0.5	%
		$R_L = 2$; HE mode; $P_o = 3$ W	-	0.03	0.5	%
		Single channel configuration (1 Ω pin > 2.5 V); $R_L = 1$; $P_o = 4-30$ W	-	0.02	0.1	%
C_T	Cross talk	$R_g = 600 \Omega$; $P_o = 1$ W	60	75	-	dB
R_{IN}	Input impedance	-	60	100	130	k Ω
G_{V1}	Voltage gain 1 (default)	-	25	26	27	dB
ΔG_{V1}	Voltage gain match 1	-	-1	0	1	dB
G_{V2}	Voltage gain 2	-	11	12	13	dB
ΔG_{V2}	Voltage gain match 2	-	-1	0	1	dB
E_{IN1}	Output noise voltage gain 1	$R_g = 600 \Omega$; $G_v = 26$ dB filter 20 to 22 kHz	-	40	60	μ V
E_{IN2}	Output noise voltage gain 2	$R_g = 600 \Omega$; $G_v = 12$ dB filter 20 to 22 kHz	-	15	25	μ V
SVR	Supply voltage rejection	$f = 100$ Hz to 10 kHz; $V_r = 1$ Vpk; $R_g = 600 \Omega$	50	60	-	dB
BW	Power bandwidth	(-3 dB)	100	-	-	KHz
A_{SB}	Standby attenuation	-	90	100	-	dB
I_{SB}	Standby current consumption	$V_{st-by} = 0$ V	-	2	10	μ A
A_M	Mute attenuation	-	80	90	-	dB
V_{OS}	Offset voltage	Mute and play	-45	0	45	mV
V_{AM}	Min. supply mute threshold	-	7	7.5	8	V
CMRR	Input CMRR	$V_{CM} = 1$ Vpk-pk; $R_g = 0 \Omega$	56	60	-	dB
V_{MC}	Maximum common mode input level	$f = 1$ kHz	-	-	1	Vrms
SR	Slew rate	-	1.5	4	-	V/ μ s
ΔV_{OS}	During mute on/off output offset voltage	ITU R-ARM weighted see Figure 23	-10	-	+10	mV
	During standby on/off output offset voltage		-10	-	+10	mV

Table 4. Electrical characteristics (continued)

Symbol	Parameter	Test condition	Min.	Typ.	Max.	Unit
T _{ON}	Turn on delay	D2 (IB1) 0 to 1	-	15	40	ms
T _{OFF}	Turn off delay	D2 (IB1) 1 to 0	-	15	40	ms
V _{OFF}	Standby pin for standby	-	0	-	1.5	V
V _{SB}	Standby pin for standard bridge	-	3.5	-	5	V
V _{HE}	Standby pin for high-efficiency	-	7	-	18	V
I _O	Standby pin current	1.5 < V _{st-by} /HE < 18 V	7	160	200	μA
	Standby pin current	V _{st-by} < 1.5 V	-10	0	10	μA
V _m	Mute pin voltage for mute mode	-	0	-	1.5	V
V _m	Mute pin voltage for play mode	-	3.5	-	18	V
I _m	Mute pin current (standby)	V _{mute} = 0 V, V _{st-by} < 1.5V	-5	0	5	μA
I _m	Mute pin current (operative)	0 V < V _{mute} < 18 V, V _{st-by} > 3.5 V	-	65	100	μA
V _{I2C}	I ² C pin voltage for I ² C disabled	-	0	-	1.5	V
V _{I2C}	I ² C pin voltage for I ² C enabled	-	2.5	-	18	V
I ² C	I ² C pin current (standby)	0V < I ² C EN < 18V, V _{st-by} < 1.5V	-5	0	5	μA
I ² C	I ² C pin current (operative)	I ² C EN <18V, V _{st-by} >3.5V	7	11	15	μA
V _{1Ω}	1 Ω pin voltage for 2ch mode	-	0	-	1.5	V
V _{1Ω}	1 Ω pin voltage for 1 Ω mode	-	2.5	-	18	V
I _{1Ω}	1 Ω pin current (standby)	0 V < 1 Ω <18 V, V _{s-tby} < 1.5 V	-5	0	5	μA
I _{1Ω}	1 Ω pin current (operative)	1 Ω < 18 V, V _{st-by} > 3.5 V	7	11	15	μA
La	A pin voltage	Low logic level	0	-	1.5	V
Ha		High logic level	2.5	-	18	V
Ia	A pin current (standby)	0V < A < 18V, V _{st-by} < 1.5 V	-5	0	5	μA
Ia	A pin current (operative)	A<18V, V _{st-by} > 3.5V	7	11	15	μA
Lb	B pin voltage	Low logic level	0	-	1.5	V
Hb		High logic level	2.5	-	18	V
Ib	B pin current (standby)	0 V < B < 18 V, V _{s-tby} < 1.5 V	-5	0	5	μA
Ib	B pin current (operative)	B < 18 V, V _{st-by} > 3.5 V	7	11	15	μA
T _W	Thermal warning	-	-	150	-	°C
T _{PI}	Thermal protection intervention	-	-	170	-	°C
I _{CDH}	Clip pin high leakage current	CD off, 0 V < V _{CD} < 5.5 V	-15	0	15	μA
I _{CDL}	Clip pin low sink current	CD on; V _{CD} < 300 mV	1			mA
CD	Clip detect THD level	D0 (IB1) = 0	0.8	1.3	2.5	%
		D0 (IB1) = 1	5	10	15	%

(*) Standby pin high enables I²C bus; Standby pin low puts the device in standby condition. (see “prog” for more details)

Table 4. Electrical characteristics (continued)

Symbol	Parameter	Test condition	Min.	Typ.	Max.	Unit
Turn-on diagnostics (Power amplifier mode)						
Pgnd	Short to GND det. (below this limit, the output is considered in short circuit to GND)	Power amplifier in standby condition	-	-	1.2	V
Pvs	Short to Vs det. (above this limit, the output is considered in short circuit to VS)	-	$V_s - 0.9$	-	-	V
Pnop	Normal operation thresholds. (within these limits, the output is considered without faults).	-	1.8	-	$V_s - 1.5$	V
Lsc	Shorted load det.	-	-	-	0.5	Ω
Lop	Open load det.	-	130	-	-	Ω
Lnop	Normal load det.	-	1.5	-	70	Ω
Turn-on diagnostics (Line driver mode)						
Pgnd	Short to GND det. (below this limit, the output is considered in short circuit to GND)	Power amplifier in standby	-	-	1.2	V
Pvs	Short to Vs det. (above this limit, the Output is considered in Short Circuit to VS)		$V_s - 0.9$	-	-	V
Pnop	Normal operation thresholds. (within these limits, the output is considered without faults).		1.8	-	$V_s - 1.5$	V
Lsc	Shorted load det.		-	-	1.5	Ω
Lop	Open load det.		400	-	-	Ω
Lnop	Normal load det.		4.5	-	200	Ω
Permanent diagnostics (Power amplifier mode or line driver mode)						
Pgnd	Short to GND det. (below this limit, the output is considered in short circuit to GND)	Power amplifier in Mute or Play condition, one or more short circuits protection activated	-	-	1.2	V
Pvs	Short to Vs det. (above this limit, the Output is considered in Short Circuit to VS)	-	$V_s - 0.9$	-	-	V
Pnop	Normal operation thresholds. (Within these limits, the Output is considered without faults).	-	1.8	-	$V_s - 1.5$	V
Lsc	Shorted load det.	Pow. amp. mode	-	-	0.5	Ω
		Line driver mode	-	-	1.5	Ω

Table 4. Electrical characteristics (continued)

Symbol	Parameter	Test condition	Min.	Typ.	Max.	Unit
V_O	Offset detection	Power amplifier in play condition AC input signals = 0	± 1.5	± 2	± 2.5	V
I_{NLH}	Normal load current detection	$V_O < (V_S - 5)\mu\text{k IB2 (D0) = 0}$	500	-	-	mA
I_{NLL}	Normal load current detection	$V_O < (V_S - 5)\mu\text{k IB2 (D0) = 1}$	250	-	-	mA
I_{OLH}	Open load current detection	$V_O < (V_S - 5)\mu\text{k IB2 (D0) = 0}$	-	-	250	mA
I_{OLL}	Open load current detection	$V_O < (V_S - 5)\mu\text{k IB2 (D0) = 1}$	-	-	125	mA
I²C bus interface						
f_{SCL}	Clock frequency	-	-	-	400	kHz
V_{IL}	Input low voltage	-	-	-	1.5	V
V_{IH}	Input high voltage	-	2.3	-	-	V

1. Saturated square wave output.

3 Electrical characteristics curves

Figure 3. Quiescent drain current vs. supply voltage

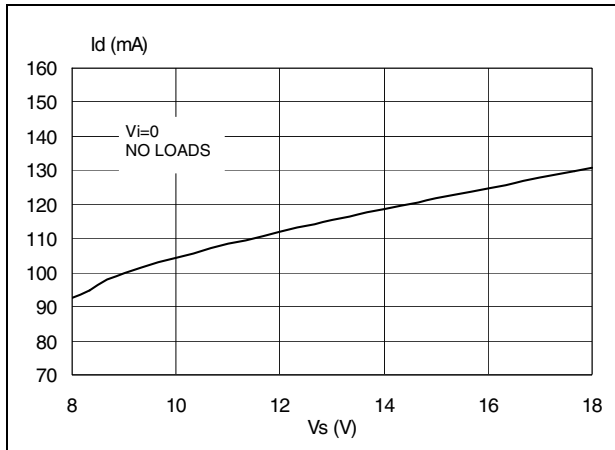

Figure 4. Output power vs. supply voltage

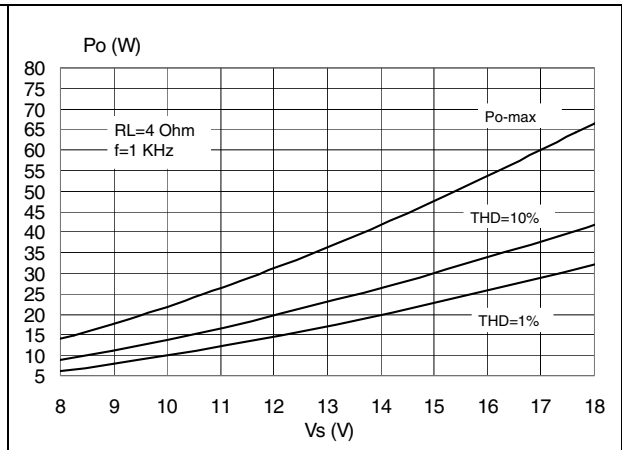

Figure 5. Output power vs. supply voltage

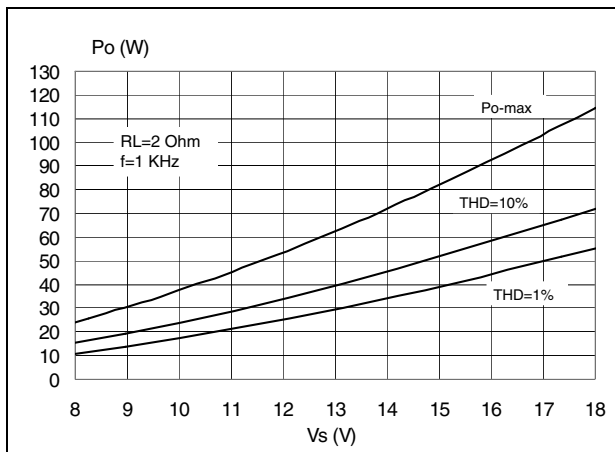

Figure 6. Output power vs. supply voltage

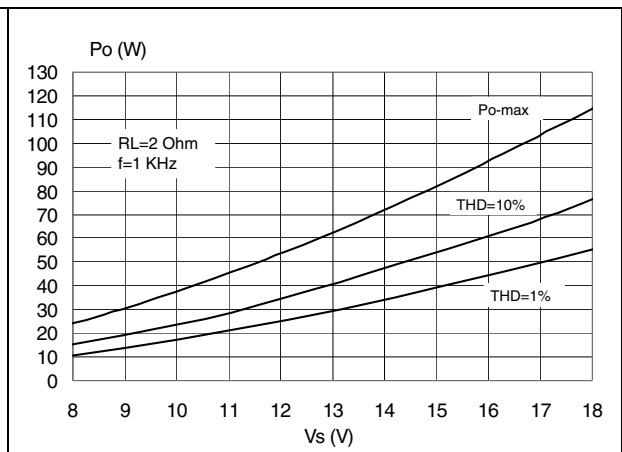

Figure 7. Distortion vs. output power

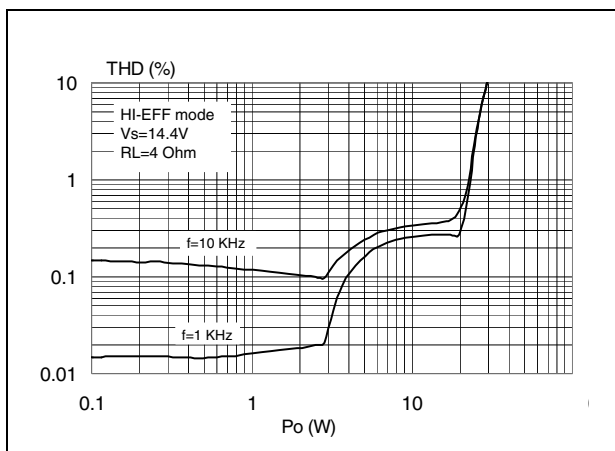

Figure 8. Distortion vs. output power

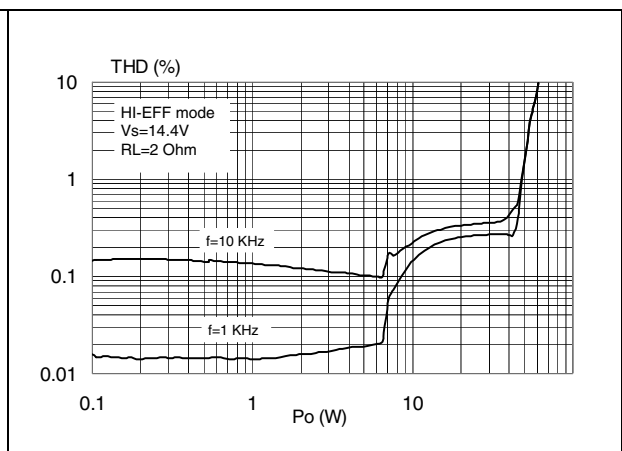

Figure 9. Distortion vs. output power

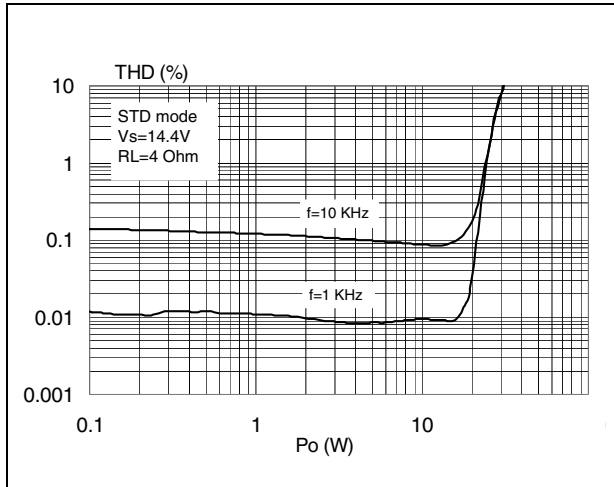

Figure 10. Distortion vs. output power

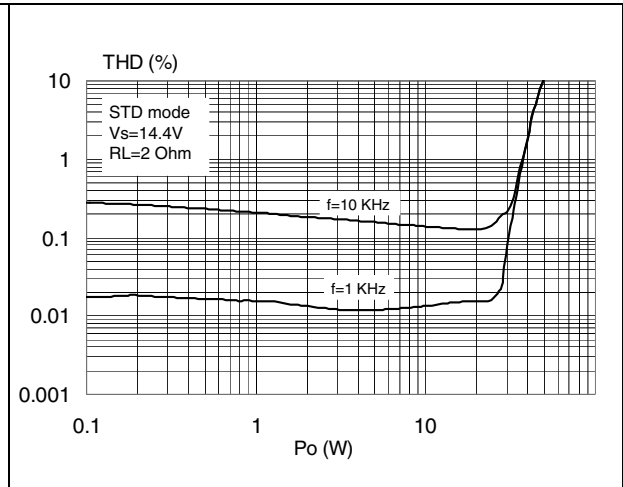

Figure 11. Distortion vs. output power

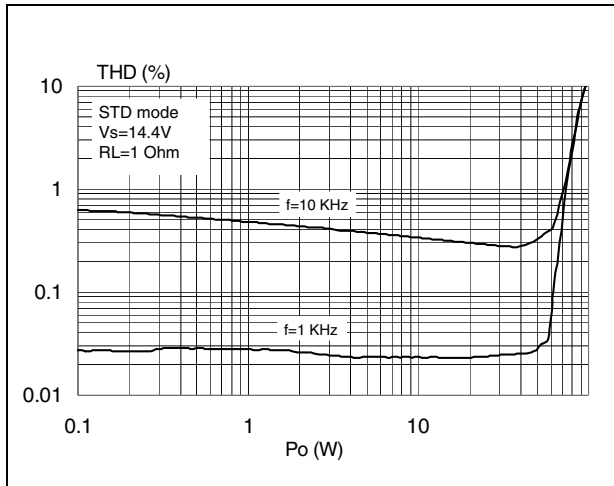

Figure 12. Distortion vs. frequency

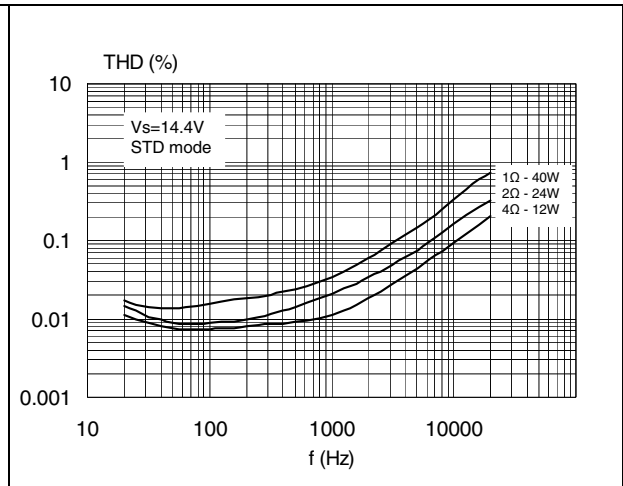

Figure 13. Distortion vs. output voltage (LD mode)

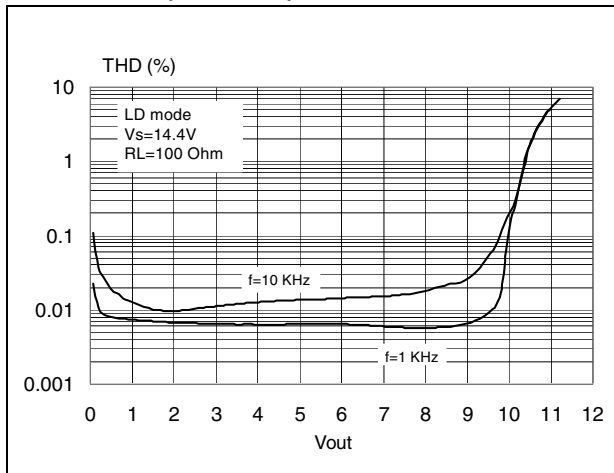

Figure 14. Cross talk vs. frequency

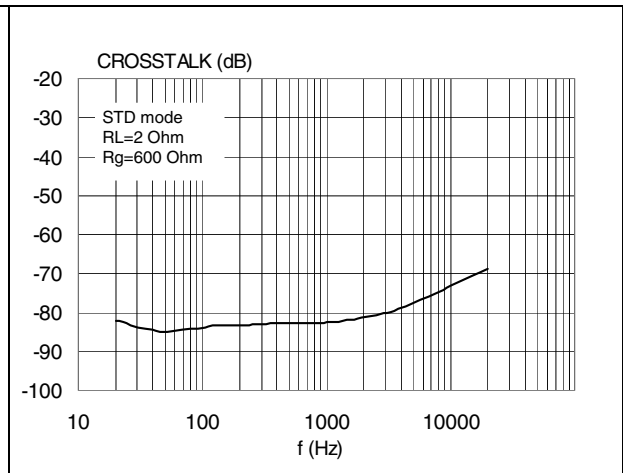

Figure 15. Cross talk vs. frequency (LD mode)

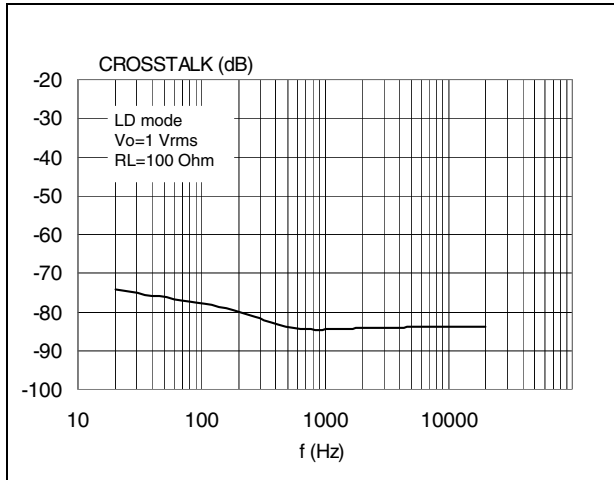

Figure 16. CMRR vs. frequency

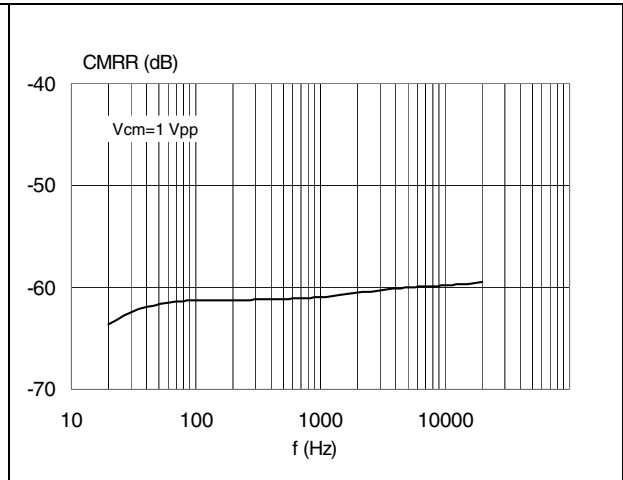

Figure 17. Output attenuation vs. supply voltage (vs. dependent muting)

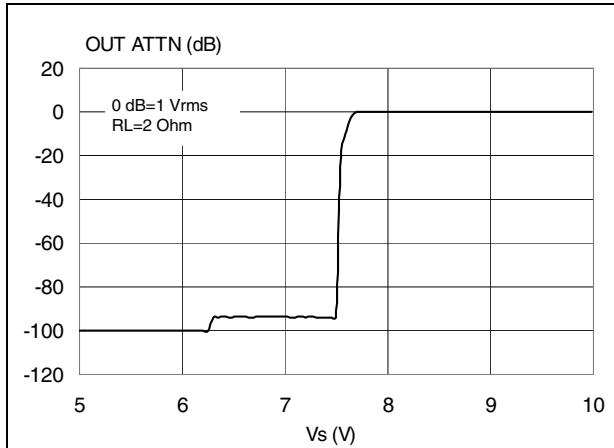

Figure 18. Output attenuation vs. mute pin voltage

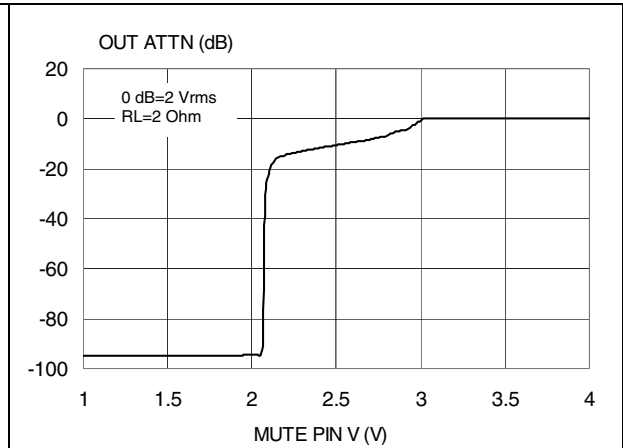

Figure 19. Power dissipation vs. output power (4Ω - SINE)

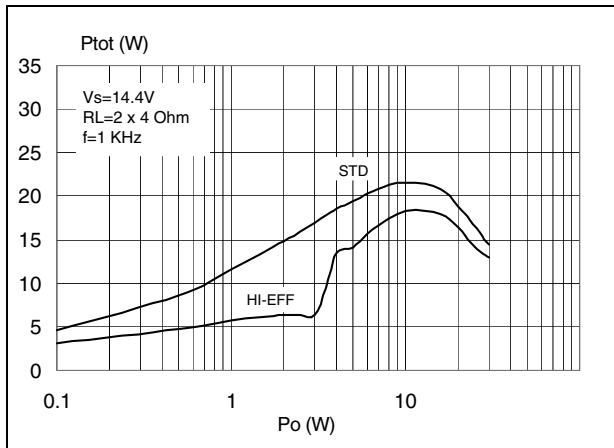

Figure 20. Power dissipation vs. output power (2Ω - SINE)

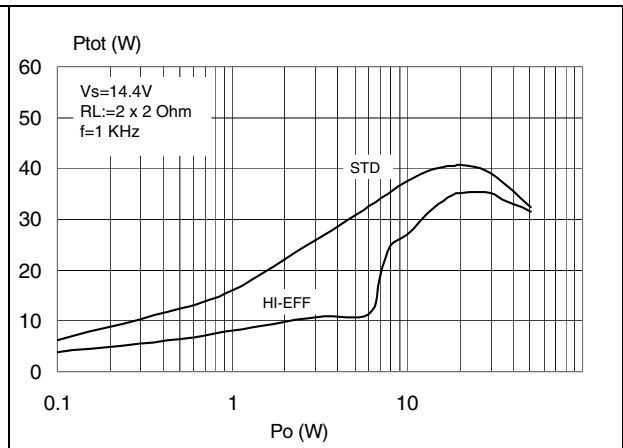

Figure 21. Power dissipation vs. average output power (Audio program simulation, 4Ω)

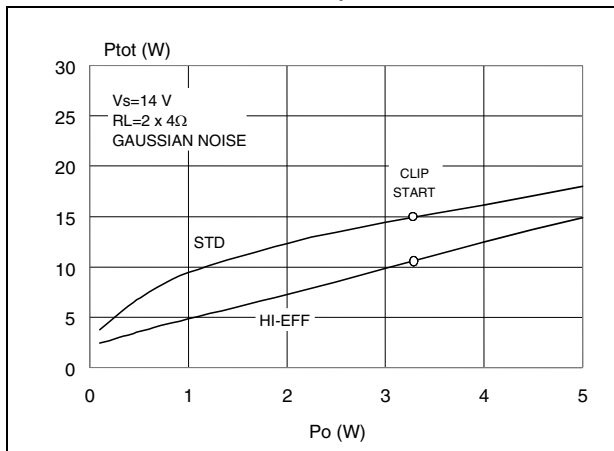

Figure 22. Power dissipation vs. average output power (Audio program simulation, 2Ω)

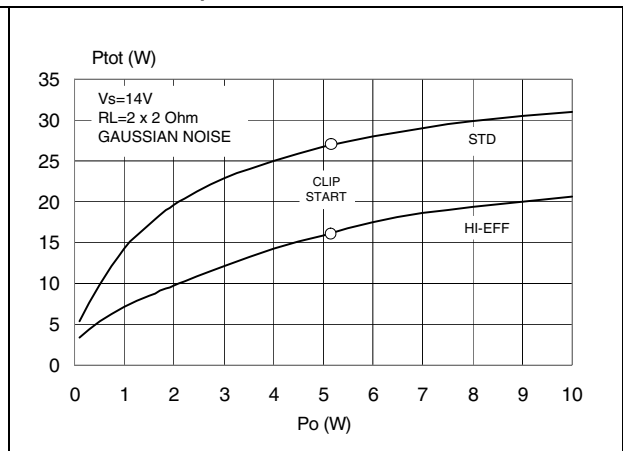
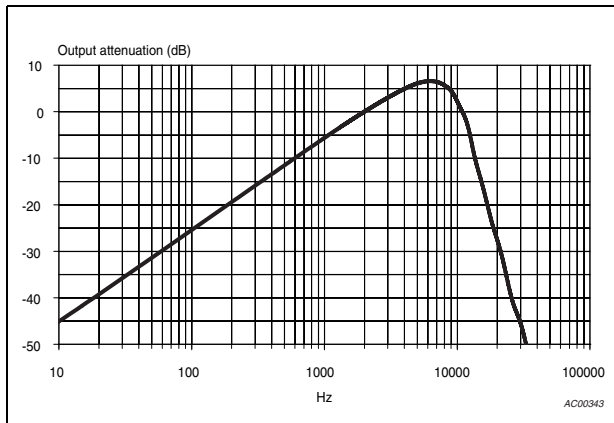

Figure 23. ITU R-ARM frequency response, weighting filter for transient pop



4 Application circuits

Figure 24. Application circuit (TDA7575B)

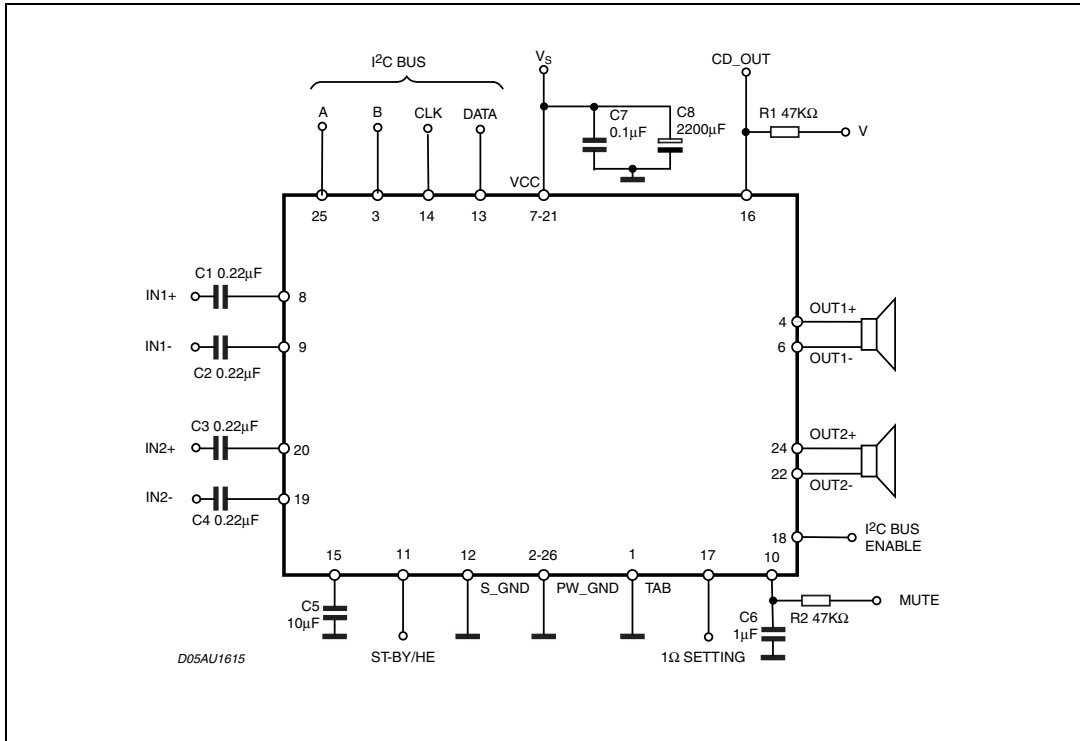
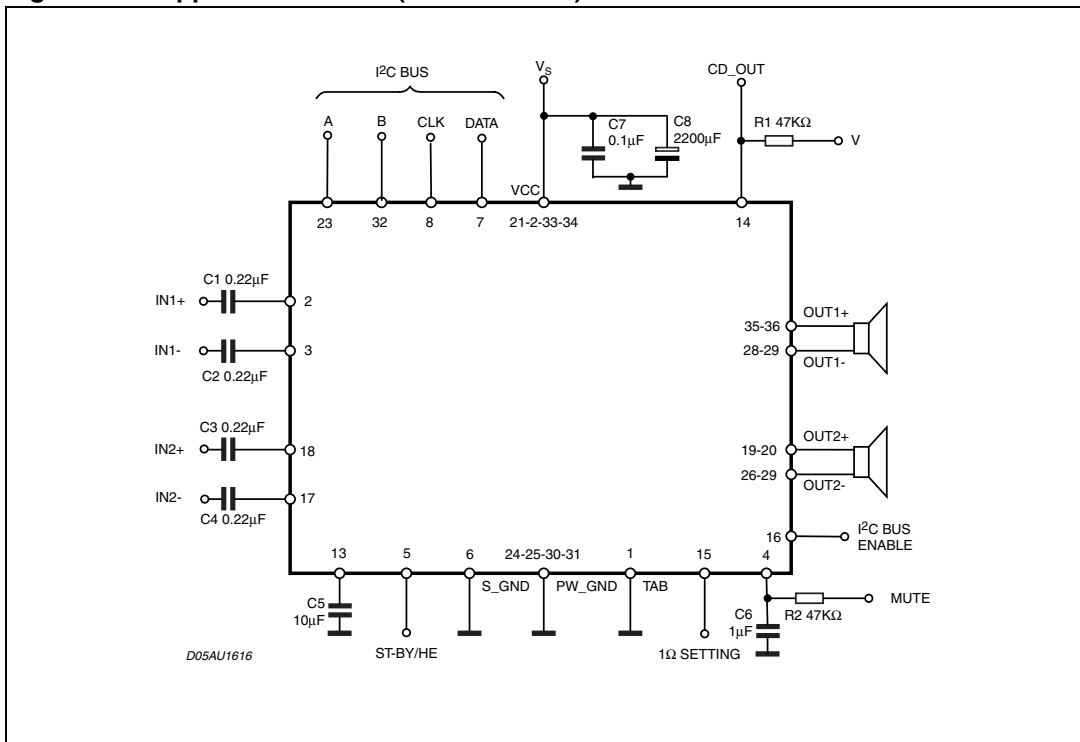

Figure 25. Application circuit (TDA7575BPD)



5 I²C bus interface

Data transmission from microprocessor to the TDA7575B and vice versa takes place through the 2 wires I²C BUS interface, consisting of the two lines SDA and SCL (pull-up resistors to positive supply voltage must be connected).

5.1 Data validity

As shown by [Figure 26](#), the data on the SDA line must be stable during the high period of the clock.

The high and low state of the data line can only change when the clock signal on the SCL line is low.

5.2 Start and stop conditions

As shown by [Figure 27](#) a start condition is a high to low transition of the SDA line while SCL is high.

The stop condition is a low to high transition of the SDA line while SCL is high.

5.3 Byte format

Every byte transferred to the SDA line must contain 8 bits. Each byte must be followed by an acknowledge bit. The MSB is transferred first.

5.4 Acknowledge

The transmitter^(*) puts a resistive HIGH level on the SDA line during the acknowledge clock pulse (see [Figure 28](#)). The receiver^(**) the acknowledges has to pull-down (LOW) the SDA line during the acknowledge clock pulse, so that the SDA line is stable LOW during this clock pulse.

(*) Transmitter

- = master (μ P) when it writes an address to the TDA7575B
- = slave (TDA7575B) when the μ P reads a data byte from TDA7575B

(**) Receiver

- = slave (TDA7575B) when the μ P writes an address to the TDA7575B
- = master (μ P) when it reads a data byte from TDA7575B

Figure 26. Data validity on the I²C bus

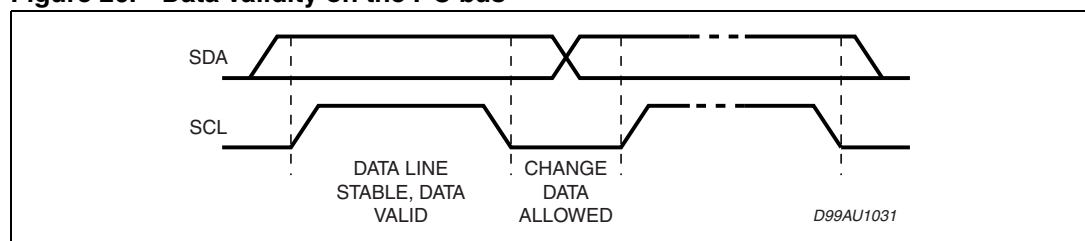
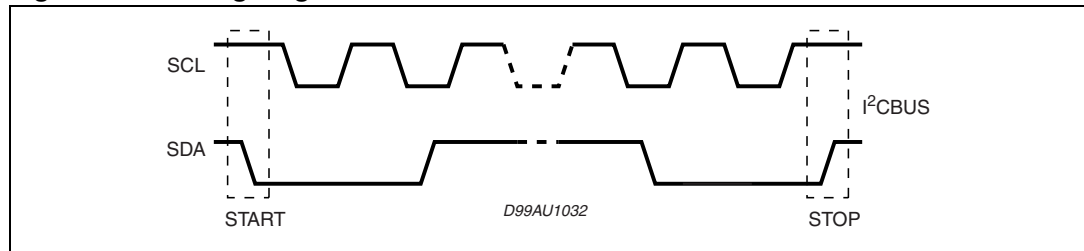
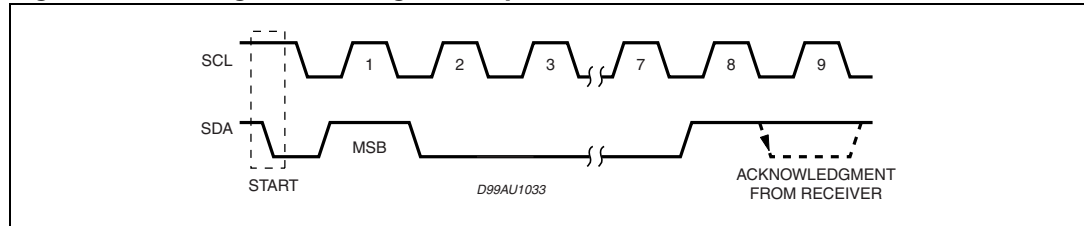

Figure 27. Timing diagram on the I²C bus**Figure 28. Timing acknowledge clock pulse**

5.5 1 Ω capability setting

It is possible to drive 1 Ω load paralleling the outputs into a single channel.

In order to implement this feature, outputs are to be connected on the board as follows:

- OUT1+ (pin 35 and pin 36) shorted to OUT2+ (pin 19 and pin 20)
- OUT1- (pin 28 and pin 29) shorted to OUT2- (pin 26 and pin 27).

It is recommended to minimize the impedance on the board between OUT2 and the load in order to minimize THD distortion. It is also recommended to control the maximum mismatch impedance between V_{CC} pins (pin 21/pin 22 respect to pin 33/pin 34) and between PWGND pins (pin 24/pin 25 respect to pin 30/pin 31), mismatch that must not exceed a value of 20 m Ω .

With 1 Ω feature settled the active input is IN2 (pin 17 and pin 18), therefore IN1 pins should be let floating.

It is possible to set the load capability acting on 1 Ω pin as follows:

- 1 Ω pin (pin 15) < 1.5 V: two channels mode (for a minimum load of 2 Ω)
- 1 Ω pin (pin 15) > 2.5 V: one channel mode (for 1 Ω load).

It is to remember that 1

Ohm function is a hardware selection.

Therefore it is recommended to leave 1 Ω pin floating or shorted to GND to set the two channels mode configuration, or to short 1 Ω pin to V_{CC} to set the one channel (1 Ω) configuration.

5.6 I²C abilitation setting

It is possible to disable the I²C interface by acting on I²C pin (pin 16) and control the TDA7575B by means of the usual standby and mute pins. In order to activate or deactivate this feature, I²C pin must be set as follows:

- I²C pin (pin 16) < 1.5V: I²C bus interface deactivated
- I²C pin (pin 16) > 2.5V: I²C bus interface activated

It is also possible to let I²C pin floating to deactivate the I²C bus interface, or to short I²C pin to V_{CC} to activate it.

In particular:

- I²C enabled: I²C pin (pin 16) > 2.5 V
 - STD mode: V_{st-by} (pin 5) > 3.5 V, IB2(D1)=0
 - HE mode: V_{st-by} (pin 5) > 3.5 V, IB2(D1)=1
 - Play mode: V_{mute} (pin 4) >3.5 V, IB1 (D2) = 1

The amplifier can always be switched off by putting V_{st-by} to 0V , but with I²C enabled it can be turn on only through I²C (with V_{st-by} > 3.5 V).

- I²C disabled: I²C pin (pin 16) < 1.5 V
 - STD mode: 3.5V < standby (pin 5) < 5
 - HE mode: V_{stby} (pin 5) > 7 V
 - Play mode: V_{mute} (pin 4) > 3.5 V

For both STD and HE mode the play/mute mode can be set acting on V_{mute} pin.

When I²C bus is disabled, when a fault is detected pin 14 (CD-OUT) is pulled down by the internal logic circuitry. The faults detected are the short circuit to ground, to V_{CC} and across the load (after an aver current detection).

6 Software specifications

All the functions of the TDA7575B are activated by I²C interface.

The bit 0 of the "Address Byte" defines if the next bytes are write instruction (from μ P to TDA7575B) or read instruction (from TDA7575B to μ P).

Table 5. Address selection

Bit	Address
A6	1
A5	1
A4	0
A3	1
A2	0
A1	B
A0	A
R/W	X

If R/W = 0, the μ P sends 2 "instruction bytes": IB1 and IB2.

Table 6. IB1

Bit	Instruction decoding bit
D7	0
D6	Diagnostic enable (D6 = 1) Diagnostic defeat (D6 = 0)
D5	Offset detection enable (D5 = 1) Offset detection defeat (D5 = 0)
D4	Gain = 26 dB (D4 = 0) Gain = 12 dB (D4 = 1)
D3	0
D2	Mute (D2 = 0) Unmute (D2 = 1)
D1	0
D0	CD 2% (D0 = 0) CD 10% (D0 = 1)

Table 7. IB2

Bit	Instruction decoding bit
D7	0
D6	0
D5	0
D4	Standby on - Amplifier not working - (D4 = 0) Standby off - Amplifier working - (D4 = 1)
D3	Power amplifier mode diagnostic (D3 = 0); Line driver mode diagnostic (D3 = 1)
D2	Current detection diagnostic enabled (D2 = 1) Current detection diagnostic defeat (D2 = 0)
D1	Power amplifier working in standard mode (D1 = 0) Power amplifier working in high efficiency mode (D1 = 1)
D0	Current detection threshold high (D7 = 0) Current detection threshold low (D7 = 1)

If R/W = 1, the TDA7575B sends 2 "Diagnostics Bytes" to μ P: DB1 and DB2.

Table 8. DB1

Bit	Instruction decoding bit		
D7	Thermal warning (if $T_{chip} \geq 150^{\circ}C$, D7 = 1)		
D6	Diag. cycle not activated or not terminated (D6 = 0) Diag. cycle terminated (D6 = 1)		
D5	<table border="0" style="width: 100%;"> <tr> <td style="width: 50%; vertical-align: top;"> Channel 1 current detection IB2 (D0) = 0 Output peak current < 250 mA - Open load (D5 = 1) Output peak current > 500 mA - Normal load (D5 = 0) </td> <td style="width: 50%; vertical-align: top;"> Channel LF current detection IB2 (D0) = 1 Output peak current < 125 mA - Open load (D5 = 1) Output peak current > 250 mA - Normal load (D5 = 0) </td> </tr> </table>	Channel 1 current detection IB2 (D0) = 0 Output peak current < 250 mA - Open load (D5 = 1) Output peak current > 500 mA - Normal load (D5 = 0)	Channel LF current detection IB2 (D0) = 1 Output peak current < 125 mA - Open load (D5 = 1) Output peak current > 250 mA - Normal load (D5 = 0)
Channel 1 current detection IB2 (D0) = 0 Output peak current < 250 mA - Open load (D5 = 1) Output peak current > 500 mA - Normal load (D5 = 0)	Channel LF current detection IB2 (D0) = 1 Output peak current < 125 mA - Open load (D5 = 1) Output peak current > 250 mA - Normal load (D5 = 0)		
D4	Channel 1 Turn-on diagnostic (D4 = 0) Permanent diagnostic (D4 = 1)		
D3	Channel 1 Normal load (D3 = 0) Short load (D3 = 1)		
D2	Channel 1 Turn-on diag.: No open load (D2 = 0) Open load detection (D2 = 1) Offset diag.: No output offset (D2 = 0) Output offset detection (D2 = 1)		
D1	Channel 1 No short to V_{cc} (D1 = 0) Short to V_{cc} (D1 = 1)		
D0	Channel 1 No short to GND (D1 = 0) Short to GND (D1 = 1)		

Table 9. DB2

Bit	Instruction decoding bit	
D7	Offset detection not activated (D7 = 0) Offset detection activated (D7 = 1)	
D6	Current sensor not activated (D6 = 0) Current sensor activated (D6 = 1)	
D5	Channel LR Current detection IB2 (D0) = 0 Output peak current < 250 mA - Open load (D5 = 1) Output peak current > 500 mA - Normal load (D5 = 0)	Channel LR Current detection IB2 (D0) = 1 Output peak current < TBD mA - Open load (D5 = 1) Output peak current > TBD mA - Normal load (D5 = 0)
D4	Channel 2 Turn-on diagnostic (D4 = 0) Permanent diagnostic (D4 = 1)	
D3	Channel 2 Normal load (D3 = 0) Short load (D3 = 1)	
D2	Channel 2 Turn-on diag.: No open load (D2 = 0) Open load detection (D2 = 1) Permanent diag.: No output offset (D2 = 0) Output offset detection (D2 = 1)	
D1	Channel 2 No short to V _{cc} (D1 = 0) Short to V _{cc} (D1 = 1)	
D0	Channel 2 No short to GND (D1 = 0) Short to GND (D1 = 1)	

6.1 Examples of bytes sequence

1 - Turn-on diagnostic - Write operation

Start	Address byte with D0 = 0	ACK	IB1 with D6 = 1	ACK	IB2	ACK	STOP
-------	--------------------------	-----	-----------------	-----	-----	-----	------

2 - Turn-on diagnostic - Read operation

Start	Address byte with D0 = 1	ACK	DB1	ACK	DB2	ACK	STOP
-------	--------------------------	-----	-----	-----	-----	-----	------

The delay from 1 to 2 can be selected by software, starting from T.B.D. ms

3a - Turn-on of the power amplifier with mute on, diagnostic defeat.

Start	Address byte with D0 = 0	ACK	IB1	ACK	IB2	ACK	STOP
			X000XXXX		XXX1XX1X		

3b - Turn-off of the power amplifier

Start	Address byte with D0 = 0	ACK	IB1	ACK	IB2	ACK	STOP
			X0XXXXXX		XXX0XXXX		

4 - Offset detection procedure enable

Start	Address byte with D0 = 0	ACK	IB1	ACK	IB2	ACK	STOP
			XX1XX1XX		XXX1XXXX		

5 - Offset detection procedure stop and reading operation (the results are valid only for the offset detection bits (D2 of the bytes DB1, DB2, DB3, DB4).

Start	Address byte with D0 = 1	ACK	DB1	ACK	DB2	ACK	STOP
-------	--------------------------	-----	-----	-----	-----	-----	------

- The purpose of this test is to check if a D.C. offset (2 V typ.) is present on the outputs, produced by input capacitor with anomalous leakage current or humidity between pins.
- The delay from 4 to 5 can be selected by software, starting from T.B.D. ms

7 Diagnostics functional description

7.1 Turn-on diagnostic

It is activated at the turn-on (stand-by out) under I²C bus request. Detectable output faults are:

- Short to GND
- Short TO Vs
- Short across the speaker
- Open speaker

To verify if any of the above misconnections are in place, a subsonic (inaudible) current pulse ([Figure 29](#)) is internally generated, sent through the speaker(s) and sunk back. The Turn On diagnostic status is internally stored until a successive diagnostic pulse is requested (after a I²C reading).

If the "stand-by out" and "diag. enable" commands are both given through a single programming step, the pulse takes place first (power stage still in stand-by mode, low, outputs = high impedance).

Afterwards, when the Amplifier is biased, the PERMANENT diagnostic takes place. The previous Turn On state is kept until a short appears at the outputs.

Figure 29. Turn-on diagnostic: working principle

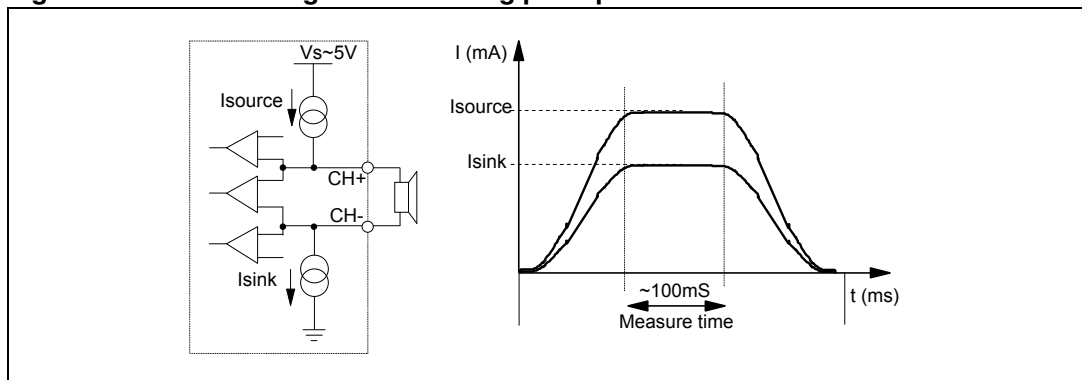

Fig. [Figure 30](#) and [Figure 31](#) show SVR and OUTPUT waveforms at the turn-on (stand-by out) with and without Turn-on diagnostic.

Figure 30. SVR and output behavior - case 1: without turn-on diagnostic

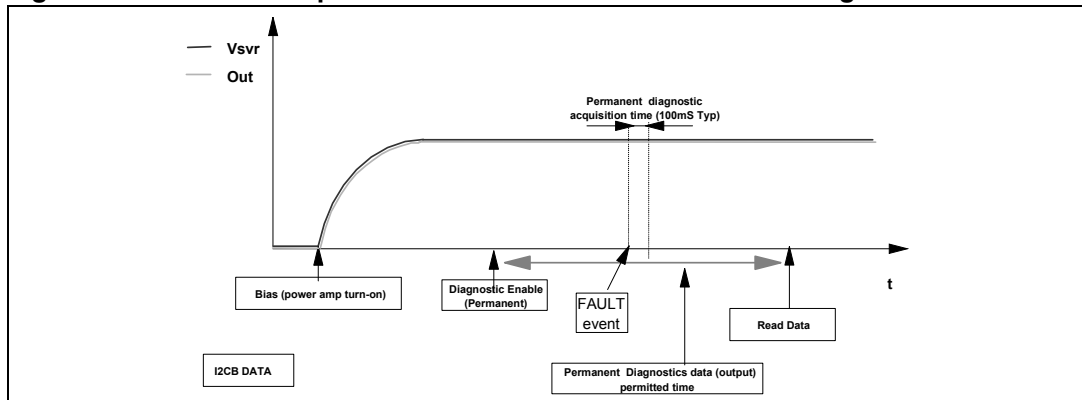
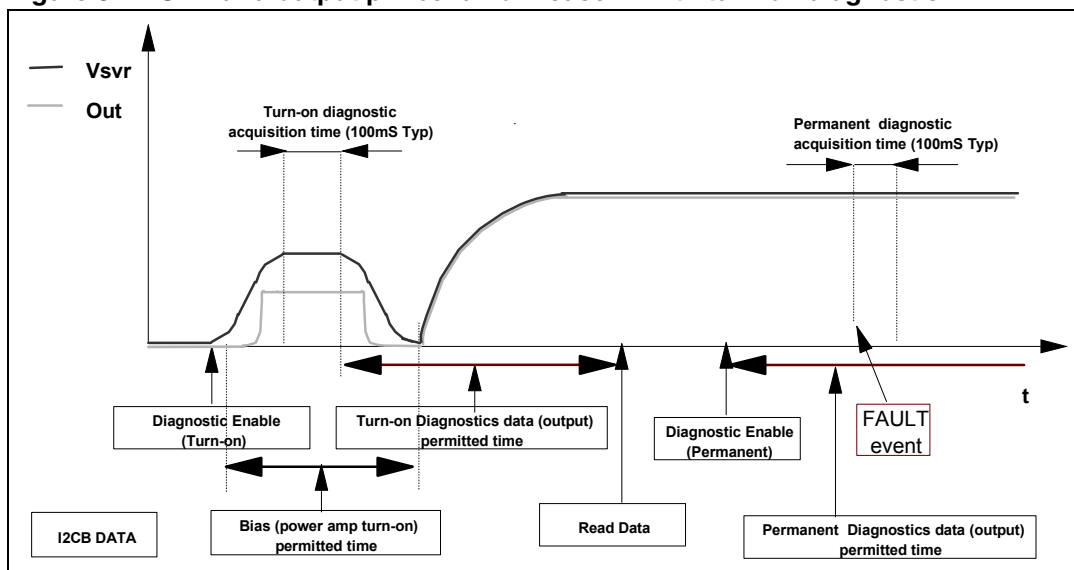
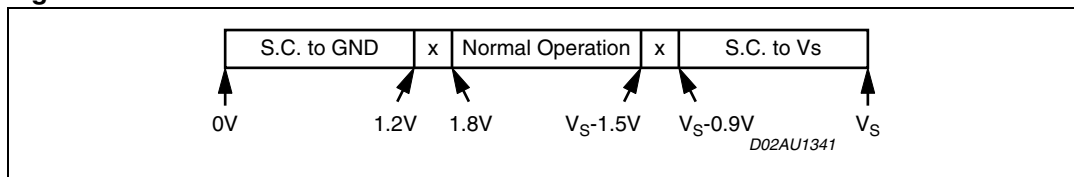

Figure 31. SVR and output pin behavior - case 2: with turn-on diagnostic



The information related to the outputs status is read and memorized at the end of the current pulse top. The acquisition time is 100 ms (typ.). No audible noise is generated in the process. As for short to GND / V_s the fault-detection thresholds remain unchanged from 26 dB to 12 dB gain setting. They are as follows:

Figure 32. Short circuit detection thresholds



Concerning short across the speaker / open speaker, the threshold varies from 26 dB to 12 dB gain setting, since different loads are expected (either normal speaker's impedance or high impedance). The values in case of 26 dB gain are as follows:

Figure 33. Load detection thresholds - high gain setting

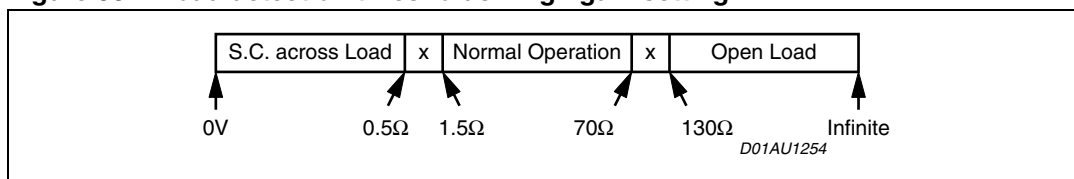

If the line-driver mode ($G_v = 12$ dB and line driver mode diagnostic = 1) is selected, the same thresholds will change as follows:

Figure 34. Load detection thresholds - high gain setting

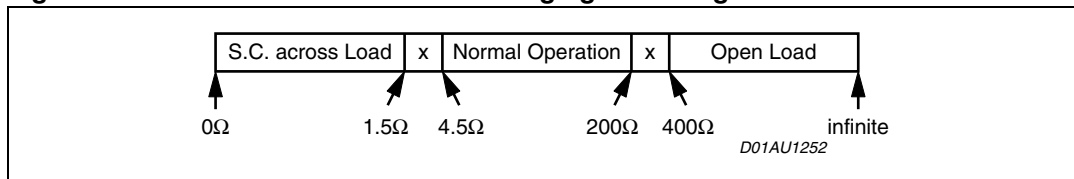

7.2 Permanent diagnostics

Detectable conventional faults are:

- Short to GND
- Short to V_s
- Short across the speaker

The following additional features are provided:

- Output offset detection

The TDA7575B has 2 operating statuses:

1. **RESTART mode.** The diagnostic is not enabled. Each audio channel operates independently from each other. If any of the a.m. faults occurs, only the channel(s) interested is shut down. A check of the output status is made every 1 ms (fig. 30). Restart takes place when the overload is removed.
2. **DIAGNOSTIC mode.** It is enabled via I²C bus and self activates if an output overload (such to cause the intervention of the short-circuit protection) occurs to the speakers outputs. Once activated, the diagnostics procedure develops as follows (fig. 31):
 - To avoid momentary re-circulation spikes from giving erroneous diagnostics, a check of the output status is made after 1ms: if normal situation (no overloads) is detected, the diagnostic is not performed and the channel returns back active.
 - Instead, if an overload is detected during the check after 1 ms, then a diagnostic cycle having a duration of about 100 ms is started.
 - After a diagnostic cycle, the audio channel interested by the fault is switched to RESTART mode. The relevant data are stored inside the device and can be read by the microprocessor. When one cycle has terminated, the next one is activated by an I²C reading. This is to ensure continuous diagnostics throughout the car-radio operating time.
 - To check the status of the device a sampling system is needed. The timing is chosen at microprocessor level (over than half a second is recommended).

Figure 35. Restart timing without diagnostic enable (permanent)
each 1ms time, a sampling of the fault is done

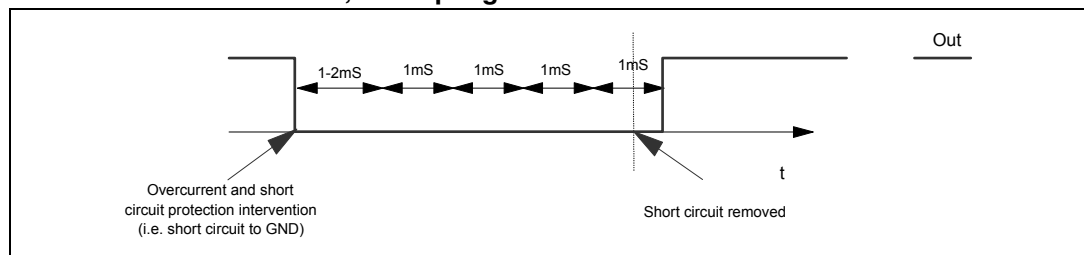
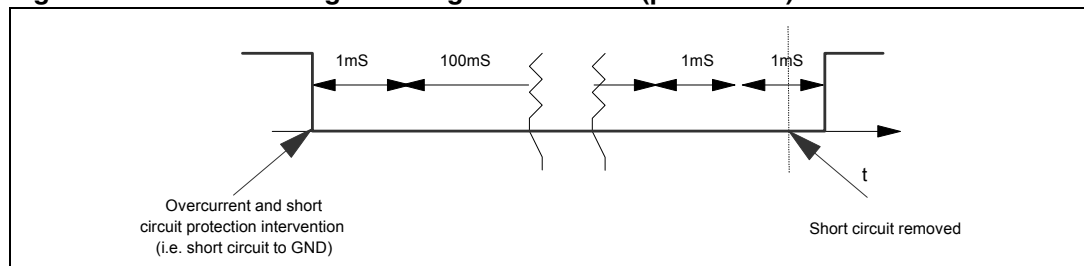

Figure 36. Restart timing with diagnostic enable (permanent)



7.3 Output DC offset detection

Any DC output offset exceeding ± 2 V are signalled out. This inconvenient might occur as a consequence of initially defective or aged and worn-out input capacitors feeding a DC component to the inputs, so putting the speakers at risk of overheating.

This diagnostic has to be performed with low-level output AC signal (or $V_{in} = 0$).

The test is run with selectable time duration by microprocessor (from a "start" to a "stop" command):

- Start = Last reading operation or setting IB1 - D5 - (OFFSET enable) to 1
- Stop = Actual reading operation

Excess offset is signalled out if persistent throughout the assigned testing time. This feature is disabled if any overloads leading to activation of the short-circuit protection occurs in the process.

7.4 AC diagnostic

It is targeted at detecting accidental disconnection of tweeters in 2-way speaker and, more in general, presence of capacitively (AC) coupled loads.

This diagnostic is based on the notion that the overall speaker's impedance (woofer + parallel tweeter) will tend to increase towards high frequencies if the tweeter gets disconnected, because the remaining speaker (woofer) would be out of its operating range (high impedance). The diagnostic decision is made according to peak output current thresholds, and it is enabled by setting (IB2-D2) = 1. Two different detection levels are available:

- High current threshold IB2 (D7) = 0
 - $I_{out} > 500$ mApk = normal status
 - $I_{out} < 250$ mApk = open tweeter
- Low current threshold IB2 (D7) = 1
 - $I_{out} > 250$ mApk = normal status
 - $I_{out} < 125$ mApk = open tweeter

To correctly implement this feature, it is necessary to briefly provide a signal tone (with the amplifier in "play") whose frequency and magnitude are such to determine an output current higher than 500mApk with IB2(D7)=0 (higher than 250mApk with IB2(D7)=1) in normal conditions and lower than 250 mApk with IB2(D7)=0 (lower than 125 mApk with IB2(D7)=1) should the parallel tweeter be missing.

The test has to last for a minimum number of 3 sine cycles starting from the activation of the AC diagnostic function IB2<D2>) up to the I²C reading of the results (measuring period). To confirm presence of tweeter, it is necessary to find at least 3 current pulses over the above thresholds over all the measuring period, else an "open tweeter" message will be issued.

The frequency / magnitude setting of the test tone depends on the impedance characteristics of each specific speaker being used, with or without the tweeter connected (to be calculated case by case). High-frequency tones (> 10 kHz) or even ultrasonic signals are recommended for their negligible acoustic impact and also to maximize the impedance module's ratio between with tweeter-on and tweeter-off.

Figure 37 shows the load impedance as a function of the peak output voltage and the relevant diagnostic fields. This feature is disabled if any overloads leading to activation of the short-circuit protection occurs in the process.

Figure 37. Current detection high: load impedance |Z| vs. output peak voltage

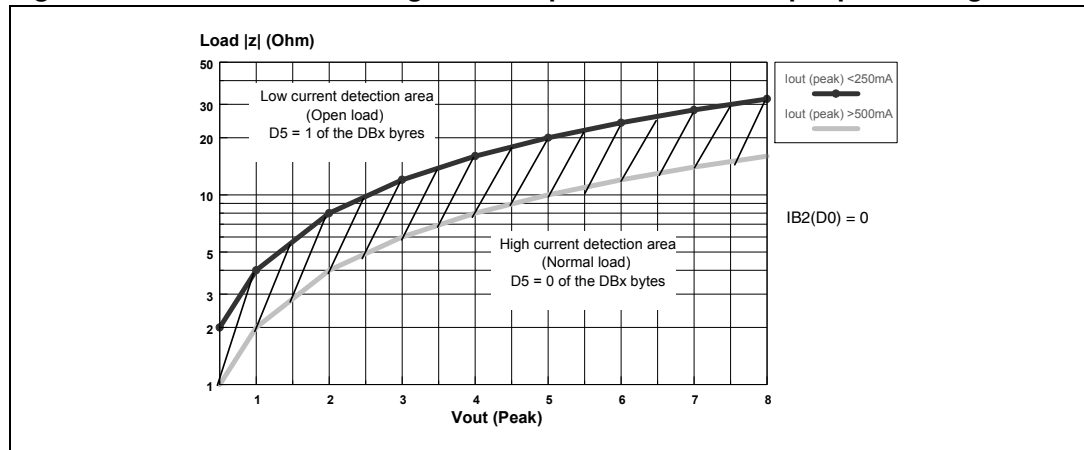
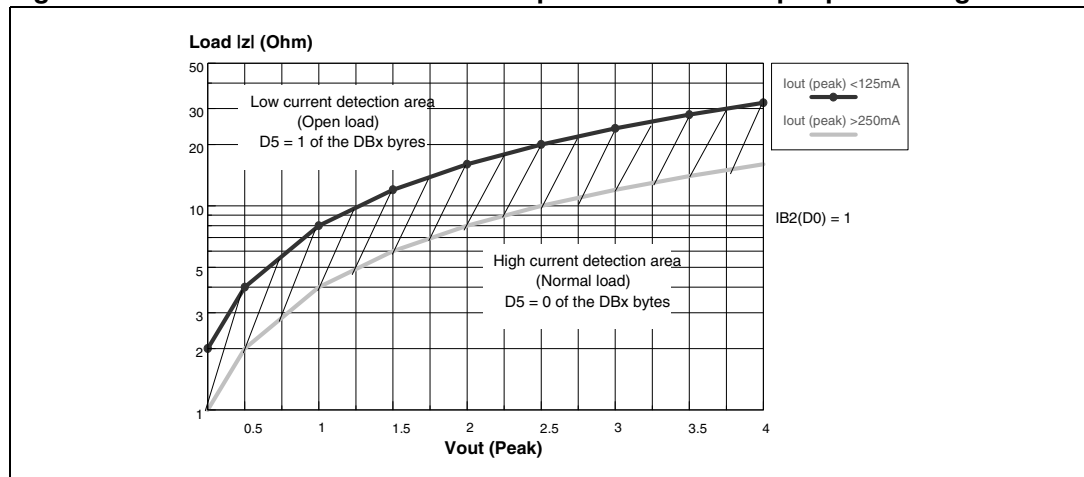

Figure 38. Current detection low: load impedance |Z| vs. output peak voltage



7.5 Multiple faults

When more misconnections are simultaneously in place at the audio outputs, it is guaranteed that at least one of them is initially read out. The others are notified after successive cycles of I²C reading and faults removal, provided that the diagnostic is enabled. This is true for both kinds of diagnostic (turn-on and permanent).

The table below shows all the couples of double-fault possible. It should be taken into account that a short circuit with the 4 Ω speaker unconnected is considered as double fault.

Table 10. Double fault table for turn-on diagnostic

	S. GND (sc)	S. GND (sk)	S. Vs	S. Across L.	Open L.
S. GND (sc)	S. GND	S. GND	S. Vs + S. GND	S. GND	S. GND
S. GND (sk)	/	S. GND	S. Vs	S. GND	Open L. (*)
S. Vs	/	/	S. Vs	S. Vs	S. Vs
S. Across L.	/	/	/	S. Across L.	N.A.
Open L.	/	/	/	/	Open L. (*)

S. GND (so) / S. GND (sk) in the above table make a distinction according to which of the 2 outputs is shorted to ground (test-current source side= so, test-current sink side = sk). More precisely, in both the channels SO = CH+, and SK = CH-.

In permanent diagnostic the table is the same, with only a difference concerning open load (*), which is not among the recognizable faults. Should an open load be present during the device's normal working, it would be detected at a subsequent turn-on diagnostic cycle (i.e. at the successive car radio turn-on).

7.6 Faults availability

All the results coming from I²C bus, by read operations, are the consequence of measurements inside a defined period of time. If the fault is stable throughout the whole period, it will be sent out. This is true for DC diagnostic (turn-on and permanent), for offset detector.

To guarantee always resident functions, every kind of diagnostic cycles (turn-on, permanent, offset) will be reactivate after any I²C reading operation. So, when the micro reads the I²C, a new cycle will be able to start, but the read data will come from the previous diag. cycle (i.e. The device is in turn-on state, with a short to GND, then the short is removed and micro reads I²C. The short to GND is still present in bytes, because it is the result of the previous cycle. If another I²C reading operation occurs, the bytes do not show the short). In general to observe a change in diagnostic bytes, two I²C reading operations are necessary.

7.7 I²C programming/reading sequences

A correct turn on/off sequence respectful of the diagnostic timings and producing no audible noises could be as follows (after battery connection):

- Turn-on: (Standby OUT + DIAG enable) --- 500 ms (min) --- muting OUT
- Turn-off: Muting IN --- 20 ms --- (DIAG disable + standby IN)

Car radio installation: DIAG enable (write) --- 20 0ms --- I²C read (repeat until all faults disappear).

- Offset test: device in play (no signal)
- Offset enable - 30 ms - I²C reading

(repeat I²C reading until high-offset message disappears).

8 Package information

In order to meet environmental requirements, ST offers these devices in different grades of ECOPACK® packages, depending on their level of environmental compliance. ECOPACK® specifications, grade definitions and product status are available at: www.st.com.

ECOPACK® is an ST trademark.

Figure 39. PowerSO36 (slug up) mechanical data and package dimensions

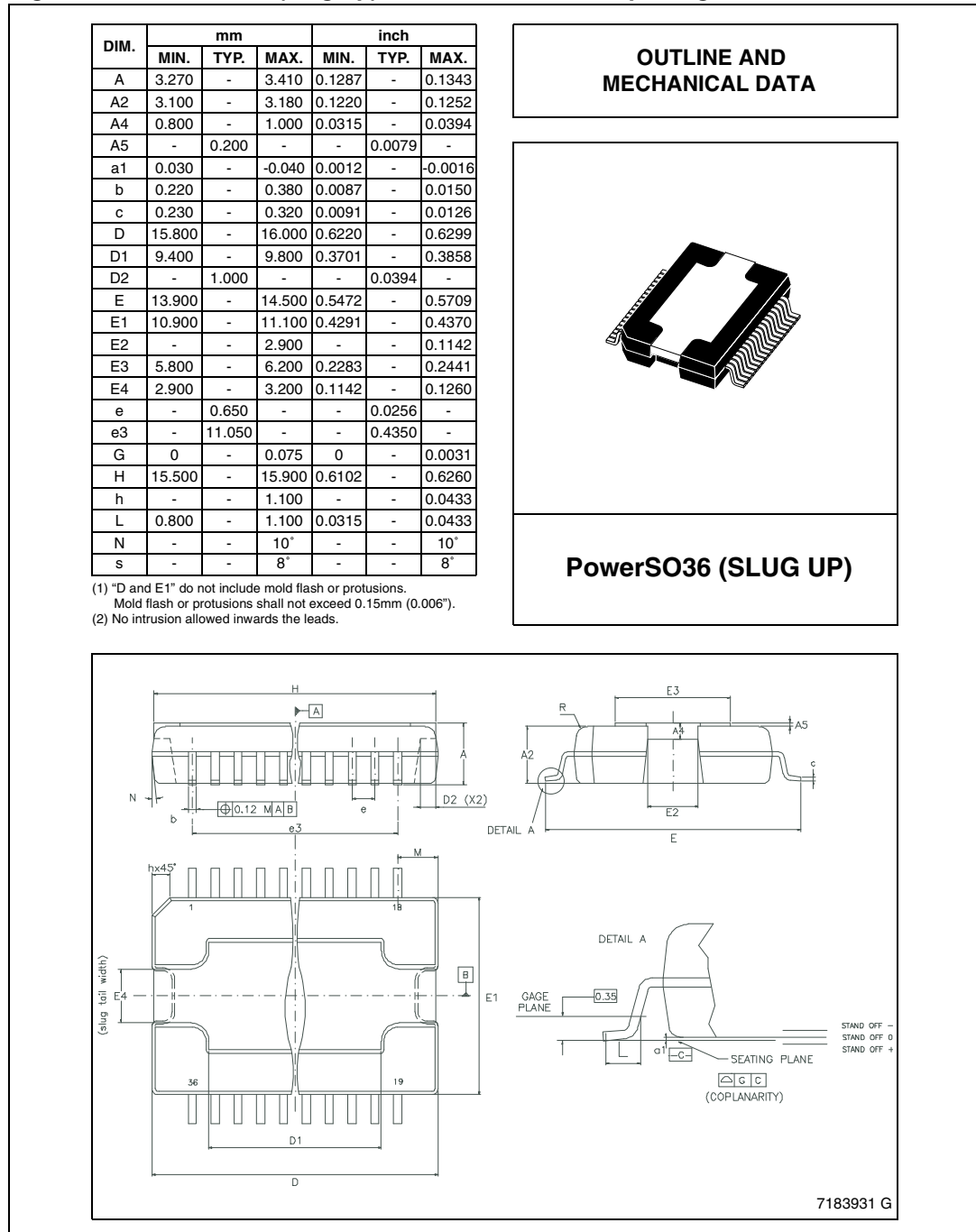
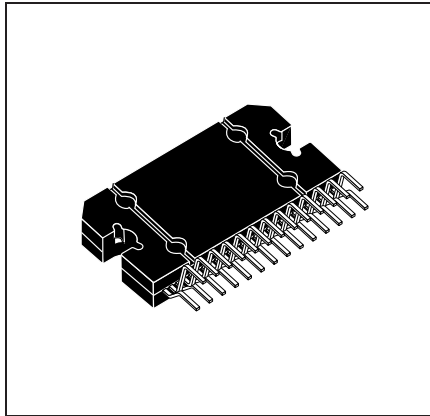

Figure 40. Flexiwatt27 (vertical) mechanical data and package dimensions

DIM.	mm			inch		
	MIN.	TYP.	MAX.	MIN.	TYP.	MAX.
A	4.45	4.50	4.65	0.175	0.177	0.183
B	1.80	1.90	2.00	0.070	0.074	0.079
C		1.40			0.055	
D	0.75	0.90	1.05	0.029	0.035	0.041
E	0.37	0.39	0.42	0.014	0.015	0.016
F (1)			0.57		0.022	
G	0.80	1.00	1.20	0.031	0.040	0.047
G1	25.75	26.00	26.25	1.014	1.023	1.033
H (2)	28.90	29.23	29.30	1.139	1.150	1.153
H1		17.00			0.669	
H2		12.80			0.503	
H3		0.80			0.031	
L (2)	22.07	22.47	22.87	0.869	0.884	0.904
L1	18.57	18.97	19.37	0.731	0.747	0.762
L2 (2)	15.50	15.70	15.90	0.610	0.618	0.626
L3	7.70	7.85	7.95	0.303	0.309	0.313
L4		5			0.197	
L5		3.5			0.138	
M	3.70	4.00	4.30	0.145	0.157	0.169
M1	3.60	4.00	4.40	0.142	0.157	0.173
N		2.20			0.086	
O		2			0.079	
R		1.70			0.067	
R1		0.5			0.02	
R2		0.3			0.12	
R3		1.25			0.049	
R4		0.50			0.019	
V			5° (Typ.)			
V1			3° (Typ.)			
V2			20° (Typ.)			
V3			45° (Typ.)			

OUTLINE AND MECHANICAL DATA



Flexiwatt27 (vertical)

(1): dam-bar protusion not included
 (2): molding protusion included

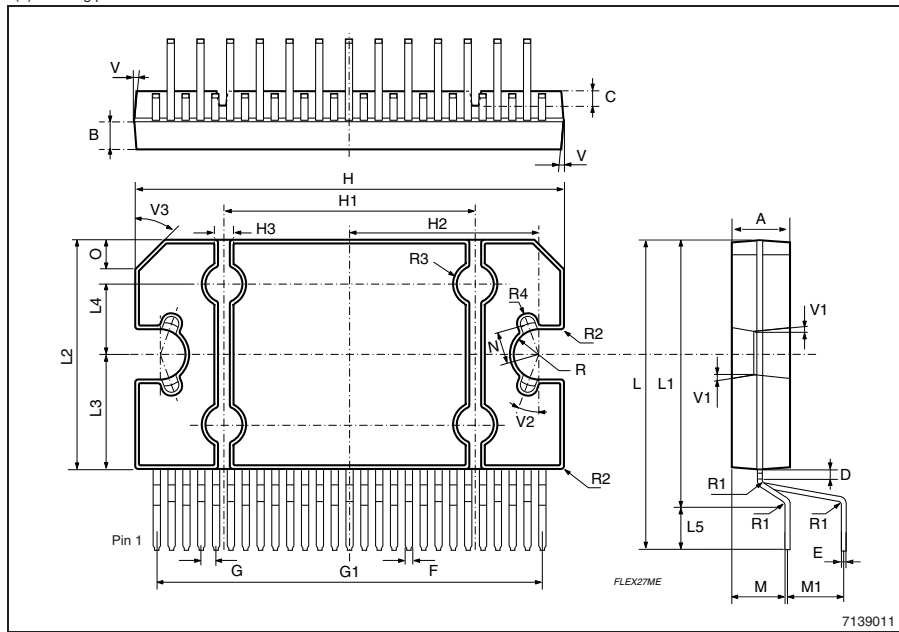

9 Revision history

Table 11. Document revision history

Date	Revision	Changes
30-Oct-2007	1	Initial release.
17-Dec-2009	2	Updated Figure 39: PowerSO36 (slug up) mechanical data and package dimensions on page 29.
17-Sep-2013	3	Updated Disclaimer.

Please Read Carefully:

Information in this document is provided solely in connection with ST products. STMicroelectronics NV and its subsidiaries ("ST") reserve the right to make changes, corrections, modifications or improvements, to this document, and the products and services described herein at any time, without notice.

All ST products are sold pursuant to ST's terms and conditions of sale.

Purchasers are solely responsible for the choice, selection and use of the ST products and services described herein, and ST assumes no liability whatsoever relating to the choice, selection or use of the ST products and services described herein.

No license, express or implied, by estoppel or otherwise, to any intellectual property rights is granted under this document. If any part of this document refers to any third party products or services it shall not be deemed a license grant by ST for the use of such third party products or services, or any intellectual property contained therein or considered as a warranty covering the use in any manner whatsoever of such third party products or services or any intellectual property contained therein.

UNLESS OTHERWISE SET FORTH IN ST'S TERMS AND CONDITIONS OF SALE ST DISCLAIMS ANY EXPRESS OR IMPLIED WARRANTY WITH RESPECT TO THE USE AND/OR SALE OF ST PRODUCTS INCLUDING WITHOUT LIMITATION IMPLIED WARRANTIES OF MERCHANTABILITY, FITNESS FOR A PARTICULAR PURPOSE (AND THEIR EQUIVALENTS UNDER THE LAWS OF ANY JURISDICTION), OR INFRINGEMENT OF ANY PATENT, COPYRIGHT OR OTHER INTELLECTUAL PROPERTY RIGHT.

ST PRODUCTS ARE NOT DESIGNED OR AUTHORIZED FOR USE IN: (A) SAFETY CRITICAL APPLICATIONS SUCH AS LIFE SUPPORTING, ACTIVE IMPLANTED DEVICES OR SYSTEMS WITH PRODUCT FUNCTIONAL SAFETY REQUIREMENTS; (B) AERONAUTIC APPLICATIONS; (C) AUTOMOTIVE APPLICATIONS OR ENVIRONMENTS, AND/OR (D) AEROSPACE APPLICATIONS OR ENVIRONMENTS. WHERE ST PRODUCTS ARE NOT DESIGNED FOR SUCH USE, THE PURCHASER SHALL USE PRODUCTS AT PURCHASER'S SOLE RISK, EVEN IF ST HAS BEEN INFORMED IN WRITING OF SUCH USAGE, UNLESS A PRODUCT IS EXPRESSLY DESIGNATED BY ST AS BEING INTENDED FOR "AUTOMOTIVE, AUTOMOTIVE SAFETY OR MEDICAL" INDUSTRY DOMAINS ACCORDING TO ST PRODUCT DESIGN SPECIFICATIONS. PRODUCTS FORMALLY ESCC, QML OR JAN QUALIFIED ARE DEEMED SUITABLE FOR USE IN AEROSPACE BY THE CORRESPONDING GOVERNMENTAL AGENCY.

Resale of ST products with provisions different from the statements and/or technical features set forth in this document shall immediately void any warranty granted by ST for the ST product or service described herein and shall not create or extend in any manner whatsoever, any liability of ST.

ST and the ST logo are trademarks or registered trademarks of ST in various countries.

Information in this document supersedes and replaces all information previously supplied.

The ST logo is a registered trademark of STMicroelectronics. All other names are the property of their respective owners.

© 2013 STMicroelectronics - All rights reserved

STMicroelectronics group of companies

Australia - Belgium - Brazil - Canada - China - Czech Republic - Finland - France - Germany - Hong Kong - India - Israel - Italy - Japan - Malaysia - Malta - Morocco - Philippines - Singapore - Spain - Sweden - Switzerland - United Kingdom - United States of America

www.st.com

Mouser Electronics

Authorized Distributor

Click to View Pricing, Inventory, Delivery & Lifecycle Information:

[STMicroelectronics:](#)

[TDA7575B](#) [TDA7575BPDTR](#) [TDA7575BPD](#)