

DC Fan

# 120×120×38 mm



San Ace 120 9G type

## General Specifications

- Material ..... Frame: Plastic (Flammability: UL 94V-0), Impeller: Plastic (Flammability: UL 94V-1)
- Expected life ..... See the table below. (L10 life: 90% survival rate for continuous operation in free air at 60°C, rated voltage)  
Expected life at 40°C is for reference only.
- Motor protection function ..... Locked rotor burnout protection, Reverse polarity protection  
For details, please refer to p. 573.
- Dielectric strength ..... 50/60 Hz, 500 VAC, for 1 minute (between lead wire conductors and frame)
- Insulation resistance ..... 10 MΩ or more with a 500 VDC megger (between lead wire conductors and frame)
- Sound pressure level (SPL) ..... At 1 m away from the air inlet
- Storage temperature ..... -30 to +70°C (Non-condensing)
- Lead wire ..... ⊕Red ⊖Black or Blue  Sensor  Yellow
- Mass ..... 330 g

## Specifications

The models listed below **have ribs and pulse sensors**. For models without ribs, append "1" to the end of model numbers.

Model no.	Rated voltage [V]	Operating voltage range [V]	Rated current [A]	Rated input [W]	Rated speed [min <sup>-1</sup> ]	Max. airflow [m <sup>3</sup> /min] [CFM]	Max. static pressure [Pa] [inchH <sub>2</sub> O]	SPL [dB (A)]	Operating temperature [°C]	Expected life [h]
9G1212G101	12	10.2 to 13.8	0.98	11.76	3600	3.88 137	135 0.542	49	-20 to +70	40000/60°C (70000/40°C)
9G1212E101			0.61	7.32	3100	3.34 118	100 0.402	46		
9G1212H101		7 to 13.8	0.38	4.56	2600	2.8 99	70.4 0.283	39		
9G1212F101			0.28	3.36	2280	2.45 87	54.2 0.218	36		
9G1212M101			0.21	2.52	1950	2.1 74	39.6 0.159	32		
9G1224G101			24	20.4 to 27.6	0.5	12	3600	3.88 137		
9G1224E101	0.34	8.16			3100	3.34 118	100 0.402	46		
9G1224H101	14 to 27.6	0.22		5.28	2600	2.8 99	70.4 0.283	39		
9G1224F101		0.16		3.84	2280	2.45 87	54.2 0.218	36		
9G1224M101		0.11		2.64	1950	2.1 74	39.6 0.159	32		
9G1248G101		48		40.8 to 55.2	0.25	12	3600	3.88 137		
9G1248E101	0.17		8.16		3100	3.34 118	100 0.402	46		
9G1248H101	0.11		5.28		2600	2.8 99	70.4 0.283	39		
9G1248F101	0.09		4.32		2280	2.45 87	54.2 0.218	36		
9G1248M101	0.07		3.36		1950	2.1 74	39.6 0.159	32		

The following sensor and control options are available for selection.

Available for all models.  Without sensor

Differs according to the model. Refer to the table on pp. 601 to 602.  Lock sensor  PWM control

The mark indicates Short LeadTime Service applicable models. See p. 626 for details.

## Airflow - Static Pressure Characteristics

**9G1212G101** With pulse sensor

Operating voltage range

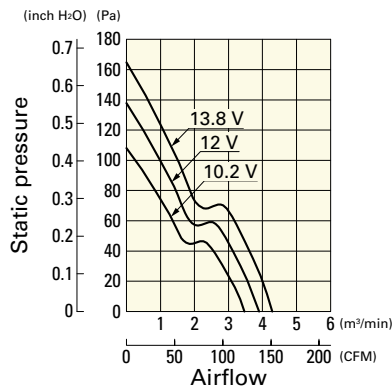

**9G1212E101** With pulse sensor

Operating voltage range

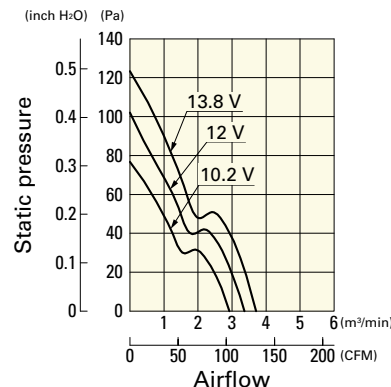

**9G1212H101** With pulse sensor

Operating voltage range

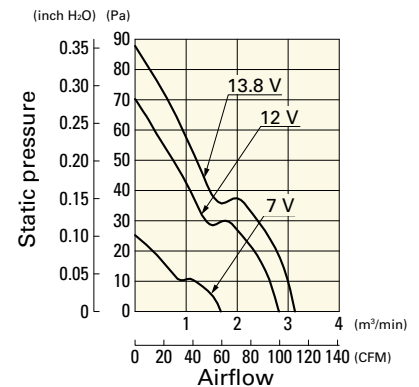

# Airflow - Static Pressure Characteristics

DC Fan 120 mm sq.

## 9G1212F101 With pulse sensor

Operating voltage range

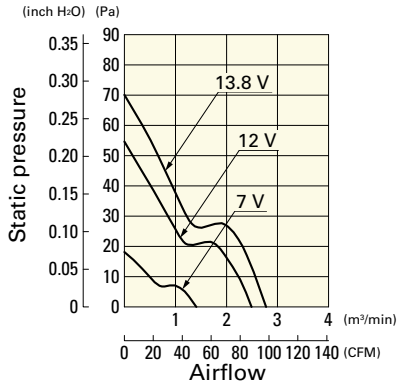

## 9G1212M101 With pulse sensor

Operating voltage range

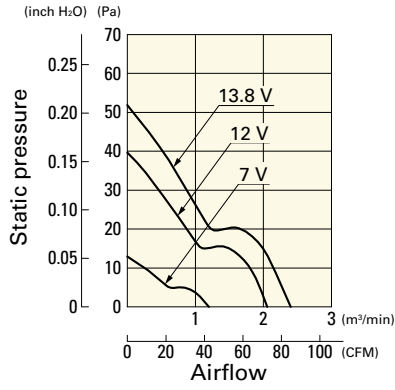

## 9G1224G101 With pulse sensor

Operating voltage range

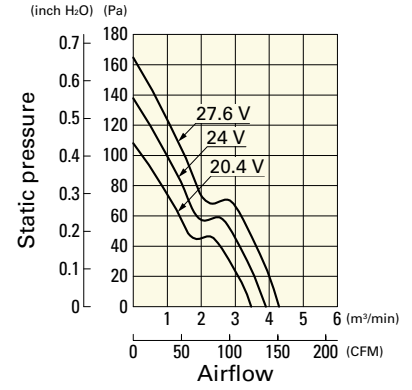

## 9G1224E101 With pulse sensor

Operating voltage range

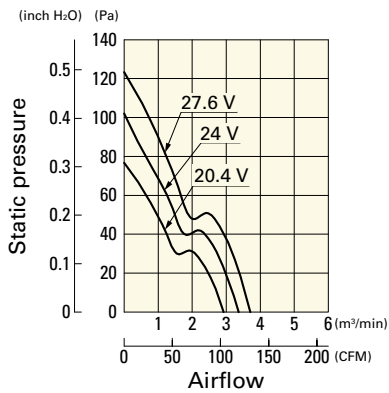

## 9G1224H101 With pulse sensor

Operating voltage range

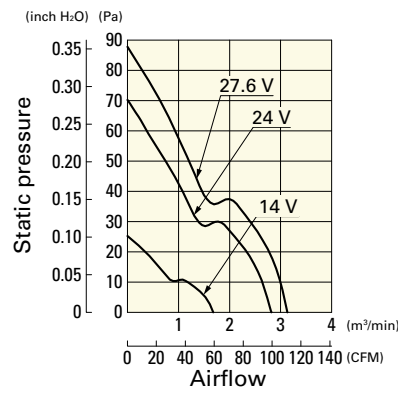

## 9G1224F101 With pulse sensor

Operating voltage range

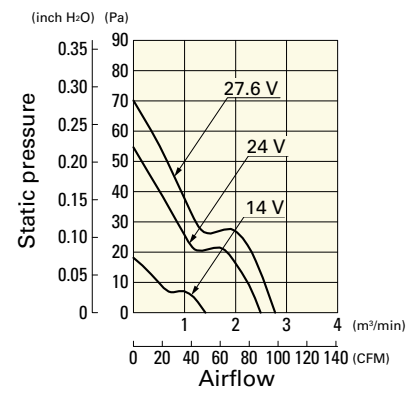

## 9G1224M101 With pulse sensor

Operating voltage range

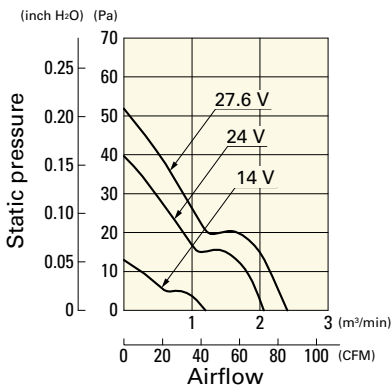

## 9G1248G101 With pulse sensor

Operating voltage range

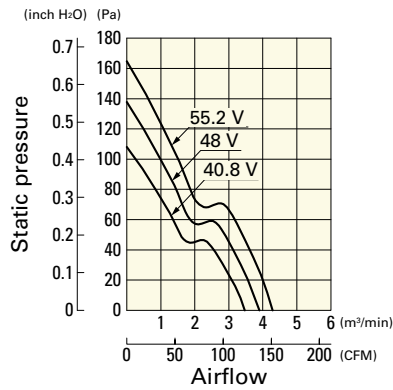

## 9G1248E101 With pulse sensor

Operating voltage range

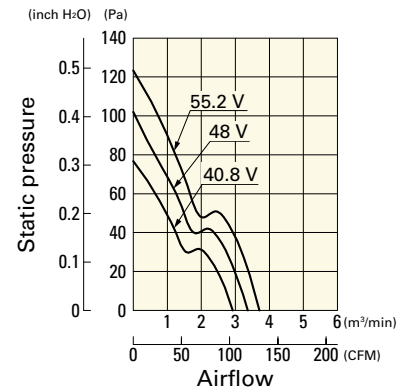

## 9G1248H101 With pulse sensor

Operating voltage range

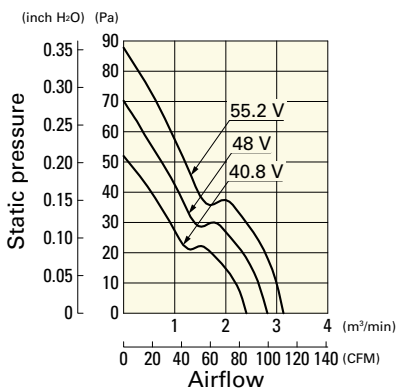

## 9G1248F101 With pulse sensor

Operating voltage range

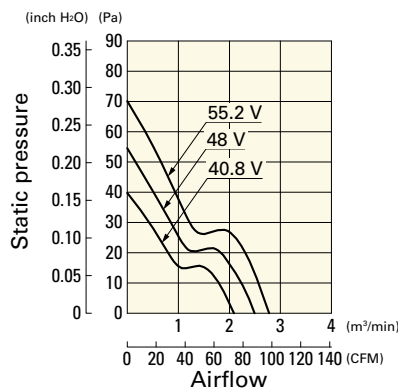

## 9G1248M101 With pulse sensor

Operating voltage range

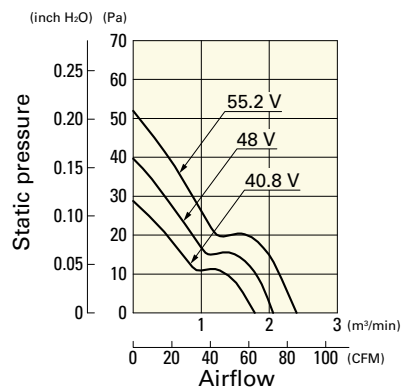

**Dimensions (unit: mm)** (With ribs)

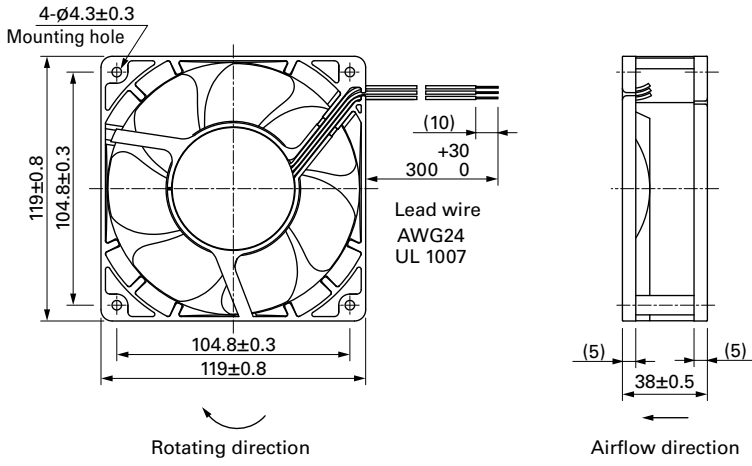

**Reference Dimensions of Mounting Holes and Vent Opening (unit: mm)**

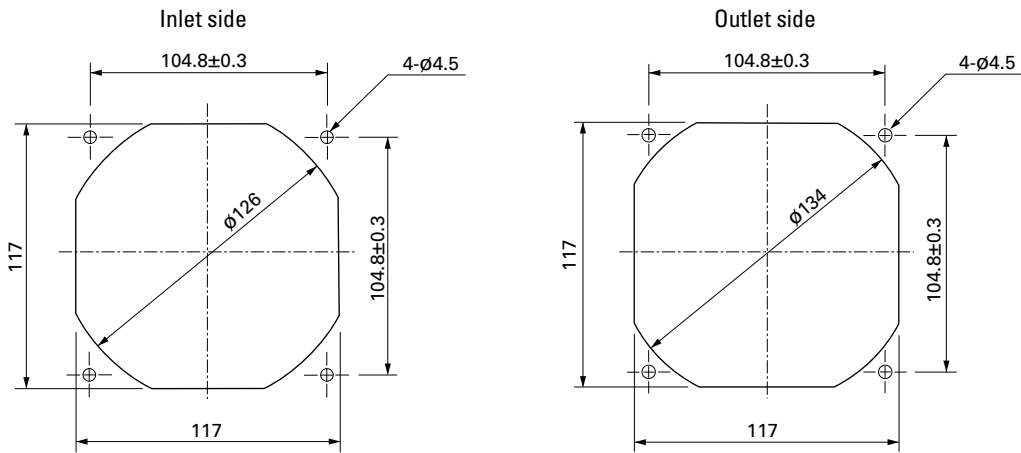

**Options**

**Finger guards**

page: p. 559

Model no.: 109-019E, 109-019K, 109-019C, 109-019H

**Resin finger guards**

page: p. 565

Model no.: 109-1000G

**Resin filter kits**

page: p. 566

Model no.: 109-1000F13 (13PPI), 109-1000F20 (20PPI),  
109-1000F30 (30PPI), 109-1000F40 (40PPI)