

SN74S1053

16-BIT SCHOTTKY BARRIER DIODE BUS-TERMINATION ARRAY

SDLS017A – SEPTEMBER 1990 – REVISED AUGUST 1997

- Designed to Reduce Reflection Noise
- Repetitive Peak Forward Current to 200 mA
- 16-Bit Array Structure Suited for Bus-Oriented Systems
- Package Options Include Plastic Small-Outline Packages and Standard Plastic 300-mil DIPs

DW OR N PACKAGE
(TOP VIEW)

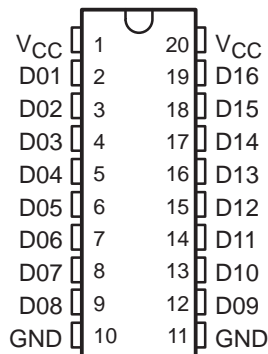

description

This Schottky barrier diode bus-termination array is designed to reduce reflection noise on memory bus lines. This device consists of a 16-bit high-speed Schottky diode array suitable for clamping to V_{CC} and/or GND.

The SN74S1053 is characterized for operation from 0°C to 70°C.

schematic diagrams

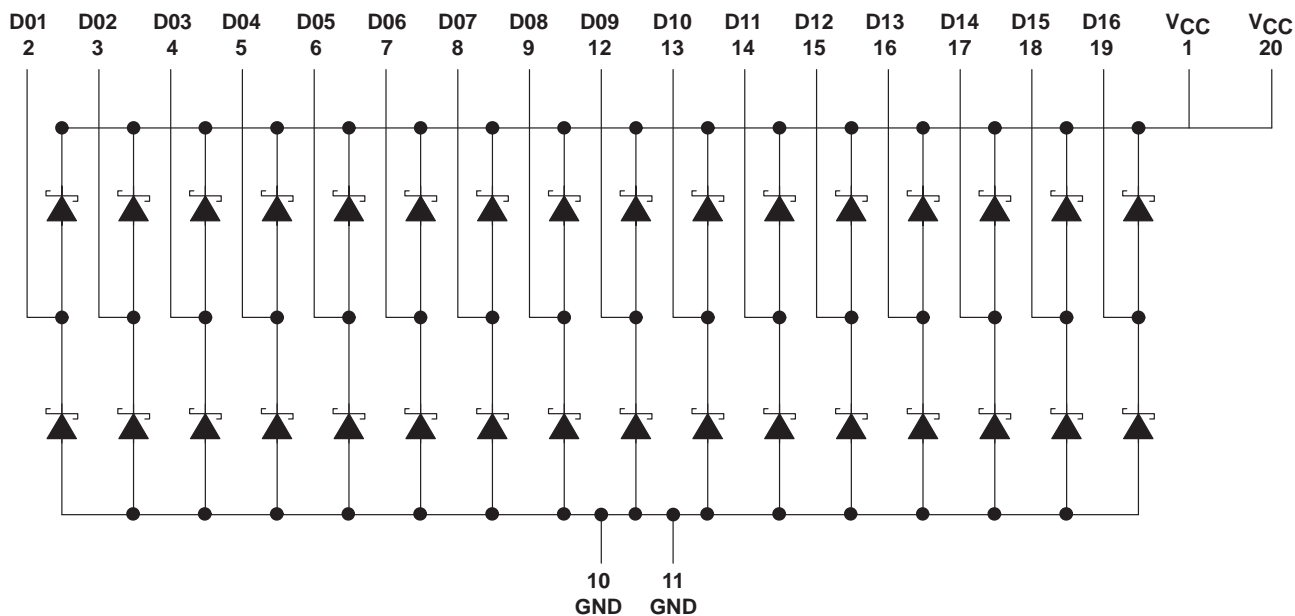

Please be aware that an important notice concerning availability, standard warranty, and use in critical applications of Texas Instruments semiconductor products and disclaimers thereto appears at the end of this data sheet.

PRODUCTION DATA information is current as of publication date. Products conform to specifications per the terms of Texas Instruments standard warranty. Production processing does not necessarily include testing of all parameters.

**TEXAS
INSTRUMENTS**

POST OFFICE BOX 655303 • DALLAS, TEXAS 75265

Copyright © 1997, Texas Instruments Incorporated

SN74S1053
16-BIT SCHOTTKY BARRIER DIODE
BUS-TERMINATION ARRAY

SDLS017A – SEPTEMBER 1990 – REVISED AUGUST 1997

absolute maximum ratings over operating free-air temperature range (unless otherwise noted)†

Steady-state reverse voltage, V_R	7 V
Continuous forward current, I_F : Any D terminal from GND or to V_{CC}	50 mA
Total through all GND or V_{CC} terminals	170 mA
Repetitive peak forward current‡, I_{FRM} : Any D terminal from GND or V_{CC}	200 mA
Total through all GND or V_{CC} terminals	1.2 A
Continuous total power dissipation at (or below) 25°C free-air temperature (see Note 1)	625 mW
Operating free-air temperature range	0°C to 70°C
Storage temperature range, T_{stg}	-65°C to 150°C

† Stresses beyond those listed under “absolute maximum ratings” may cause permanent damage to the device. These are stress ratings only, and functional operation of the device at these or any other conditions beyond those indicated under “recommended operating conditions” is not implied. Exposure to absolute-maximum-rated conditions for extended periods may affect device reliability.

‡ These values apply for $t_w \leq 100 \mu s$, duty cycle $\leq 20\%$.

NOTE 1: For operation above 25°C free-air temperature, derate linearly at the rate of 5 mW/°C.

electrical characteristics over recommended operating free-air temperature range (unless otherwise noted)

single-diode operation (see Note 2)

PARAMETER		TEST CONDITIONS		MIN	TYP§	MAX	UNIT
V_F	Static forward voltage	To V_{CC}	$I_F = 18 \text{ mA}$	0.85	1.05	V	
			$I_F = 50 \text{ mA}$	1.05	1.3		
		From GND	$I_F = 18 \text{ mA}$	0.75	0.95		
			$I_F = 50 \text{ mA}$	0.95	1.2		
V_{FM}	Peak forward voltage		$I_F = 200 \text{ mA}$	1.45		V	
I_R	Static reverse current	To V_{CC}	$V_R = 7 \text{ V}$			5	μA
		From GND			5		
C_t	Total capacitance	$V_R = 0 \text{ V}, f = 1 \text{ MHz}$		8	16	pF	
		$V_R = 2 \text{ V}, f = 1 \text{ MHz}$		4	8		

§ All typical values are at $V_{CC} = 5 \text{ V}, T_A = 25^\circ C$.

NOTE 2: Test conditions and limits apply separately to each of the diodes. The diodes not under test are open-circuited during the measurement of these characteristics.

multiple-diode operation

PARAMETER		TEST CONDITIONS		MIN	TYP‡	MAX	UNIT
I_x	Internal crosstalk current	Total I_F current = 1 A,	See Note 3	0.8	2	mA	
		Total I_F current = 198 mA,	See Note 3	0.02	0.2		

§ All typical values are at $V_{CC} = 5 \text{ V}, T_A = 25^\circ C$.

NOTE 3: I_x is measured under the following conditions with one diode static, and all others switching:

Switching diodes: $t_w = 100 \mu s$, duty cycle = 20%

Static diode: $V_R = 5 \text{ V}$

The static diode input current is the internal crosstalk current I_x .

switching characteristics, $T_A = 25^\circ C$ (see Figures 1 and 2)

PARAMETER		TEST CONDITIONS				MIN	TYP	MAX	UNIT
t_{rr}	Reverse recovery time	$I_F = 10 \text{ mA}, I_{RM(REC)} = 10 \text{ mA}, I_{R(REC)} = 1 \text{ mA}, R_L = 100 \Omega$				8	16	ns	



PARAMETER MEASUREMENT INFORMATION

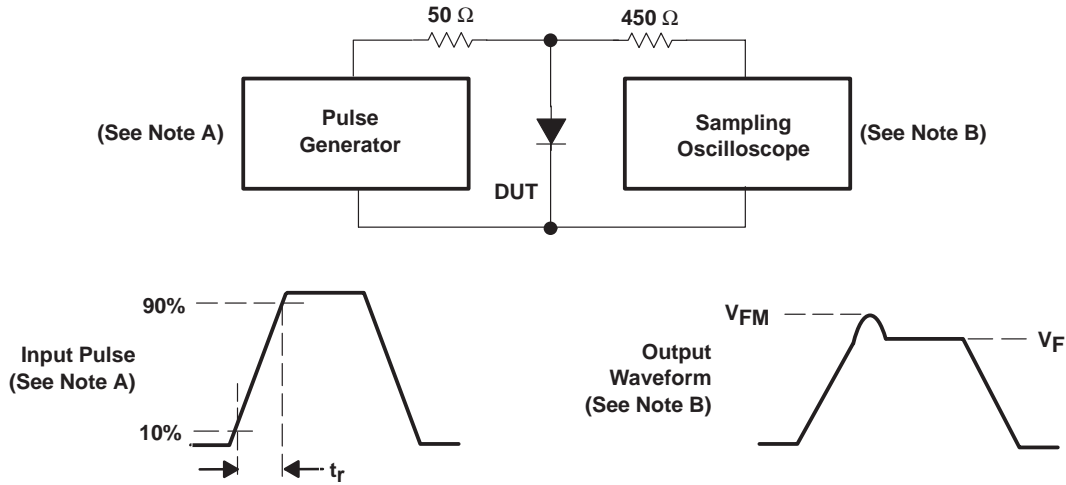

- NOTES: A. The input pulse is supplied by a pulse generator having the following characteristics: $t_r = 20$ ns, $Z_O = 50 \Omega$, freq = 500 Hz, duty cycle = 1%.
 B. The output waveform is monitored by an oscilloscope having the following characteristics: $t_r \leq 350$ ps, $R_i = 50 \Omega$, $C_i \leq 5$ pF.

Figure 1. Forward Recovery Voltage

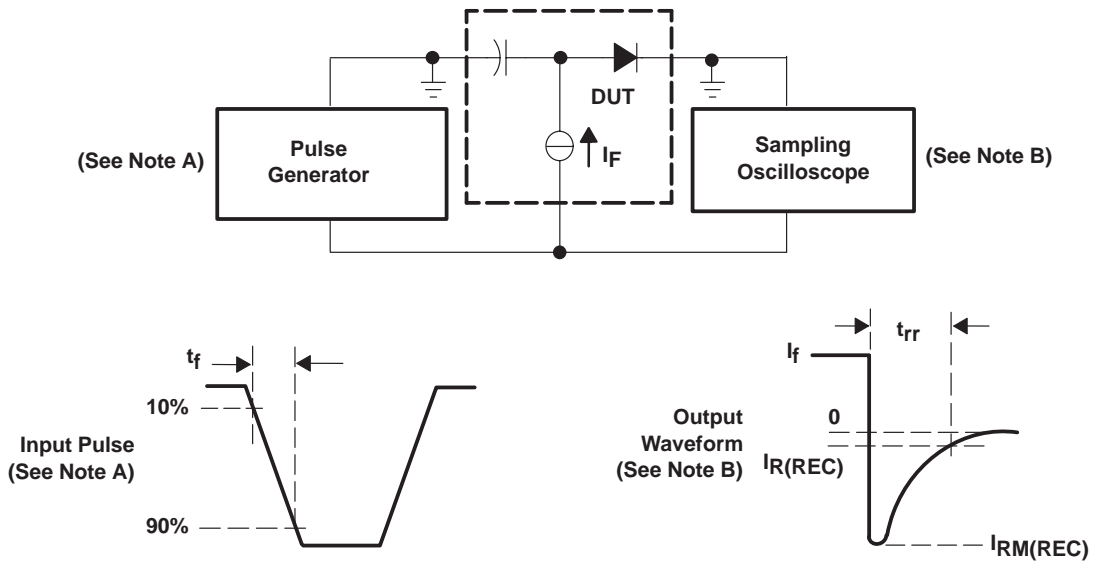

- NOTES: A. The input pulse is supplied by a pulse generator having the following characteristics: $t_f = 0.5$ ns, $Z_O = 50 \Omega$, $t_w \geq 50$ ns, duty cycle = 1%.
 B. The output waveform is monitored by an oscilloscope having the following characteristics: $t_r \leq 350$ ps, $R_i = 50 \Omega$, $C_i \leq 5$ pF.

Figure 2. Reverse Recovery Time

SN74S1053

16-BIT SCHOTTKY BARRIER DIODE

BUS-TERMINATION ARRAY

SDLS017A – SEPTEMBER 1990 – REVISED AUGUST 1997

APPLICATION INFORMATION

Large negative transients occurring at the inputs of memory devices (DRAMs, SRAMs, EPROMs, etc.) or on the CLOCK lines of many clocked devices can result in improper operation of the devices. The SN74S1053 diode termination array helps suppress negative transients caused by transmission-line reflections, crosstalk, and switching noise.

Diode terminations have several advantages when compared to resistor termination schemes. Split resistor or Thevenin equivalent termination can cause a substantial increase in power consumption. The use of a single resistor to ground to terminate a line usually results in degradation of the output high level, resulting in reduced noise immunity. Series damping resistors placed on the outputs of the driver reduce negative transients, but they also can increase propagation delays down the line, as a series resistor reduces the output drive capability of the driving device. Diode terminations have none of these drawbacks.

The operation of the diode arrays in reducing negative transients is explained in the following figures. The diode conducts current when the voltage reaches a negative value large enough for the diode to turn on. Suppression of negative transients is tracked by the current-voltage characteristic curve for that diode. Typical current versus voltage curves for the SN74S1053 are shown in Figures 3 and 4.

To illustrate how the diode arrays act to reduce negative transients at the end of a transmission line, the test setup in Figure 5 was evaluated. The resulting waveforms with and without the diode are shown in Figure 6.

The maximum effectiveness of the diode arrays in suppressing negative transients occurs when the diode arrays are placed at the end of a line and/or the end of a long stub branching off a main transmission line. The diodes also can be used to reduce the negative transients that occur due to discontinuities in the middle of a line. An example of this is a slot in a backplane that is provided for an add-on card.

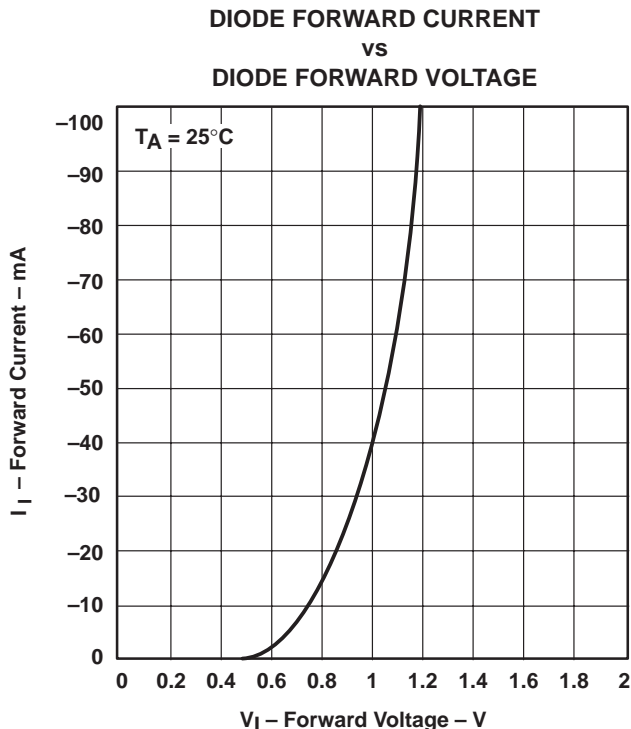
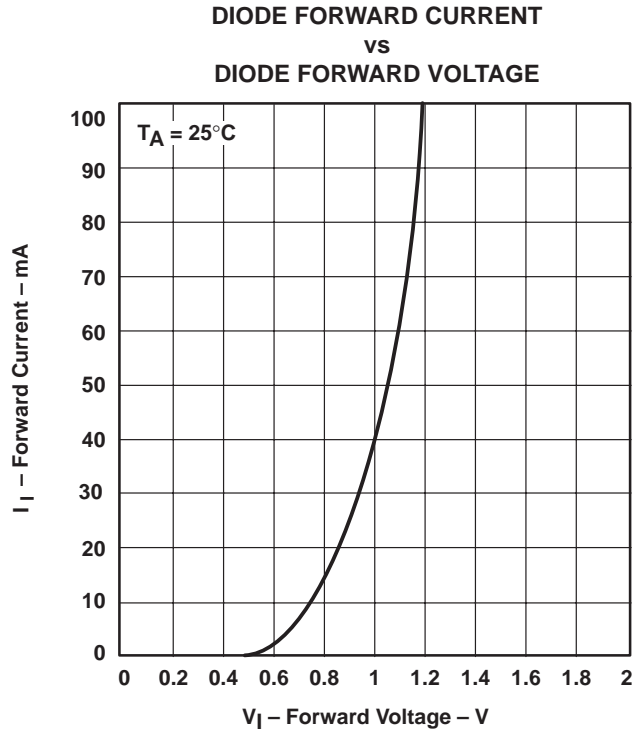

Figure 3. Typical Input Current vs Input Voltage (Lower Diode)



**Figure 4. Typical Input Current vs Input Voltage
(Upper Diode)**

SN74S1053
16-BIT SCHOTTKY BARRIER DIODE
BUS-TERMINATION ARRAY

SDLS017A – SEPTEMBER 1990 – REVISED AUGUST 1997

APPLICATION INFORMATION

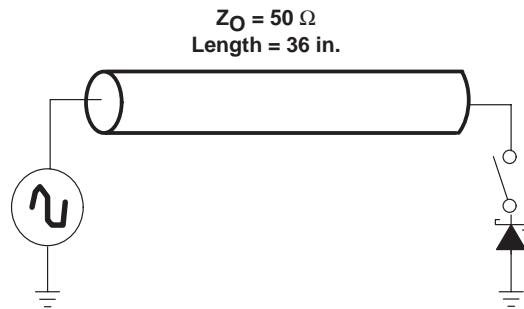

Figure 5. Diode Test Setup

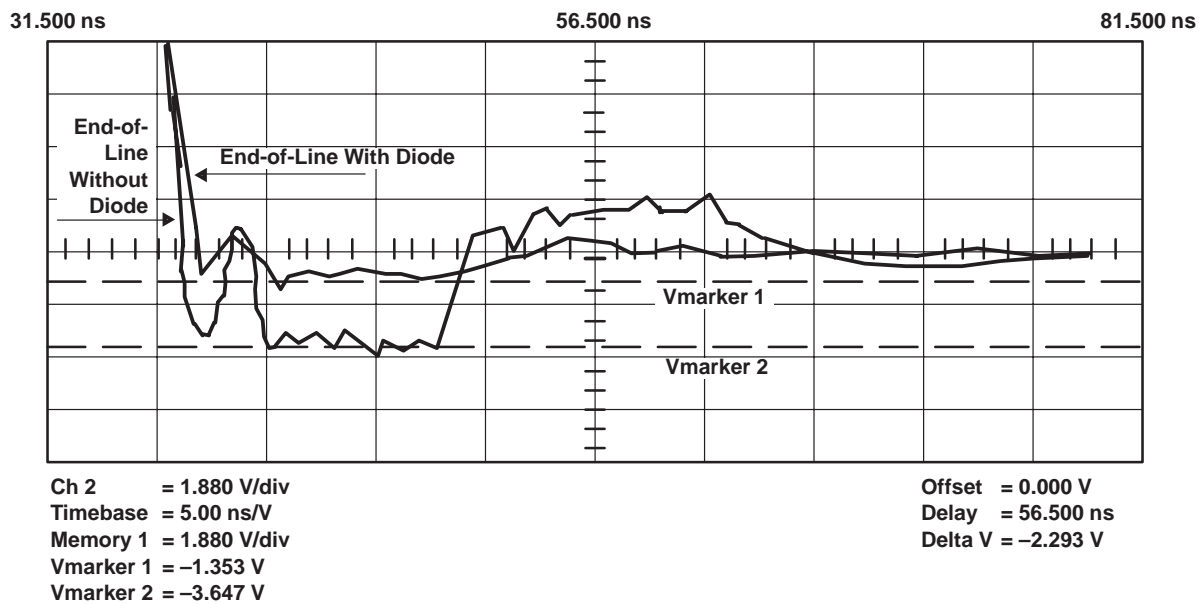

Figure 6. Oscilloscope Display

PACKAGING INFORMATION

Orderable Device	Status (1)	Package Type	Package Drawing	Pins	Package Qty	Eco Plan (2)	Lead/Ball Finish (6)	MSL Peak Temp (3)	Op Temp (°C)	Device Marking (4/5)	Samples
SN74S1053DBR	ACTIVE	SSOP	DB	20	2000	Green (RoHS & no Sb/Br)	NIPDAU	Level-1-260C-UNLIM	0 to 70	S1053	Samples
SN74S1053DW	ACTIVE	SOIC	DW	20	25	Green (RoHS & no Sb/Br)	NIPDAU	Level-1-260C-UNLIM	0 to 70	S1053	Samples
SN74S1053DWR	ACTIVE	SOIC	DW	20	2000	Green (RoHS & no Sb/Br)	NIPDAU	Level-1-260C-UNLIM	0 to 70	S1053	Samples
SN74S1053N	ACTIVE	PDIP	N	20	20	Pb-Free (RoHS)	NIPDAU	N / A for Pkg Type	0 to 70	SN74S1053N	Samples
SN74S1053NE4	ACTIVE	PDIP	N	20	20	Pb-Free (RoHS)	NIPDAU	N / A for Pkg Type	0 to 70	SN74S1053N	Samples
SN74S1053NSR	ACTIVE	SO	NS	20	2000	Green (RoHS & no Sb/Br)	NIPDAU	Level-1-260C-UNLIM	0 to 70	74S1053	Samples
SN74S1053PW	ACTIVE	TSSOP	PW	20	70	Green (RoHS & no Sb/Br)	NIPDAU	Level-1-260C-UNLIM	0 to 70	S1053	Samples
SN74S1053PWR	ACTIVE	TSSOP	PW	20	2000	Green (RoHS & no Sb/Br)	NIPDAU	Level-1-260C-UNLIM	0 to 70	S1053	Samples

(1) The marketing status values are defined as follows:

ACTIVE: Product device recommended for new designs.

LIFEBUY: TI has announced that the device will be discontinued, and a lifetime-buy period is in effect.

NRND: Not recommended for new designs. Device is in production to support existing customers, but TI does not recommend using this part in a new design.

PREVIEW: Device has been announced but is not in production. Samples may or may not be available.

OBSELETE: TI has discontinued the production of the device.

(2) **RoHS:** TI defines "RoHS" to mean semiconductor products that are compliant with the current EU RoHS requirements for all 10 RoHS substances, including the requirement that RoHS substance do not exceed 0.1% by weight in homogeneous materials. Where designed to be soldered at high temperatures, "RoHS" products are suitable for use in specified lead-free processes. TI may reference these types of products as "Pb-Free".

RoHS Exempt: TI defines "RoHS Exempt" to mean products that contain lead but are compliant with EU RoHS pursuant to a specific EU RoHS exemption.

Green: TI defines "Green" to mean the content of Chlorine (Cl) and Bromine (Br) based flame retardants meet JS709B low halogen requirements of <=100ppm threshold. Antimony trioxide based flame retardants must also meet the <=1000ppm threshold requirement.

(3) MSL, Peak Temp. - The Moisture Sensitivity Level rating according to the JEDEC industry standard classifications, and peak solder temperature.

(4) There may be additional marking, which relates to the logo, the lot trace code information, or the environmental category on the device.

⁽⁵⁾ Multiple Device Markings will be inside parentheses. Only one Device Marking contained in parentheses and separated by a "-" will appear on a device. If a line is indented then it is a continuation of the previous line and the two combined represent the entire Device Marking for that device.

⁽⁶⁾ Lead/Ball Finish - Orderable Devices may have multiple material finish options. Finish options are separated by a vertical ruled line. Lead/Ball Finish values may wrap to two lines if the finish value exceeds the maximum column width.

Important Information and Disclaimer:The information provided on this page represents TI's knowledge and belief as of the date that it is provided. TI bases its knowledge and belief on information provided by third parties, and makes no representation or warranty as to the accuracy of such information. Efforts are underway to better integrate information from third parties. TI has taken and continues to take reasonable steps to provide representative and accurate information but may not have conducted destructive testing or chemical analysis on incoming materials and chemicals. TI and TI suppliers consider certain information to be proprietary, and thus CAS numbers and other limited information may not be available for release.

In no event shall TI's liability arising out of such information exceed the total purchase price of the TI part(s) at issue in this document sold by TI to Customer on an annual basis.

TAPE AND REEL INFORMATION

QUADRANT ASSIGNMENTS FOR PIN 1 ORIENTATION IN TAPE

*All dimensions are nominal

Device	Package Type	Package Drawing	Pins	SPQ	Reel Diameter (mm)	Reel Width W1 (mm)	A0 (mm)	B0 (mm)	K0 (mm)	P1 (mm)	W (mm)	Pin1 Quadrant
SN74S1053DBR	SSOP	DB	20	2000	330.0	16.4	8.2	7.5	2.5	12.0	16.0	Q1
SN74S1053DWR	SOIC	DW	20	2000	330.0	24.4	10.8	13.3	2.7	12.0	24.0	Q1
SN74S1053NSR	SO	NS	20	2000	330.0	24.4	8.4	13.0	2.5	12.0	24.0	Q1
SN74S1053PWR	TSSOP	PW	20	2000	330.0	16.4	6.95	7.0	1.4	8.0	16.0	Q1

TAPE AND REEL BOX DIMENSIONS

*All dimensions are nominal

Device	Package Type	Package Drawing	Pins	SPQ	Length (mm)	Width (mm)	Height (mm)
SN74S1053DBR	SSOP	DB	20	2000	367.0	367.0	38.0
SN74S1053DWR	SOIC	DW	20	2000	367.0	367.0	45.0
SN74S1053NSR	SO	NS	20	2000	367.0	367.0	45.0
SN74S1053PWR	TSSOP	PW	20	2000	367.0	367.0	38.0

N (R-PDIP-T**)

PLASTIC DUAL-IN-LINE PACKAGE

16 PINS SHOWN



- NOTES:
- A. All linear dimensions are in inches (millimeters).
 - B. This drawing is subject to change without notice.
 - (C) Falls within JEDEC MS-001, except 18 and 20 pin minimum body length (Dim A).
 - (D) The 20 pin end lead shoulder width is a vendor option, either half or full width.

DW0020A



PACKAGE OUTLINE

SOIC - 2.65 mm max height

SOIC



4220724/A 05/2016

NOTES:

1. All linear dimensions are in millimeters. Dimensions in parenthesis are for reference only. Dimensioning and tolerancing per ASME Y14.5M.
2. This drawing is subject to change without notice.
3. This dimension does not include mold flash, protrusions, or gate burrs. Mold flash, protrusions, or gate burrs shall not exceed 0.15 mm per side.
4. This dimension does not include interlead flash. Interlead flash shall not exceed 0.43 mm per side.
5. Reference JEDEC registration MS-013.

EXAMPLE BOARD LAYOUT

DW0020A

SOIC - 2.65 mm max height

SOIC



LAND PATTERN EXAMPLE
SCALE:6X



SOLDER MASK DETAILS

4220724/A 05/2016

NOTES: (continued)

- 6. Publication IPC-7351 may have alternate designs.
- 7. Solder mask tolerances between and around signal pads can vary based on board fabrication site.

EXAMPLE STENCIL DESIGN

DW0020A

SOIC - 2.65 mm max height

SOIC



SOLDER PASTE EXAMPLE
BASED ON 0.125 mm THICK STENCIL
SCALE:6X

4220724/A 05/2016

NOTES: (continued)

8. Laser cutting apertures with trapezoidal walls and rounded corners may offer better paste release. IPC-7525 may have alternate design recommendations.
9. Board assembly site may have different recommendations for stencil design.

PW (R-PDSO-G20)

PLASTIC SMALL OUTLINE

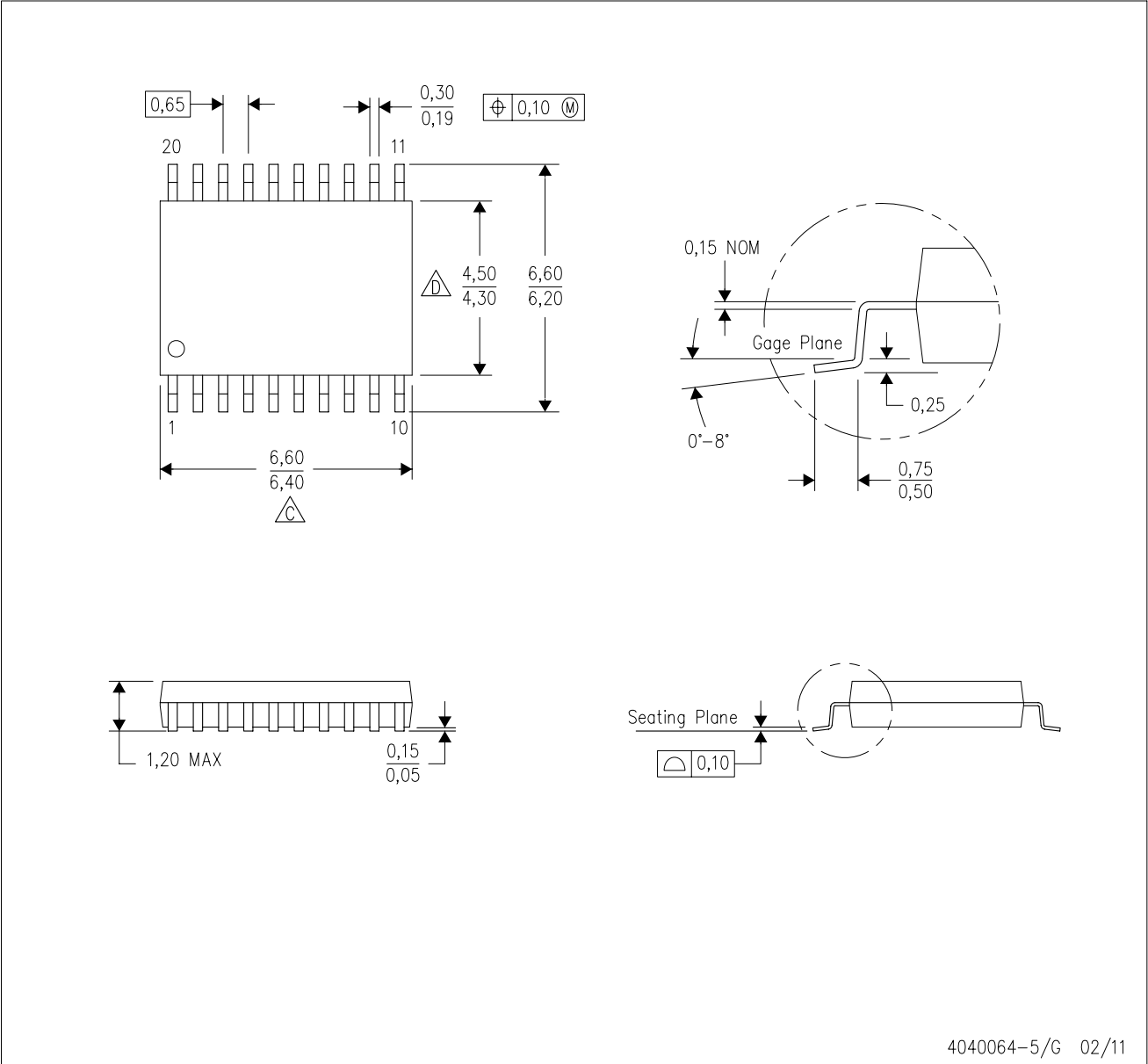

4040064-5/G 02/11

- NOTES:
- A. All linear dimensions are in millimeters. Dimensioning and tolerancing per ASME Y14.5M-1994.
 - B. This drawing is subject to change without notice.
 - C. Body length does not include mold flash, protrusions, or gate burrs. Mold flash, protrusions, or gate burrs shall not exceed 0,15 each side.
 - D. Body width does not include interlead flash. Interlead flash shall not exceed 0,25 each side.
 - E. Falls within JEDEC MO-153

PW (R-PDSO-G20)

PLASTIC SMALL OUTLINE



- NOTES:
- A. All linear dimensions are in millimeters.
 - B. This drawing is subject to change without notice.
 - C. Publication IPC-7351 is recommended for alternate design.
 - D. Laser cutting apertures with trapezoidal walls and also rounding corners will offer better paste release. Customers should contact their board assembly site for stencil design recommendations. Refer to IPC-7525 for other stencil recommendations.
 - E. Customers should contact their board fabrication site for solder mask tolerances between and around signal pads.

DB0020A



PACKAGE OUTLINE

SSOP - 2 mm max height

SMALL OUTLINE PACKAGE



4214851/B 08/2019

NOTES:

1. All linear dimensions are in millimeters. Any dimensions in parenthesis are for reference only. Dimensioning and tolerancing per ASME Y14.5M.
2. This drawing is subject to change without notice.
3. This dimension does not include mold flash, protrusions, or gate burrs. Mold flash, protrusions, or gate burrs shall not exceed 0.15 mm per side.
4. This dimension does not include interlead flash. Interlead flash shall not exceed 0.25 mm per side.
5. Reference JEDEC registration MO-150.

EXAMPLE BOARD LAYOUT

DB0020A

SSOP - 2 mm max height

SMALL OUTLINE PACKAGE



LAND PATTERN EXAMPLE
EXPOSED METAL SHOWN
SCALE: 10X



4214851/B 08/2019

NOTES: (continued)

6. Publication IPC-7351 may have alternate designs.
7. Solder mask tolerances between and around signal pads can vary based on board fabrication site.

EXAMPLE STENCIL DESIGN

DB0020A

SSOP - 2 mm max height

SMALL OUTLINE PACKAGE



SOLDER PASTE EXAMPLE
BASED ON 0.125 mm THICK STENCIL
SCALE: 10X

4214851/B 08/2019

NOTES: (continued)

8. Laser cutting apertures with trapezoidal walls and rounded corners may offer better paste release. IPC-7525 may have alternate design recommendations.
9. Board assembly site may have different recommendations for stencil design.

MECHANICAL DATA

NS (R-PDSO-G**)

PLASTIC SMALL-OUTLINE PACKAGE

14-PINS SHOWN



- NOTES:
- A. All linear dimensions are in millimeters.
 - B. This drawing is subject to change without notice.
 - C. Body dimensions do not include mold flash or protrusion, not to exceed 0,15.

IMPORTANT NOTICE AND DISCLAIMER

TI PROVIDES TECHNICAL AND RELIABILITY DATA (INCLUDING DATASHEETS), DESIGN RESOURCES (INCLUDING REFERENCE DESIGNS), APPLICATION OR OTHER DESIGN ADVICE, WEB TOOLS, SAFETY INFORMATION, AND OTHER RESOURCES "AS IS" AND WITH ALL FAULTS, AND DISCLAIMS ALL WARRANTIES, EXPRESS AND IMPLIED, INCLUDING WITHOUT LIMITATION ANY IMPLIED WARRANTIES OF MERCHANTABILITY, FITNESS FOR A PARTICULAR PURPOSE OR NON-INFRINGEMENT OF THIRD PARTY INTELLECTUAL PROPERTY RIGHTS.

These resources are intended for skilled developers designing with TI products. You are solely responsible for (1) selecting the appropriate TI products for your application, (2) designing, validating and testing your application, and (3) ensuring your application meets applicable standards, and any other safety, security, or other requirements. These resources are subject to change without notice. TI grants you permission to use these resources only for development of an application that uses the TI products described in the resource. Other reproduction and display of these resources is prohibited. No license is granted to any other TI intellectual property right or to any third party intellectual property right. TI disclaims responsibility for, and you will fully indemnify TI and its representatives against, any claims, damages, costs, losses, and liabilities arising out of your use of these resources.

TI's products are provided subject to TI's Terms of Sale (www.ti.com/legal/termsofsale.html) or other applicable terms available either on ti.com or provided in conjunction with such TI products. TI's provision of these resources does not expand or otherwise alter TI's applicable warranties or warranty disclaimers for TI products.

Mailing Address: Texas Instruments, Post Office Box 655303, Dallas, Texas 75265
Copyright © 2020, Texas Instruments Incorporated