

FEATURES

- Excellent sonic characteristics
- High output drive capability
- 5.2 nV/ $\sqrt{\text{Hz}}$ equivalent input noise @ 1 kHz
- 0.003% THD + N ($V_{\text{OUT}} = 1 \text{ V p-p}$ @ 1 kHz)
- 3.5 MHz gain bandwidth
- Unity-gain stable
- Low cost

APPLICATIONS

- Multimedia audio systems
- Microphone preamplifiers
- Headphone drivers
- Differential line receivers
- Balanced line drivers
- Audio ADC input buffers
- Audio DAC I-V converters and filters
- Pseudoground generators

GENERAL DESCRIPTION

The SSM2135 dual audio operational amplifier permits excellent performance in portable or low power audio systems, with an operating supply range of 4 V to 36 V or $\pm 2 \text{ V}$ to $\pm 18 \text{ V}$. The unity-gain stable device has very low voltage noise of 5.2 nV/ $\sqrt{\text{Hz}}$, and total harmonic distortion plus noise below 0.01% over normal signal levels and loads. Such characteristics are enhanced by wide output swing and load drive capability. A unique output stage permits output swing approaching the rail under moderate load conditions. Under severe loading, the SSM2135 still maintains a wide output swing with ultralow distortion. Particularly well suited for computer audio systems

and portable digital audio units, the SSM2135 can perform preamplification, headphone and speaker driving, and balanced line driving and receiving. Additionally, the device is ideal for input signal conditioning in single-supply, Σ - Δ , analog-to-digital converter subsystems such as the AD1877. The SSM2135 makes an ideal single-supply stereo output amplifier for audio digital-to-analog converters (DACs) because of its low noise and distortion.

The SSM2135 is available in an 8-lead plastic SOIC package and is guaranteed for operation over the extended industrial temperature range of -40°C to $+85^\circ\text{C}$.

PIN CONNECTIONS

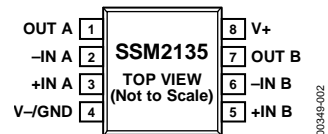

Figure 1. 8-Lead Narrow Body SOIC (R Suffix)

FUNCTIONAL BLOCK DIAGRAM

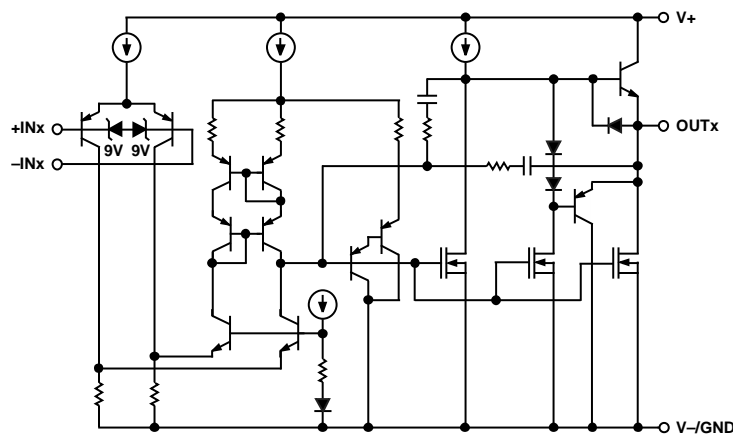

Figure 2.

Rev. G

Information furnished by Analog Devices is believed to be accurate and reliable. However, no responsibility is assumed by Analog Devices for its use, nor for any infringements of patents or other rights of third parties that may result from its use. Specifications subject to change without notice. No license is granted by implication or otherwise under any patent or patent rights of Analog Devices. Trademarks and registered trademarks are the property of their respective owners.

TABLE OF CONTENTS

Features	1
Applications.....	1
Pin Connections	1
General Description	1
Functional Block Diagram	1
Revision History	2
Specifications.....	3
Absolute Maximum Ratings.....	4

REVISION HISTORY

4/11—Rev. F to Rev. G

Changes to Figure 36.....	12
---------------------------	----

2/09—Rev. E to Rev. F

Updated Format.....	Universal
Changes to Features Section, General Description Section, and Figure 1 Caption	1
Changes to Specifications Section Conditions	3
Changed A_{VO} Symbol to A_V	3
Changes to Supply Current Parameter, Table 1	3
Deleted ESD Ratings Table.....	3
Changes to Figure 4 and Figure 5.....	5
Changes to Figure 9.....	6
Changes to Figure 15, Figure 13, and Figure 18	7
Changes to Figure 21, Figure 24 Caption, and Figure 25	8
Changes to Figure 27 and Figure 28.....	9
Deleted Figure 5; Renumbered Sequentially.....	10
Deleted 18-Bit Stereo CD-DAC Output Amplifier Section	10

Thermal Resistance	4
ESD Caution.....	4
Typical Performance Characteristics	5
Applications Information	10
Application Circuits	10
Outline Dimensions	14
Ordering Guide	14

Changes to Applications Information Section, Low Noise Stereo Headphone Driver Amplifier Section, Figure 31, and Figure 32	10
Changes to Low Noise Microphone Preamplifier Section, Figure 33, and Figure 34	11
Changes to Figure 37.....	12
Deleted Spice Macromodel Section	12
Changes to Digital Volume Control Circuit Section, Figure 38, and Figure 39.....	13
Updated Outline Dimensions.....	14
Changes to Ordering Guide.....	14

2/03—Rev. D to Rev. E

Removed 8-Lead Plastic DIP Package	Universal
Edits to Thermal Characteristics.....	4
Edits to Outline Dimensions.....	14
Updated Ordering Guide	14

SPECIFICATIONS

$V_S = 5\text{ V}$, $-40^\circ\text{C} \leq T_A \leq +85^\circ\text{C}$, unless otherwise noted. Typical specifications apply at $T_A = 25^\circ\text{C}$.

Table 1.

Parameter	Symbol	Conditions	Min	Typ	Max	Unit
AUDIO PERFORMANCE						
Voltage Noise Density	e_n	$f = 1\text{ kHz}$		5.2		$\text{nV}/\sqrt{\text{Hz}}$
Current Noise Density	i_n	$f = 1\text{ kHz}$		0.5		$\text{pA}/\sqrt{\text{Hz}}$
Signal-To-Noise Ratio	SNR	20 Hz to 20 kHz, 0 dBu = 0.775 V rms		121		dBu
Headroom	HR	Clip point = 1% THD + N, $f = 1\text{ kHz}$, $R_L = 10\text{ k}\Omega$		5.3		dBu
Total Harmonic Distortion Plus Noise	THD + N	$A_V = +1$, $V_{\text{OUT}} = 1\text{ V p-p}$, $f = 1\text{ kHz}$, 80 kHz LPF $R_L = 10\text{ k}\Omega$		0.003		%
				0.005		%
DYNAMIC PERFORMANCE						
Slew Rate	SR	$R_L = 2\text{ k}\Omega$, $T_A = 25^\circ\text{C}$	0.6	0.9		$\text{V}/\mu\text{s}$
Gain Bandwidth Product	GBW			3.5		MHz
Settling Time	t_s	To 0.1%, 2 V Step		5.8		μs
INPUT CHARACTERISTICS						
Input Voltage Range	V_{CM}		0		4.0	V
Input Offset Voltage	V_{OS}	$V_{\text{OUT}} = 2\text{ V}$		0.2	2.0	mV
Input Bias Current	I_B	$V_{\text{CM}} = 0\text{ V}$, $V_{\text{OUT}} = 2\text{ V}$		300	750	nA
Input Offset Current	I_{OS}	$V_{\text{CM}} = 0\text{ V}$, $V_{\text{OUT}} = 2\text{ V}$			50	nA
Differential Input Impedance	Z_{IN}			4		$\text{M}\Omega$
Common-Mode Rejection	CMR	$0\text{ V} \leq V_{\text{CM}} \leq 4\text{ V}$, $f = \text{dc}$	87	112		dB
Large Signal Voltage Gain	A_V	$0.01\text{ V} \leq V_{\text{OUT}} \leq 3.9\text{ V}$, $R_L = 600\ \Omega$	2			$\text{V}/\mu\text{V}$
OUTPUT CHARACTERISTICS						
Output Voltage Swing High	V_{OH}	$R_L = 100\text{ k}\Omega$	4.1			V
		$R_L = 600\ \Omega$	3.9			V
Output Voltage Swing Low	V_{OL}	$R_L = 100\text{ k}\Omega$			3.5	mV
		$R_L = 600\ \Omega$			3.0	mV
Short-Circuit Current Limit	I_{SC}			± 30		mA
POWER SUPPLY						
Supply Voltage Range	V_S	Single supply	4		36	V
		Dual supply	± 2		± 18	V
Power Supply Rejection Ratio	PSRR	$V_S = 4\text{ V to }6\text{ V}$, $f = \text{dc}$	90	120		dB
Supply Current	I_{SY}	$V_S = 5\text{ V}$, $V_{\text{OUT}} = 2.0\text{ V}$, no load		2.8	6.0	mA
		$V_S = \pm 18\text{ V}$, $V_{\text{OUT}} = 0\text{ V}$, no load		3.7	7.6	mA

ABSOLUTE MAXIMUM RATINGS

Table 2.

Parameter	Rating
Supply Voltage	
Single Supply	36 V
Dual Supply	± 18 V
Input Voltage	$\pm V_S$
Differential Input Voltage	10 V
Output Short-Circuit Duration	Indefinite
Storage Temperature Range	-65°C to $+150^{\circ}\text{C}$
Operating Temperature Range	-40°C to $+85^{\circ}\text{C}$
Junction Temperature Range (T_J)	-65°C to $+150^{\circ}\text{C}$
Lead Temperature (Soldering, 60 sec)	300°C

Stresses above those listed under Absolute Maximum Ratings may cause permanent damage to the device. This is a stress rating only; functional operation of the device at these or any other conditions above those indicated in the operational section of this specification is not implied. Exposure to absolute maximum rating conditions for extended periods may affect device reliability.

THERMAL RESISTANCE

θ_{JA} is specified for the worst-case conditions, that is, a device soldered in a circuit board for surface-mount packages.

Table 3.

Package Type	θ_{JA}	θ_{JC}	Unit
8-Lead SOIC (R-8)	158	43	$^{\circ}\text{C}/\text{W}$

ESD CAUTION



ESD (electrostatic discharge) sensitive device. Charged devices and circuit boards can discharge without detection. Although this product features patented or proprietary protection circuitry, damage may occur on devices subjected to high energy ESD. Therefore, proper ESD precautions should be taken to avoid performance degradation or loss of functionality.

TYPICAL PERFORMANCE CHARACTERISTICS

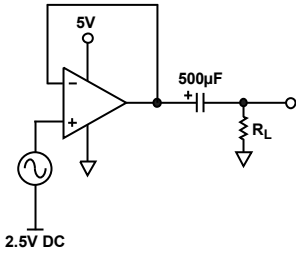

Figure 3. Test Circuit for Figure 4, Figure 5, and Figure 6

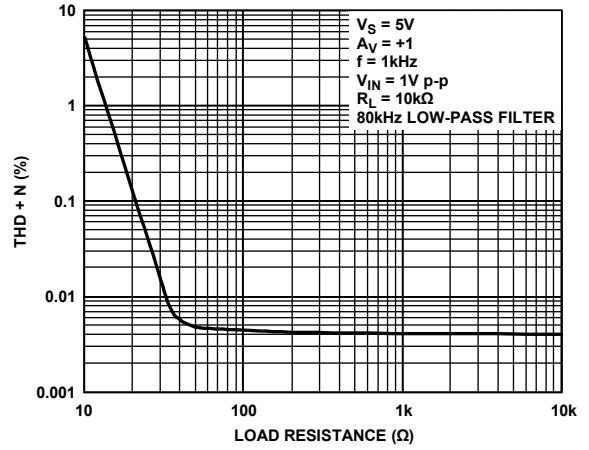

Figure 6. THD + N vs. Load (See Figure 3)

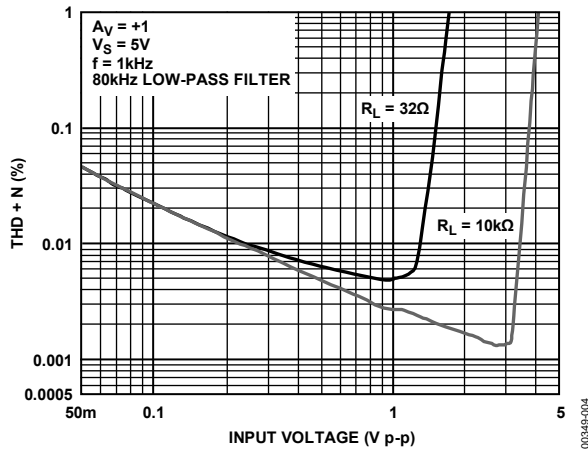

Figure 4. THD + N vs. Amplitude (See Figure 3)

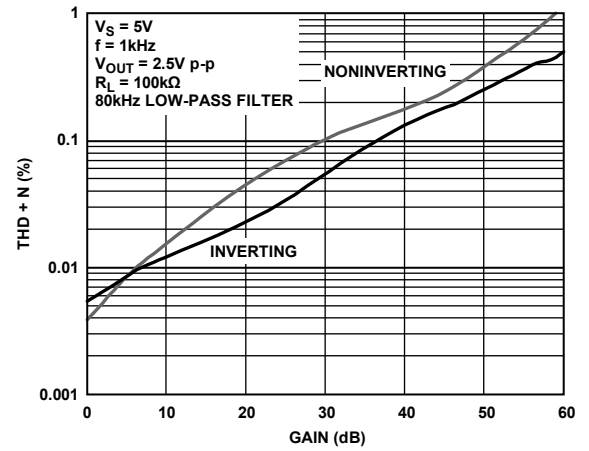

Figure 7. THD + N vs. Gain

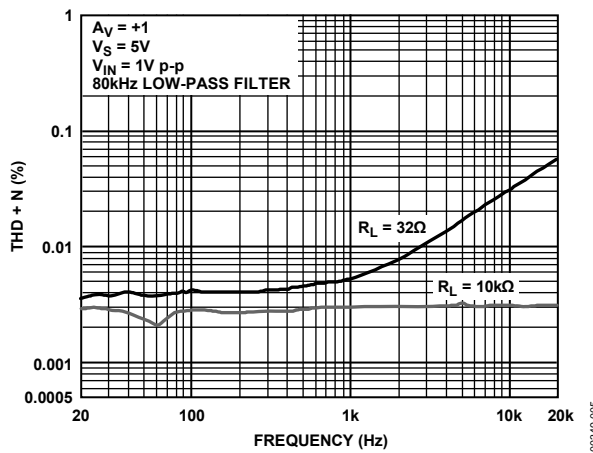

Figure 5. THD + N vs. Frequency (See Figure 3)

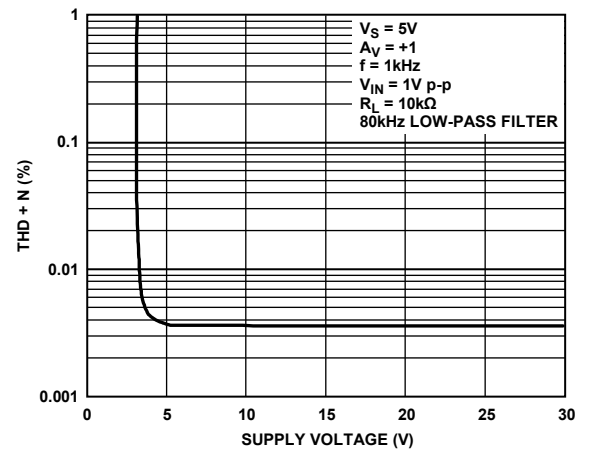

Figure 8. THD + N vs. Supply Voltage

SSM2135

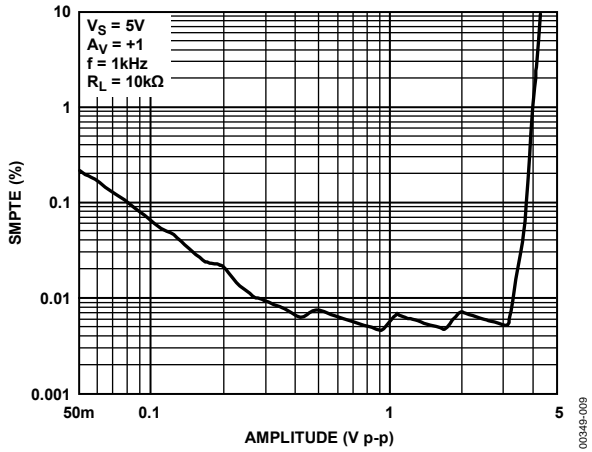

Figure 9. SMPTE Intermodulation Distortion

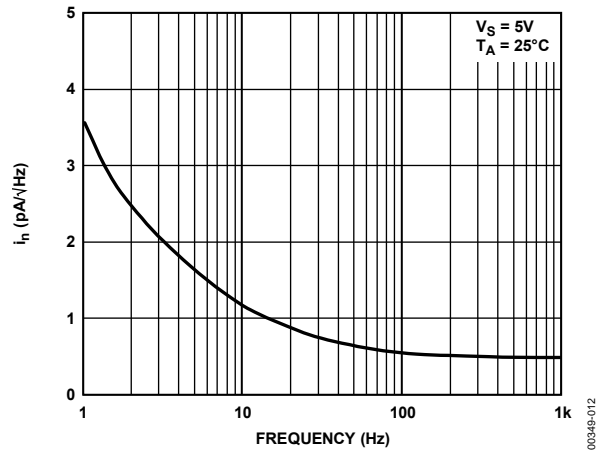

Figure 12. Current Noise Density vs. Frequency

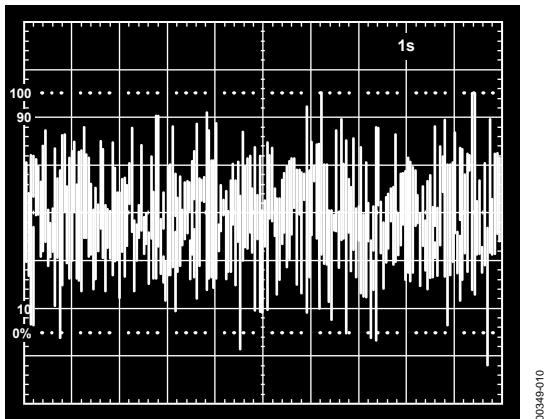

Figure 10. Input Voltage Noise (20 nV/Div)

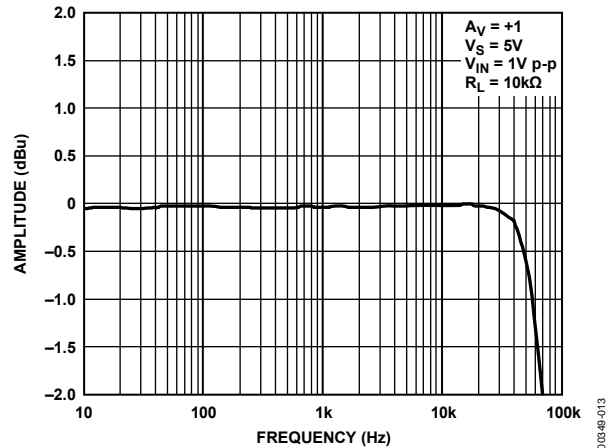

Figure 13. Frequency Response

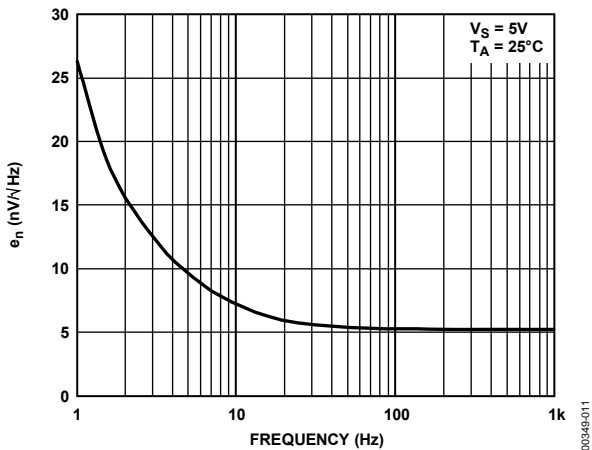

Figure 11. Voltage Noise Density vs. Frequency

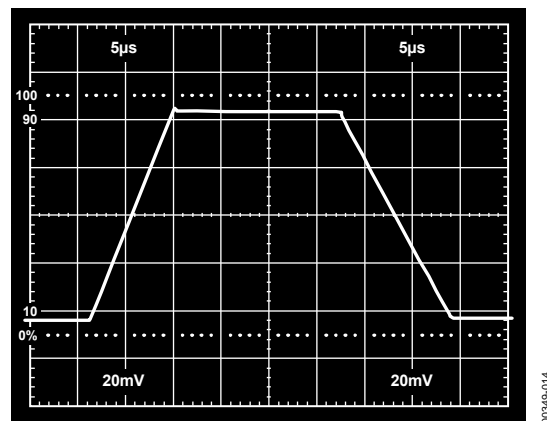

Figure 14. Square Wave Response ($V_S = 5V$, $A_V = +1$, $R_L = \infty$)

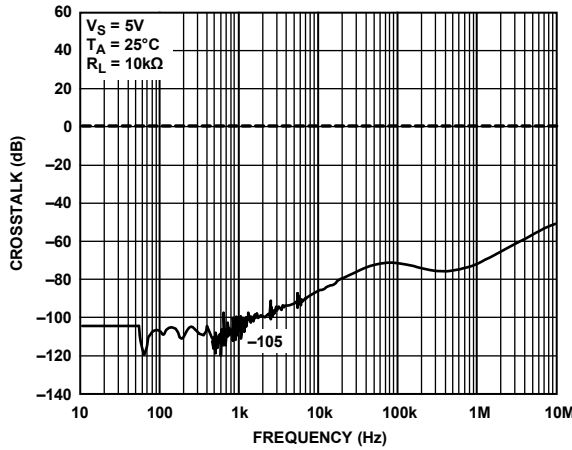

Figure 15. Crosstalk vs. Frequency

00349-015

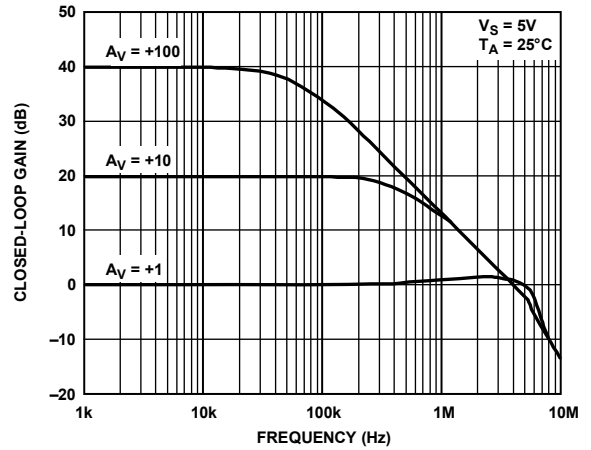

Figure 18. Closed-Loop Gain vs. Frequency

00349-018

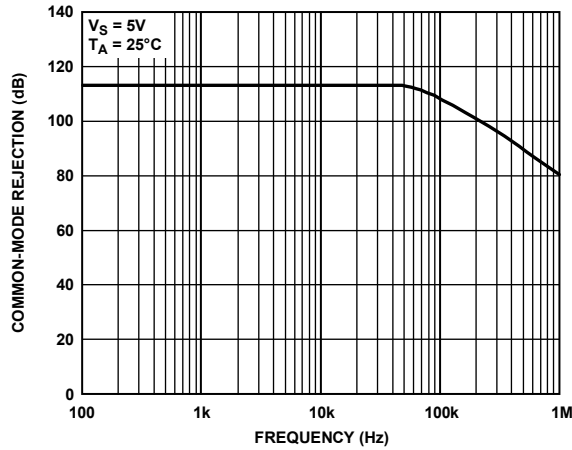

Figure 16. Common-Mode Rejection vs. Frequency

00349-016

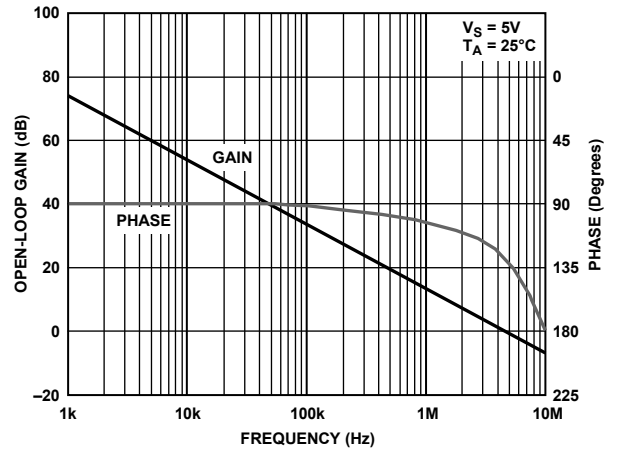

Figure 19. Open-Loop Gain and Phase vs. Frequency

00349-019

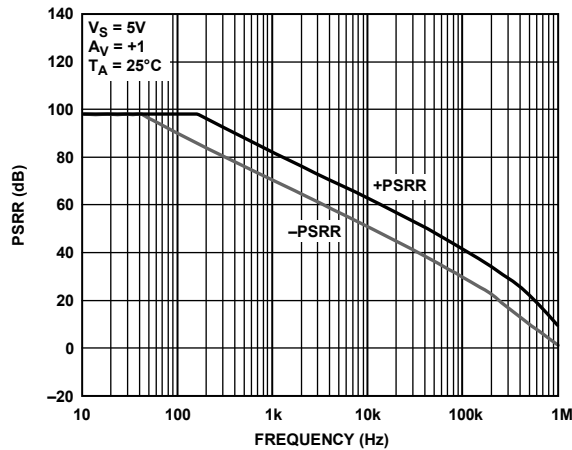

Figure 17. Power Supply Rejection Ratio vs. Frequency

00349-017

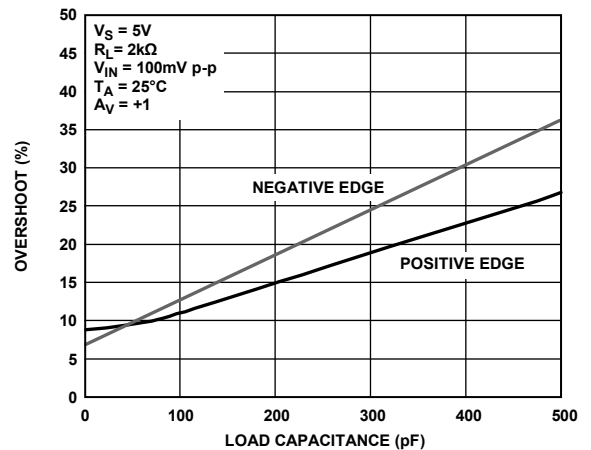

Figure 20. Small Signal Overshoot vs. Load Capacitance

00349-020

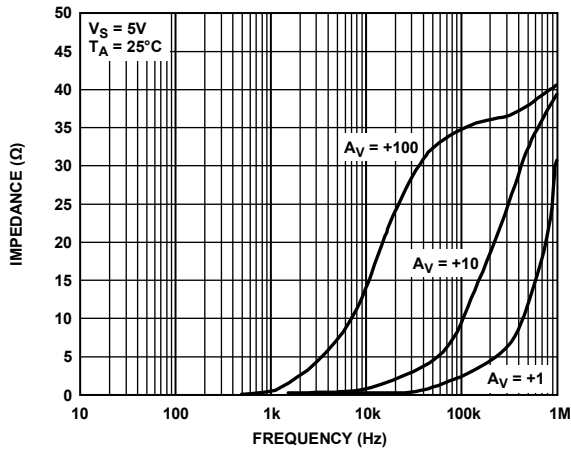

Figure 21. Output Impedance vs. Frequency

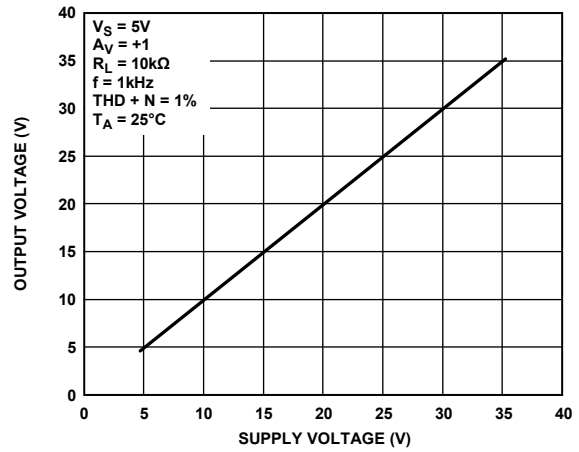

Figure 24. Output Voltage vs. Supply Voltage

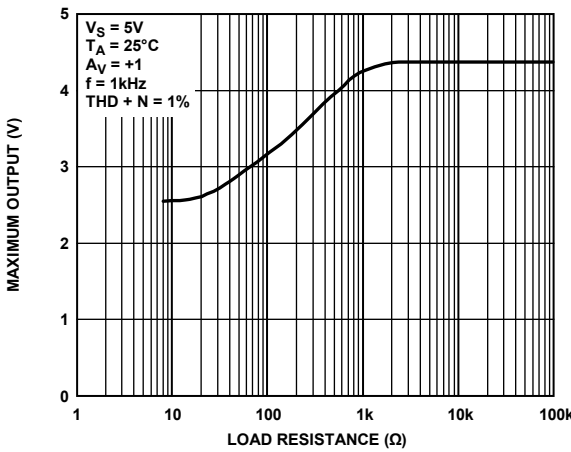

Figure 22. Maximum Output Voltage vs. Load Resistance

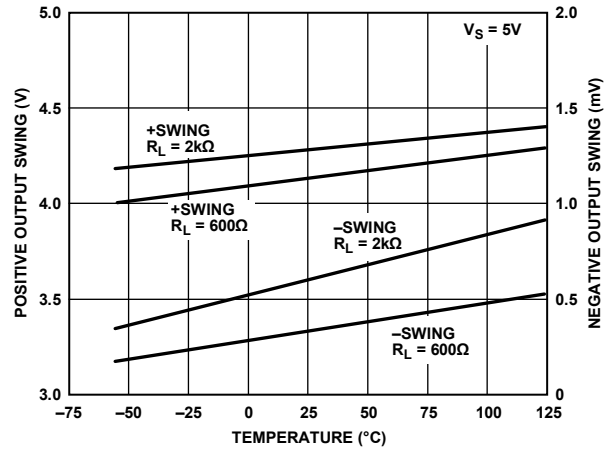

Figure 25. Output Swing vs. Temperature and Load

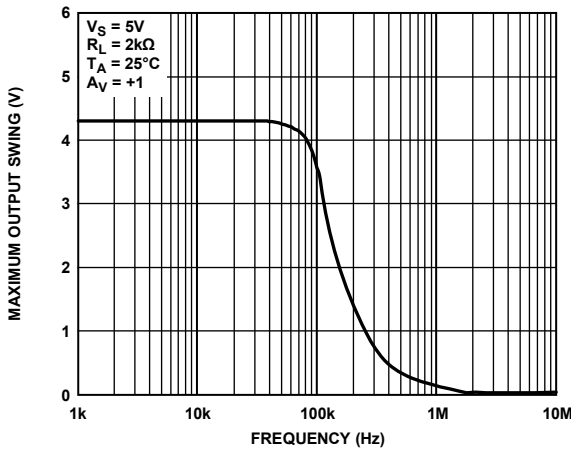

Figure 23. Maximum Output Swing vs. Frequency

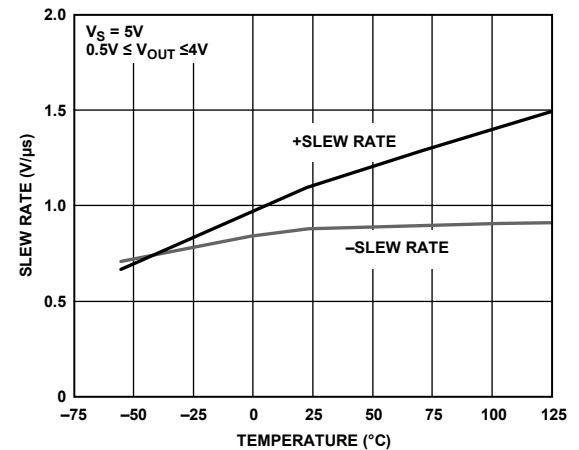

Figure 26. Slew Rate vs. Temperature

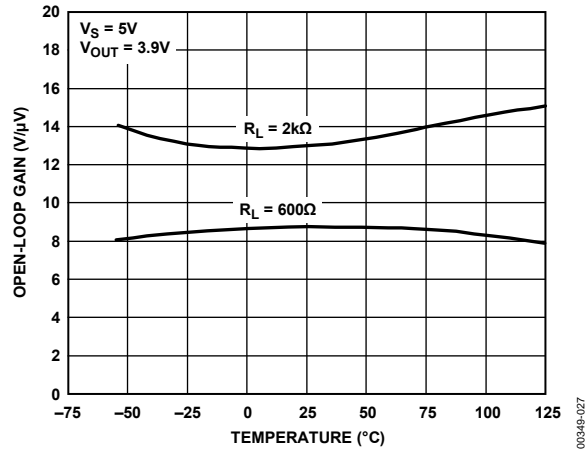

Figure 27. Open-Loop Gain vs. Temperature

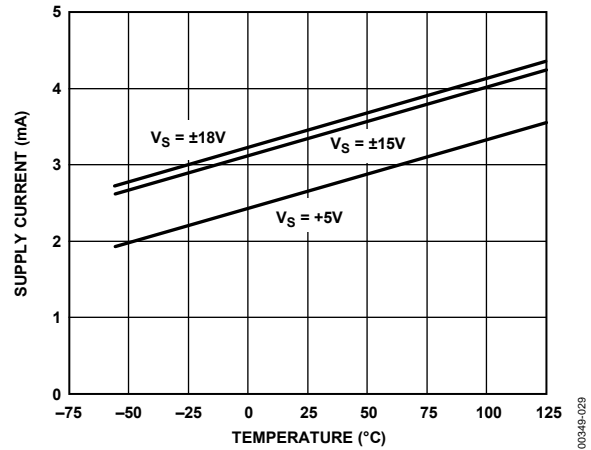

Figure 29. Supply Current vs. Temperature

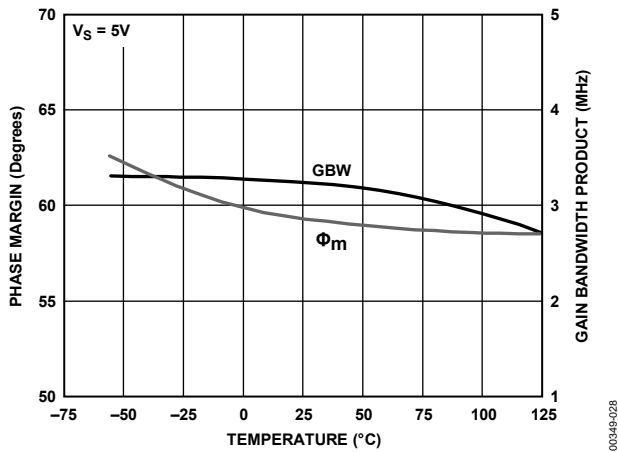

Figure 28. Gain Bandwidth Product and Phase Margin vs. Temperature

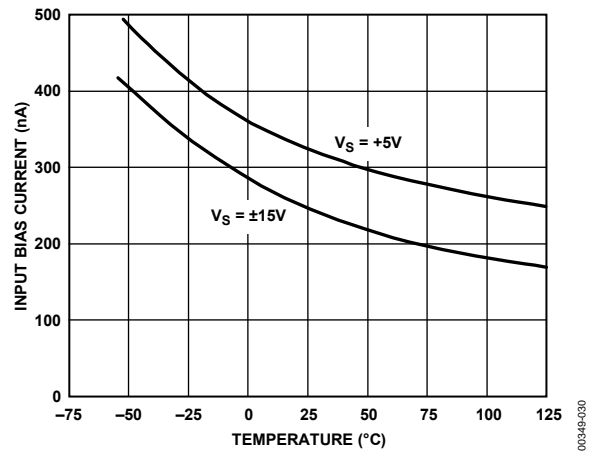

Figure 30. Input Bias Current vs. Temperature

APPLICATIONS INFORMATION

The SSM2135 is a low voltage audio amplifier that has exceptionally low noise and excellent sonic quality even when driving loads as small as 25 Ω . Designed for single supply use, the inputs and output can both swing very close to 0 V. Thus with a supply voltage at 5 V, both the input and output swing from 0 V to 4 V. Because of this, signal dynamic range can be optimized if the amplifier is biased to a 2 V reference rather than at half the supply voltage.

The SSM2135 is unity-gain stable, even when driving into a fair amount of capacitive load. Driving up to 500 pF does not cause any instability in the amplifier. However, overshoot in the frequency response increases slightly.

The SSM2135 makes an excellent output amplifier for 5 V only audio systems such as a multimedia workstation, a CD output amplifier, or an audio mixing system. The amplifier has large output swing even at this supply voltage because it is designed to swing to the negative rail. In addition, it easily drives load impedances as low as 25 Ω with low distortion.

The SSM2135 is fully protected from phase reversal for inputs going to the negative supply rail. However, internal ESD protection diodes turn on when either input is forced more than 0.5 V below the negative rail. Under this condition, input current in excess of 2 mA may cause erratic output behavior, in which case, a current limiting resistor should be included in the offending input if phase integrity is required with excessive input voltages. A 500 Ω or higher series input resistor prevents phase inversion even with the input pulled 1 V below the negative supply.

Hot plugging the input to a signal generally does not present a problem for the SSM2135, assuming that the signal does not have any voltage exceeding the supply voltage of the device. If so, it is advisable to add a series input resistor to limit the current, as well as a Zener diode to clamp the input to a voltage no higher than the supply.

APPLICATION CIRCUITS

Low Noise Stereo Headphone Driver Amplifier

Figure 31 shows the SSM2135 used in a stereo headphone driver for multimedia applications with the AD1845, a 16-bit stereo codec. The SSM2135 is equally well suited for the serial-based AD1849 stereo codec. The impedance of the headphone can be as low as 25 Ω , which covers most commercially available high fidelity headphones. Although the amplifier can operate at up to ± 18 V supply, it is just as efficient powered by a single 5 V. At this voltage, the amplifier has sufficient output drive to deliver distortion-free sound to a low impedance headphone.

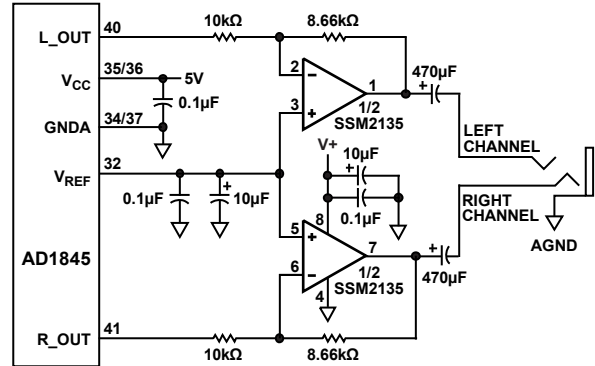

Figure 31. A Stereo Headphone Driver for Multimedia Sound Codec

Figure 32 shows the total harmonic distortion characteristics vs. frequency driving into a 32 Ω load, which is a very typical impedance for a high quality stereo headphone. The SSM2135 has excellent power supply rejection, and, as a result, is tolerant of poorly regulated supplies. However, for best sonic quality, the power supply should be well regulated and heavily bypassed to minimize supply modulation under heavy loads. A minimum of 10 μ F bypass is recommended.

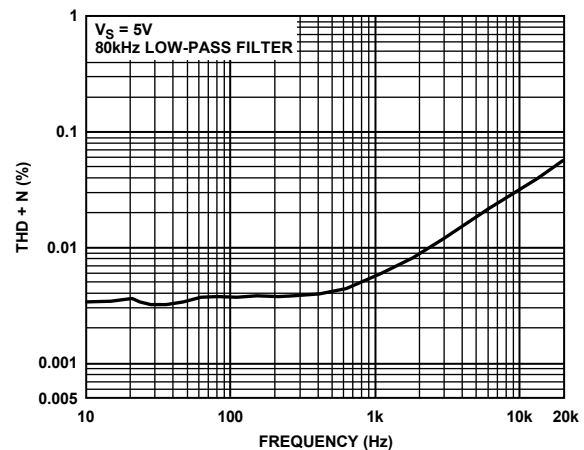

Figure 32. Headphone Driver THD + N vs. Frequency into a 32 Ω Load

Low Noise Microphone Preamplifier

The 5.2 nV/ $\sqrt{\text{Hz}}$ input noise in conjunction with low distortion make the SSM2135 an ideal device for amplifying low level signals such as those produced by microphones. Figure 34 illustrates a stereo microphone input circuit feeding a multimedia sound codec. The gain is set at 100 (40 dB), although it can be set to other gains depending on the microphone output levels. Figure 33 shows the harmonic distortion performance of the preamplifier with 1 V rms output, while operating from a single 5 V supply.

The SSM2135 is biased to 2.25 V by the V_{REF} pin of the AD1845 codec. The same voltage is buffered by the 2N4124 transistor to provide phantom power to the microphone. A typical electrets condenser microphone with an impedance range of 100 Ω to 1 k Ω works well with the circuit. This power booster circuit can be omitted for dynamic microphone elements.

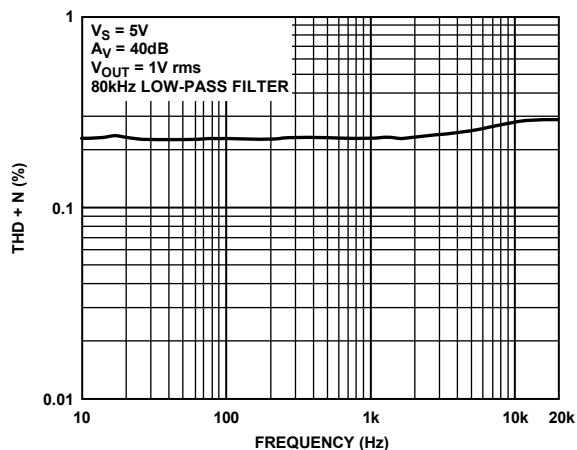

Figure 33. MIC Preamp THD + N Performance

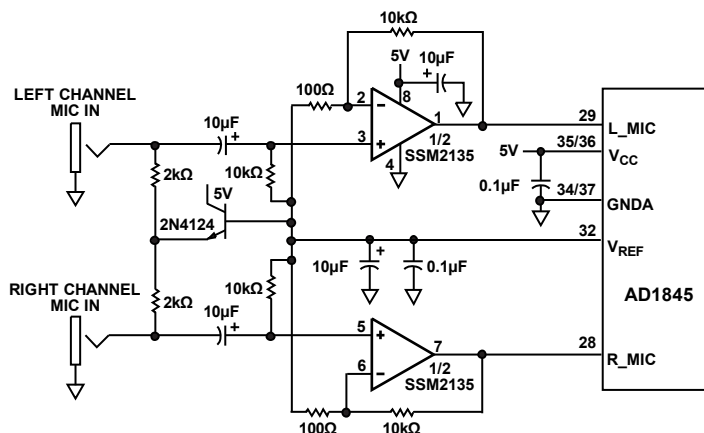

Figure 34. Low Noise Microphone Preamp for Multimedia Sound Codec

SSM2135

Single Supply Differential Line Driver

Signal distribution and routing is often required in audio systems, particularly portable digital audio equipment for professional applications. Figure 35 shows a single-supply line driver circuit that has differential output. The bottom amplifier provides a 2 V dc bias for the differential amplifier to maximize the output swing range. The amplifier can output a maximum of 0.8 V rms signal with a 5 V supply. It is capable of driving into 600 Ω line termination at a reduced output amplitude.

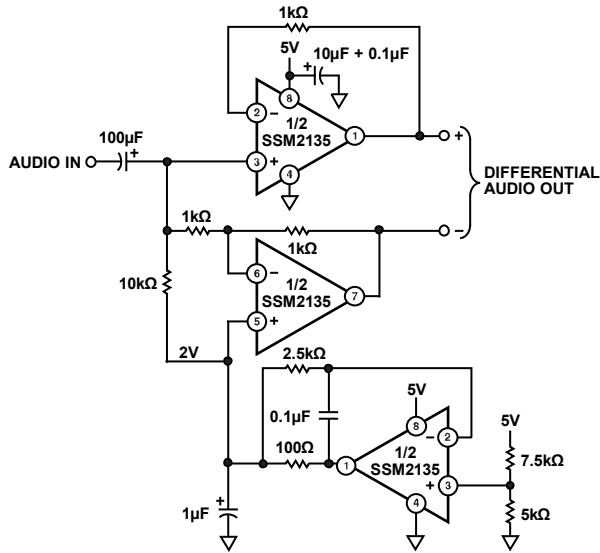

Figure 35. Single-Supply Differential Line Driver

Single-Supply Differential Line Receiver

Receiving a differential signal with minimum distortion is achieved using the circuit in Figure 36. Unlike a difference amplifier (a subtractor), the circuit has a true balanced input impedance regardless of input drive levels; that is, each input always presents a 20 kΩ impedance to the source. For best common-mode rejection performance, all resistors around the differential amplifier must be very well matched. Best results can be achieved using a 10 kΩ precision resistor network.

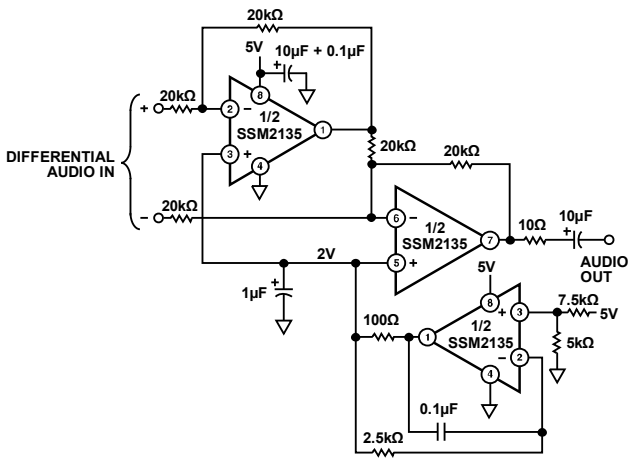

Figure 36. Single-Supply Balanced Differential Line Receiver

Pseudoreference Voltage Generator

For single-supply circuits, a reference voltage source is often required for biasing purposes or signal offsetting purposes. The circuit in Figure 37 provides a supply splitter function with low output impedance. The 1 µF output capacitor serves as a charge reservoir to handle a sudden surge in demand by the load as well as providing a low ac impedance to it. The 0.1 µF feedback capacitor compensates the amplifier in the presence of a heavy capacitive load, maintaining stability.

The output can source or sink up to 12 mA of current with a 5 V supply, limited only by the 100 Ω output resistor. Reducing the resistance increases the output current capability. Alternatively, increasing the supply voltage to 12 V also improves the output drive to more than 25 mA.

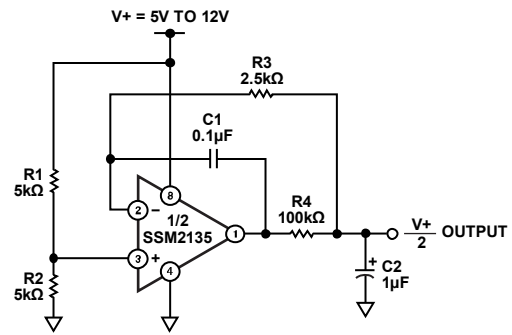

Figure 37. Pseudoreference Generator

00349-036

00349-038

00349-037

Digital Volume Control Circuit

Working in conjunction with the AD7528 dual 8-bit DAC, the SSM2135 makes an efficient audio attenuator, as shown in Figure 38. The circuit works off a single 5 V supply. The DACs are biased to a 2 V reference level, which is sufficient to keep the internal R-2R ladder switches of the DACs operating properly. This voltage is also the optimal midpoint of the SSM2135 common-mode and output swing range. With the circuit as shown in Figure 38, the maximum input and output swing is 1.25 V rms. Total harmonic distortion measures a respectable 0.01% at 1 kHz and 0.1% at 20 kHz. The frequency response at any attenuation level is flat to 20 kHz.

Each DAC can be controlled independently via the 8-bit parallel data bus. The attenuation level is linearly controlled by the binary weighting of the digital data input. Total attenuation ranges from 0 dB to 48 dB.

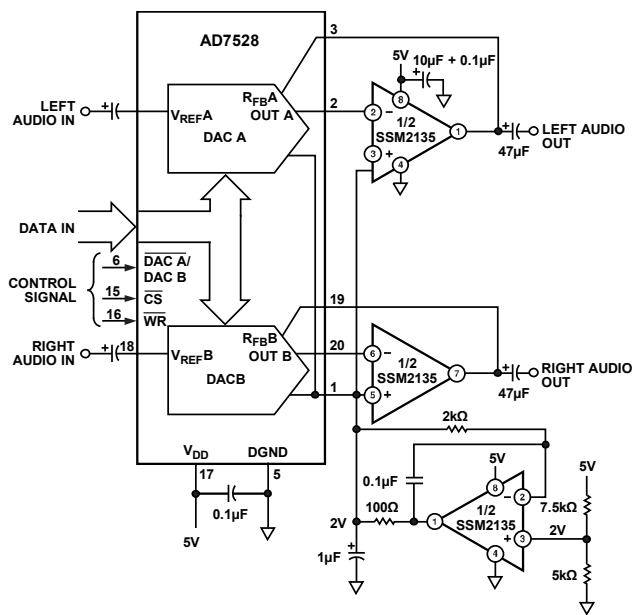

Figure 38. Digital Volume Control

Logarithmic Volume Control Circuit

Figure 39 shows a logarithmic version of the volume control function. Similar biasing is used. With an 8-bit bus, the AD7111 provides an 88.5 dB attenuation range. Each bit resolves a 0.375 dB attenuation. Refer to the AD7111 data sheet for attenuation levels for each input code.

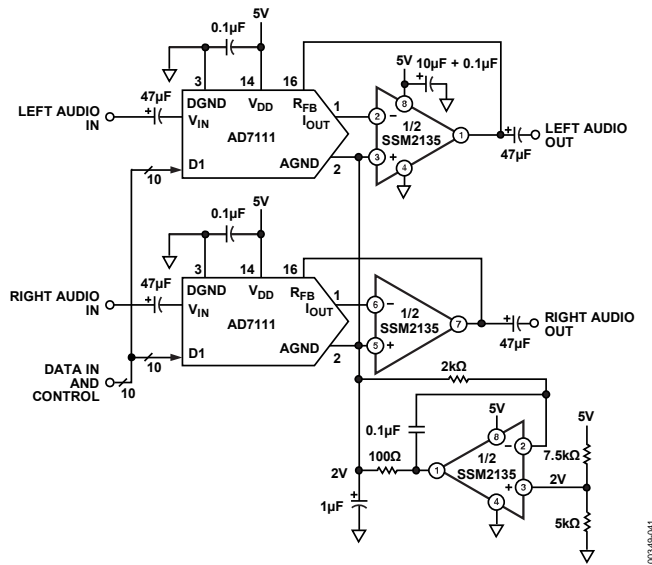
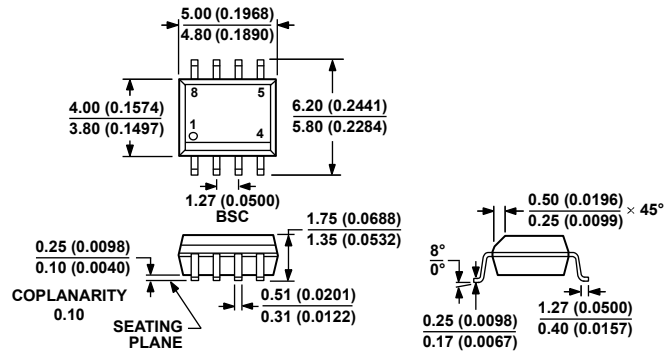

Figure 39. Single-Supply Logarithmic Volume Control

SSM2135

OUTLINE DIMENSIONS



COMPLIANT TO JEDEC STANDARDS MS-012-AA
 CONTROLLING DIMENSIONS ARE IN MILLIMETERS; INCH DIMENSIONS
 (IN PARENTHESES) ARE ROUNDED-OFF MILLIMETER EQUIVALENTS FOR
 REFERENCE ONLY AND ARE NOT APPROPRIATE FOR USE IN DESIGN.

012407-A

Figure 40. 8-Lead Standard Small Outline Package [SOIC_N]
 Narrow Body
 (R-8)

Dimensions shown in millimeters and (inches)

ORDERING GUIDE

Model ¹	Temperature Range	Package Description	Package Option
SSM2135S	-40°C to +85°C	8-Lead SOIC_N	R-8
SSM2135S-REEL	-40°C to +85°C	8-Lead SOIC_N	R-8
SSM2135S-REEL7	-40°C to +85°C	8-Lead SOIC_N	R-8
SSM2135SZ	-40°C to +85°C	8-Lead SOIC_N	R-8
SSM2135SZ-REEL	-40°C to +85°C	8-Lead SOIC_N	R-8
SSM2135SZ-REEL7	-40°C to +85°C	8-Lead SOIC_N	R-8

¹ Z = RoHS Compliant Part.

NOTES

SSM2135

NOTES

Mouser Electronics

Authorized Distributor

Click to View Pricing, Inventory, Delivery & Lifecycle Information:

[Analog Devices Inc.:](#)

[SSM2135S-REEL7](#) [SSM2135S](#) [SSM2135SZ-REEL7](#) [SSM2135S-REEL](#) [SSM2135SZ](#) [SSM2135SZ-REEL](#)