

THIS DOCUMENT IS THE PROPERTY OF  
KEYSTONE ELECTRONICS CORP. AND  
SHALL NOT BE REPRODUCED, DISTRIBUTED  
OR USED AS A BASIS FOR MANUFACTURE  
WITHOUT PRIOR WRITTEN PERMISSION  
FROM KEYSTONE ELECTRONICS CORP.

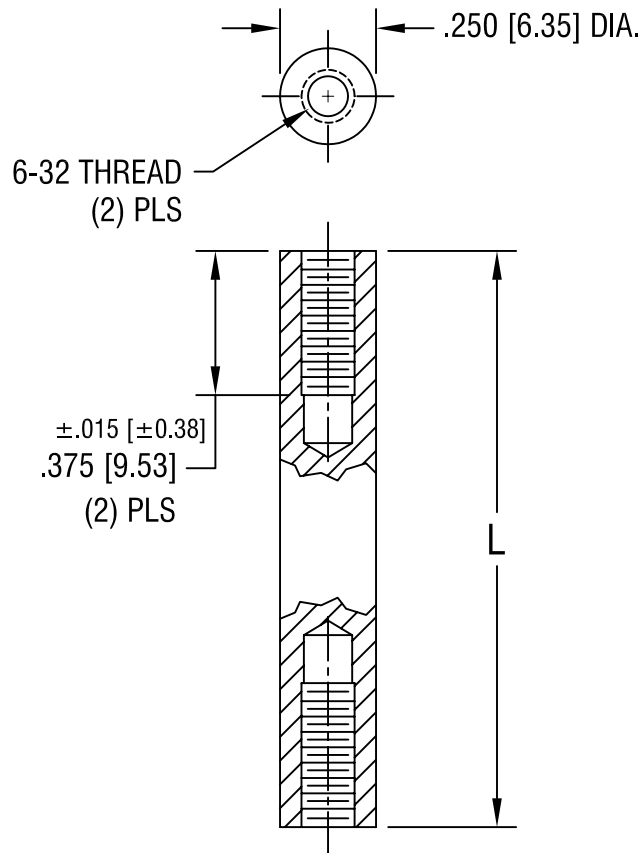

PART NO.	'L' DIM.
1855	1.750 [44.50]
1856	2.250 [57.15]
1857	2.500 [63.50]

**KEYSTONE ELECTRONICS CORP.**

ASTORIA, N.Y. 11105-2017

PART NAME

THREADED ROUND STANDOFF

MATERIAL

ALUMINUM

FINISH

CLEAR IRIDITE

DRN BY

BOONE

DATE

3.11.98

APP'D

LN

SCALE

2X

TOLERANCES

INCH [MM]

DECIMAL ±.005 [± 0.15]

ANGULAR ± 1°  
UNLESS OTHERWISE SPECIFIED

CODE

DWG NO.

C/M

1855-1857

DATE

DESCRIPTION

REV.

# Mouser Electronics

Authorized Distributor

Click to View Pricing, Inventory, Delivery & Lifecycle Information:

[Keystone Electronics:](#)

[1856](#)