

FEATURES

- Four Independent PSE Channels
- Compliant with IEEE 802.3at Type 1 and 2
- Low Power Dissipation
 - 0.25Ω Sense Resistance Per Channel
- Very High Reliability 4-Point PD Detection
 - 2-Point Forced Voltage
 - 2-Point Forced Current
- High Capacitance Legacy Device Detection
- 1MHz I²C Compatible Serial Control Interface
- Midspan Backoff Timer
- Supports 2-Pair and 4-Pair Output Power
- Available in Multiple Power Grades
 - LTC4266A-1: LTPoE++™ 38.7W
 - LTC4266A-2: LTPoE++ 52.7W
 - LTC4266A-3: LTPoE++ 70W
 - LTC4266A-4: LTPoE++ 90W
 - LTC4266C: PoE 13W
- Available in 38-Lead 5mm × 7mm QFN Package

APPLICATIONS

- LTPoE++ PSE Switches/Routers
- LTPoE++ PSE Midspans
- IEEE 802.3at Type 1 PSE Switches/Routers
- IEEE 802.3at Type 1 PSE Midspans

LT, LT, LTC, LTM, Linear Technology and the Linear logo are registered trademarks and LTPoE++ and ThinSOT are trademarks of Analog Devices, Inc. All other trademarks are the property of their respective owners.

DESCRIPTION

The LTC[®]4266A is a quad power sourcing equipment (PSE) controller capable of delivering up to 90W of LTPoE++ power to a compatible LTPoE++ powered device (PD). A proprietary detection/classification scheme allows mutual identification between a LTPoE++ PSE and LTPoE++ PD while remaining compatible and interoperable with existing Type 1 (13W) and Type 2 (25.5W) PDs. The LTC4266A feature set is a superset of the popular LTC4266. These PSE controllers feature low R_{ON} external MOSFETs and 0.25Ω sense resistors which are especially important at the LTPoE++ current levels to maintain the lowest possible heat dissipation.

The LTC4266C targets fully automatic PSE systems powering Type 1 (up to 13W) PDs.

Advanced power management features include: 14-bit current monitoring ADCs, DAC-programmable current limit, and versatile quick shutdown of preselected ports. Advanced power management host software is available under a no-cost license. PD discovery uses a proprietary dual-mode 4-point detection mechanism ensuring excellent immunity from false PD detection. The LTC4266 includes an I²C serial interface operable up to 1MHz.

The LTC4266 is available in multiple power grades allowing delivered PD power of 13W, 25.5W, 38.7W, 52.7W, 70W and 90W. These controllers are available in a 38-lead 5mm × 7mm QFN package.

TYPICAL APPLICATION

Complete 4-Port Ethernet High Power Source



LTC4266A/LTC4266C

ABSOLUTE MAXIMUM RATINGS

Supply Voltages (Note 1)

AGND – V _{EE}	–0.3V to 80V
DGND – V _{EE}	–0.3V to 80V
V _{DD} – DGND	–0.3V to 5.5V

Digital Pins

SCL, SDAIN, SDAOUT, $\overline{\text{INT}}$, $\overline{\text{SHDN}}_n$, $\overline{\text{MSD}}$, AD_n,
RESET, AUTO, MID..... DGND –0.3V to V_{DD} + 0.3V

Analog Pins

GATE_n, SENSE_n, OUT_n V_{EE} –0.3V to V_{EE} + 80V

Operating Temperature Range

LTC4266I –40°C to 85°C

Junction Temperature (Note 2) 125°C

Storage Temperature Range –65°C to 150°C

Lead Temperature (Soldering, 10 sec)..... 300°C

PIN CONFIGURATION

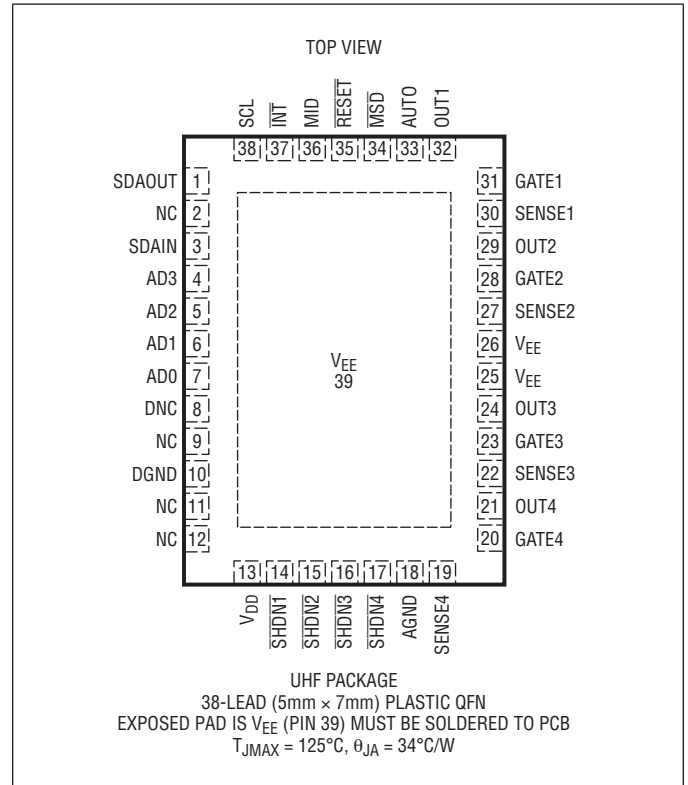

ORDER INFORMATION <http://www.linear.com/product/LTC4266A#orderinfo>

LEAD FREE FINISH	TAPE AND REEL	PART MARKING*	PACKAGE DESCRIPTION	MAX PWR	TEMPERATURE RANGE
LTC4266CIUHF#PBF	LTC4266CIUHF#TRPBF	4266C	38-Lead (5mm × 7mm) Plastic QFN	13W	–40°C to 85°C
LTC4266AIUHF-1#PBF	LTC4266AIUHF-1#TRPBF	4266A1	38-Lead (5mm × 7mm) Plastic QFN	38.7W	–40°C to 85°C
LTC4266AIUHF-2#PBF	LTC4266AIUHF-2#TRPBF	4266A2	38-Lead (5mm × 7mm) Plastic QFN	52.7W	–40°C to 85°C
LTC4266AIUHF-3#PBF	LTC4266AIUHF-3#TRPBF	4266A3	38-Lead (5mm × 7mm) Plastic QFN	70W	–40°C to 85°C
LTC4266AIUHF-4#PBF	LTC4266AIUHF-4#TRPBF	4266A4	38-Lead (5mm × 7mm) Plastic QFN	90W	–40°C to 85°C

Consult LTC Marketing for parts specified with wider operating temperature ranges. *The temperature grade is identified by a label on the shipping container. Consult LTC Marketing for information on non-standard lead based finish parts.

For more information on lead free part marking, go to: <http://www.linear.com/leadfree/>

For more information on tape and reel specifications, go to: <http://www.linear.com/tapeandree/>. Some packages are available in 500 unit reels through designated sales channels with #TRMPBF suffix.

ELECTRICAL CHARACTERISTICS

The ● denotes the specifications which apply over the full operating temperature range, otherwise specifications are at $T_A = 25^\circ\text{C}$. $\text{AGND} - V_{EE} = 54\text{V}$, $\text{AGND} = \text{DGND}$, and $V_{DD} - \text{DGND} = 3.3\text{V}$ unless otherwise noted. (Notes 3, 4)

SYMBOL	PARAMETER	CONDITIONS	MIN	TYP	MAX	UNITS	
V_{EE}	Main PoE Supply Voltage	$\text{AGND} - V_{EE}$	●	45	57	V	
		For IEEE Type 1 Compliant Output	●	51	57	V	
For IEEE Type 2 Compliant Output		●	54.75	57	V		
	Undervoltage Lockout	$\text{AGND} - V_{EE}$	●	20	25	30	V
V_{DD}	V_{DD} Supply Voltage	$V_{DD} - \text{DGND}$	●	3.0	3.3	4.3	V
	Undervoltage Lockout		●	2.2			V
	Allowable Digital Ground Offset	$\text{DGND} - V_{EE}$	●	25		57	V
I_{EE}	V_{EE} Supply Current	$(\text{AGND} - V_{EE}) = 55\text{V}$	●	-2.4	-5	mA	
I_{DD}	V_{DD} Supply Current	$(V_{DD} - \text{DGND}) = 3.3\text{V}$	●	1.1	3	mA	

Detection

	Detection Current – Force Current	First Point, $\text{AGND} - V_{OUTn} = 9\text{V}$	●	220	240	260	μA
		Second Point, $\text{AGND} - V_{OUTn} = 3.5\text{V}$	●	140	160	180	μA
	Detection Voltage – Force Voltage	$\text{AGND} - V_{OUTn}$, $5\mu\text{A} \leq I_{OUTn} \leq 500\mu\text{A}$	●	7	8	9	V
		First Point	●	3	4	5	V
	Second Point		●				
	Detection Current Compliance	$\text{AGND} - V_{OUTn} = 0\text{V}$	●		0.8	0.9	mA
V_{OC}	Detection Voltage Compliance	$\text{AGND} - V_{OUTn}$, Open Port	●		10.4	12	V
	Detection Voltage Slew Rate	$\text{AGND} - V_{OUTn}$, $C_{PORT} = 0.15\mu\text{F}$	●			0.01	V/ μs
	Minimum Valid Signature Resistance		●	15.5	17	18.5	k Ω
	Maximum Valid Signature Resistance		●	27.5	29.7	32	k Ω

Classification

V_{CLASS}	Classification Voltage	$\text{AGND} - V_{OUTn}$, $0\text{mA} \leq I_{CLASS} \leq 50\text{mA}$	●	16.0		20.5	V
	Classification Current Compliance	$V_{OUTn} = \text{AGND}$	●	53	61	67	mA
	Classification Threshold Current	Class 0 – 1	●	5.5	6.5	7.5	mA
		Class 1 – 2	●	13.5	14.5	15.5	mA
		Class 2 – 3	●	21.5	23	24.5	mA
		Class 3 – 4	●	31.5	33	34.9	mA
		Class 4 – Overcurrent	●	45.2	48	50.8	mA
V_{MARK}	Classification Mark State Voltage	$\text{AGND} - V_{OUTn}$, $0.1\text{mA} \leq I_{CLASS} \leq 10\text{mA}$	●	7.5	9	10	V
	Mark State Current Compliance	$V_{OUTn} = \text{AGND}$	●	53	61	67	mA

Gate Driver

	GATE Pin Pull-Down Current	Port Off, $V_{GATEn} = V_{EE} + 5\text{V}$	●	0.4			mA
		Port Off, $V_{GATEn} = V_{EE} + 1\text{V}$	●	0.08	0.12		mA
	GATE Pin Fast Pull-Down Current	$V_{GATEn} = V_{EE} + 5\text{V}$			30		mA
	GATE Pin On Voltage	$V_{GATEn} - V_{EE}$, $I_{GATEn} = 1\mu\text{A}$	●	8	12	14	V

Output Voltage Sense

V_{PG}	Power Good Threshold Voltage	$V_{OUTn} - V_{EE}$	●	2	2.4	2.8	V
	OUT Pin Pull-Up Resistance to AGND	$0\text{V} \leq (\text{AGND} - V_{OUTn}) \leq 5\text{V}$	●	300	500	700	k Ω

LTC4266A/LTC4266C

ELECTRICAL CHARACTERISTICS The ● denotes the specifications which apply over the full operating temperature range, otherwise specifications are at $T_A = 25^\circ\text{C}$. $AGND - V_{EE} = 54\text{V}$, $AGND = DGND$, and $V_{DD} - DGND = 3.3\text{V}$ unless otherwise noted. (Notes 3, 4)

SYMBOL	PARAMETER	CONDITIONS	MIN	TYP	MAX	UNITS	
Current Sense							
V_{CUT}	Overcurrent Sense Voltage	$V_{SENSEn} - V_{EE}$ $hpen = 0Fh, cutn[5:0] \geq 4$ (Note 12) $cutrng = 0$ $cutrng = 1$	● ●	9 4.5	9.38 4.69	9.75 4.88	mV/LSB mV/LSB
	Overcurrent Sense in AUTO Pin Mode	Class 0, Class 3 Class 1 Class 2 Class 4	● ● ● ●	90 26 49 152	94 28 52 159	98 30 55 166	mV mV mV mV
V_{LIM}	Active Current Limit in 802.3af Compliant Mode	$V_{SENSEn} - V_{EE}$, $hpen = 0Fh$, $limn = 80h$, $V_{EE} = 55\text{V}$ (Note 12) $V_{EE} < V_{OUT} < AGND - 29\text{V}$ $AGND - V_{OUT} = 0\text{V}$	●	102	106	110	mV
			●	20	50	50	mV
V_{LIM}	Active Current Limit in High Power Mode	$hpen = 0Fh$, $limn = C0h$, $V_{EE} = 55\text{V}$ $V_{OUT} - V_{EE} = 0\text{V}$ to 10V $V_{EE} + 23\text{V} < V_{OUT} < AGND - 29\text{V}$ $AGND - V_{OUT} = 0\text{V}$	●	204	212	221	mV
			●	100	106	113	mV
			●	20	50	50	mV
V_{LIM}	Active Current Limit in AUTO Pin Mode	$V_{OUT} - V_{EE} = 0\text{V}$ to 10V , $V_{EE} = 55\text{V}$ Class 0 to Class 3 Class 4	● ●	102 204	106 212	110 221	mV mV
V_{MIN}	DC Disconnect Sense Voltage	$V_{SENSEn} - V_{EE}$, $rdis = 0$ $V_{SENSEn} - V_{EE}$, $rdis = 1$	●	2.6	3.8	4.8	mV
			●	1.3	1.9	2.41	mV
V_{SC}	Short-Circuit Sense	$V_{SENSEn} - V_{EE} - V_{LIM}$, $rdis = 0$ $V_{SENSEn} - V_{EE} - V_{LIM}$, $rdis = 1$	●	160	200	255	mV
			●	75	100	135	mV
Port Current ReadBack							
	Resolution	No Missing Codes, $fast_iv = 0$		14		Bits	
	LSB Weight	$V_{SENSEn} - V_{EE}$		30.5		$\mu\text{V}/\text{LSB}$	
	50Hz to 60Hz Noise Rejection	(Note 7)		30		dB	
Port Voltage ReadBack							
	Resolution	No Missing Codes, $fast_iv = 0$		14		bits	
	LSB Weight	$AGND - V_{OUTn}$		5.835		mV/LSB	
	50Hz to 60Hz Noise Rejection	(Note 7)		30		dB	
Digital Interface							
V_{ILD}	Digital Input Low Voltage	ADn , $\overline{\text{RESET}}$, $\overline{\text{MSD}}$, $\overline{\text{SHDNn}}$, AUTO , MID (Note 6)	●			0.8	V
	I ² C Input Low Voltage	SCL , SDAIN (Note 6)	●			0.8	V
V_{IHD}	Digital Input High Voltage	(Note 6)	●	2.2			V
	Digital Output Low Voltage	$I_{SDAOUT} = 3\text{mA}$, $I_{INT} = 3\text{mA}$ $I_{SDAOUT} = 5\text{mA}$, $I_{INT} = 5\text{mA}$	●			0.4	V
			●			0.7	V
	Internal Pull-Up to V_{DD}	ADn , $\overline{\text{SHDNn}}$, $\overline{\text{RESET}}$, $\overline{\text{MSD}}$		50			$\text{k}\Omega$
	Internal Pull-Down to $DGND$	AUTO , MID		50			$\text{k}\Omega$

ELECTRICAL CHARACTERISTICS The ● denotes the specifications which apply over the full operating temperature range, otherwise specifications are at $T_A = 25^\circ\text{C}$. $\text{AGND} - V_{EE} = 54\text{V}$, $\text{AGND} = \text{DGND}$, and $V_{DD} - \text{DGND} = 3.3\text{V}$ unless otherwise noted. (Notes 3, 4)

SYMBOL	PARAMETER	CONDITIONS		MIN	TYP	MAX	UNITS
Timing Characteristics							
t_{DET}	Detection Time	Beginning to End of Detection (Note 7)	●	270	290	310	ms
t_{DETDLY}	Detection Delay	From PD Connected to Port to Detection Complete (Note 7)	●	300		470	ms
t_{CLE}	Class Event Duration	(Note 7)	●		12		ms
t_{CLEON}	Class Event Turn-On Duration	$C_{\text{PORT}} = 0.6\mu\text{F}$ (Note 7)	●			0.1	ms
t_{ME}	Mark Event Duration	(Notes 7, 11)	●		8.6		ms
t_{MEL}	Last Mark Event Duration	(Notes 7, 11)	●	16	22		ms
t_{PON}	Power On Delay in AUTO Pin Mode	From End of Valid Detect to Application of Power to Port (Note 7)	●			60	ms
	Turn On Rise Time	($\text{AGND} - V_{\text{OUT}}$): 10% to 90% of ($\text{AGND} - V_{EE}$), $C_{\text{PORT}} = 0.15\mu\text{F}$ (Note 7)	●	15	24		μs
	Turn On Ramp Rate	$C_{\text{PORT}} = 0.15\mu\text{F}$ (Note 7)	●			10	$\text{V}/\mu\text{s}$
	Fault Delay	From I_{CUT} Fault to Next Detect	●	1.0	1.1		s
	Midspan Mode Detection Backoff	$R_{\text{port}} = 15.5\text{k}\Omega$ (Note 7)	●	2.3	2.5	2.7	s
	Power Removal Detection Delay	From Power Removal After t_{DIS} to Next Detect (Note 7)	●	1.0	1.3	2.5	s
t_{START}	Maximum Current Limit Duration During Port Start-Up	(Note 7)	●	52	62.5	66	ms
t_{LIM}	Maximum Current Limit Duration After Port Start-Up	$t_{\text{LIM}} \text{ Enable} = 1$ (Notes 7, 12)	●		11.9		ms
t_{CUT}	Maximum Overcurrent Duration After Port Start-Up	(Note 7)	●	52	62.5	66	ms
	Maximum Overcurrent Duty Cycle	(Note 7)	●	5.8	6.3	6.7	%
t_{MPS}	Maintain Power Signature (MPS) Pulse Width Sensitivity	Current Pulse Width to Reset Disconnect Timer (Notes 7, 8)	●	1.6		3.6	ms
t_{DIS}	Maintain Power Signature (MPS) Dropout Time	(Note 7)	●	320	350	380	ms
t_{MSD}	Masked Shut Down Delay	(Note 7)	●			6.5	μs
t_{SHDN}	Port Shut Down Delay	(Note 7)	●			6.5	μs
	I ² C Watchdog Timer Duration		●	1.5	2	3	s
	Minimum Pulse Width for Masked Shut Down	(Note 7)	●	3			μs
	Minimum Pulse Width for SHDN	(Note 7)	●	3			μs
	Minimum Pulse Width for $\overline{\text{RESET}}$	(Note 7)	●	4.5			μs

LTC4266A/LTC4266C

ELECTRICAL CHARACTERISTICS The ● denotes the specifications which apply over the full operating temperature range, otherwise specifications are at $T_A = 25^\circ\text{C}$. $AGND - V_{EE} = 54\text{V}$, $AGND = DGND$, and $V_{DD} - DGND = 3.3\text{V}$ unless otherwise noted. (Notes 3, 4)

SYMBOL	PARAMETER	CONDITIONS	MIN	TYP	MAX	UNITS
I²C Timing						
	Clock Frequency	(Note 7)	●		1	MHz
t_1	Bus Free Time	Figure 5 (Notes 7, 9)	●	480		ns
t_2	Start Hold Time	Figure 5 (Notes 7, 9)	●	240		ns
t_3	SCL Low Time	Figure 5 (Notes 7, 9)	●	480		ns
t_4	SCL High Time	Figure 5 (Notes 7, 9)	●	240		ns
t_5	Data Hold Time	Figure 5 (Notes 7, 9) Data into Chip Data Out of Chip	● ●	60	120	ns ns
t_6	Data Set-Up Time	Figure 5 (Notes 7, 9)	●	80		ns
t_7	Start Set-Up Time	Figure 5 (Notes 7, 9)	●	240		ns
t_8	Stop Set-Up Time	Figure 5 (Notes 7, 9)	●	240		ns
t_r	SCL, SDAIN Rise Time	Figure 5 (Notes 7, 9)	●		120	ns
t_f	SCL, SDAIN Fall Time	Figure 5 (Notes 7, 9)	●		60	ns
	Fault Present to \overline{INT} Pin Low	(Notes 7, 9, 10)	●		150	ns
	Stop Condition to \overline{INT} Pin Low	(Notes 7, 9, 10)	●		1.5	μs
	ARA to \overline{INT} Pin High Time	(Notes 7, 9)	●		1.5	μs
	SCL Fall to ACK Low	(Notes 7, 9)	●		120	ns

Note 1: Stresses beyond those listed under Absolute Maximum Ratings may cause permanent damage to the device. Exposure to any Absolute Maximum Rating condition for extended periods may affect device reliability and lifetime.

Note 2: This IC includes overtemperature protection that is intended to protect the device during momentary overload conditions. Junction temperature will exceed 140°C when overtemperature protection is active. Continuous operation above the specified maximum operating junction temperature may impair device reliability.

Note 3: All currents into device pins are positive; all currents out of device pins are negative.

Note 4: The LTC4266A/LTC4266C operates with a negative supply voltage (with respect to ground). To avoid confusion, voltages in this data sheet are referred to in terms of absolute magnitude.

Note 5: t_{DJS} is the same as t_{MPDO} defined by IEEE 802.3at.

Note 6: The LTC4266A/LTC4266C digital interface operates with respect to DGND. All logic levels are measured with respect to DGND.

Note 7: Guaranteed by design, not subject to test.

Note 8: The IEEE 802.3af specification allows a PD to present its Maintain Power Signature (MPS) on an intermittent basis without being disconnected. In order to stay powered, the PD must present the MPS for t_{MPS} within any t_{MPDO} time window.

Note 9: Values measured at $V_{ILD(MAX)}$ and $V_{IHD(MIN)}$.

Note 10: If fault condition occurs during an I²C transaction, the \overline{INT} pin will not be pulled down until a stop condition is present on the I²C bus.

Note 11: Load Characteristic of the LTC4266A/LTC4266C during Mark:
 $7\text{V} < (AGND - V_{OUTn}) < 10\text{V}$ or $I_{OUT} < 50\mu\text{A}$

Note 12: See the LTC4266A/LTC4266C Software Programming documentation for information on serial bus usage and device configuration and status registers.

TYPICAL PERFORMANCE CHARACTERISTICS

Power-On Sequence in AUTO Pin Mode

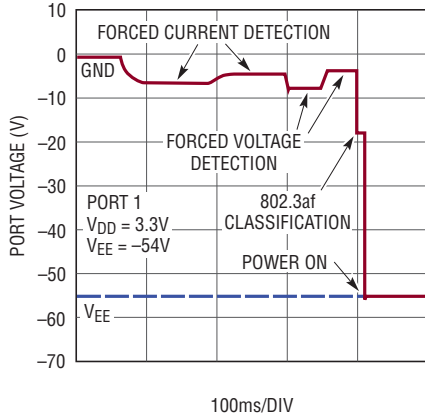

Powering Up into a 180µF Load

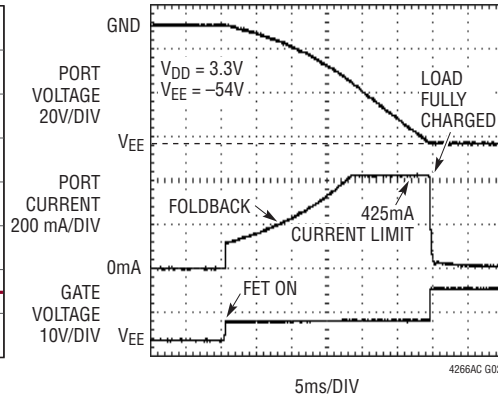

802.3af Classification in AUTO Pin Mode

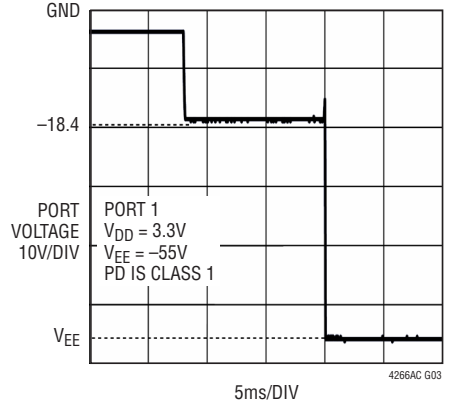

2-Event Classification in AUTO Pin Mode

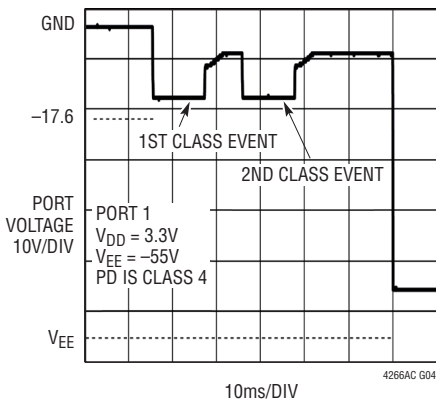

Classification Transient Response to 40mA Load Step

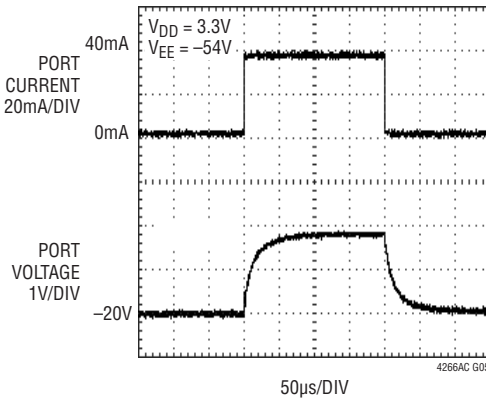

Classification Current Compliance

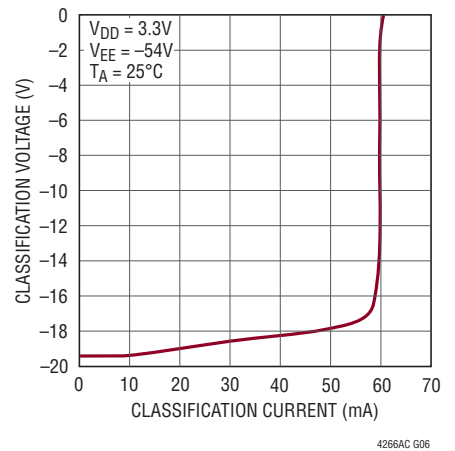

VDD Supply Current vs Voltage

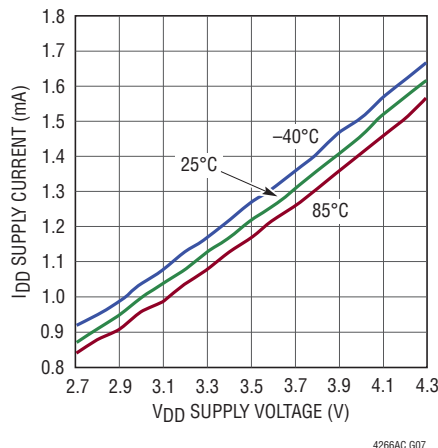

VEE Supply Current vs Voltage

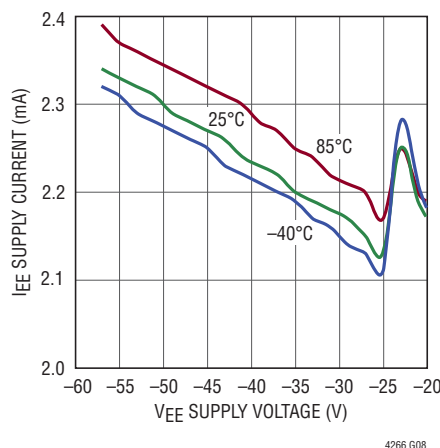

802.3at I_{LIM} Threshold vs Temperature

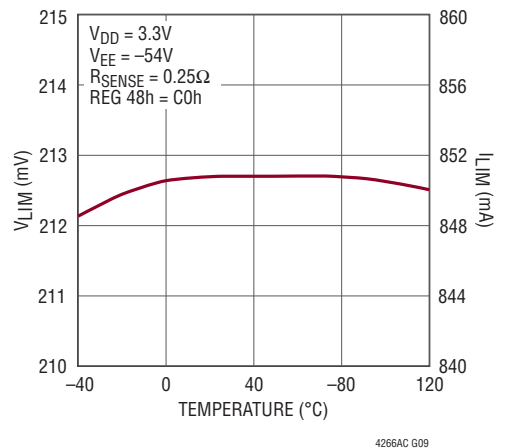

TYPICAL PERFORMANCE CHARACTERISTICS

802.3af I_{LIM} Threshold vs Temperature



802.3at I_{CUT} Threshold vs Temperature

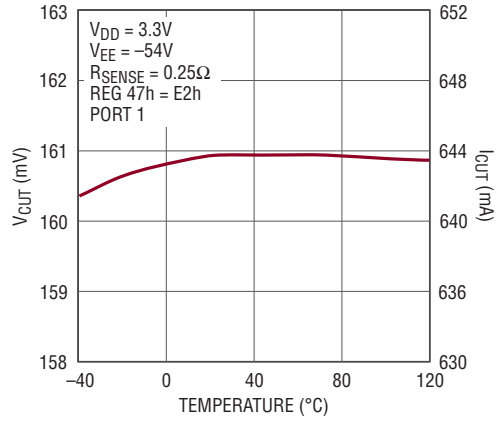

802.3af I_{CUT} Threshold vs Temperature



DC Disconnect Threshold vs Temperature

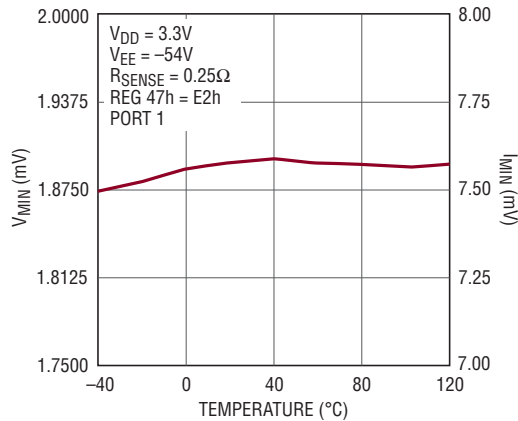

Current Limit Foldback

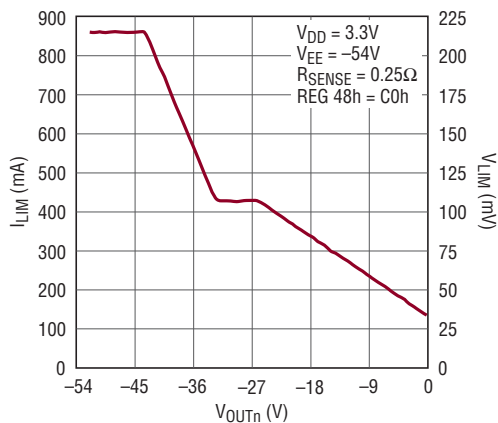

**ADC Noise Histogram
Current Readback in Fast Mode**

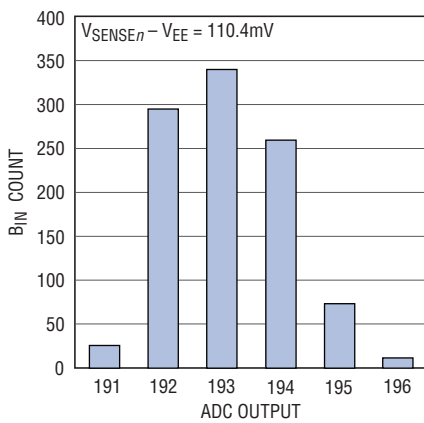

**ADC Integral Nonlinearity
Current Readback in Fast Mode**

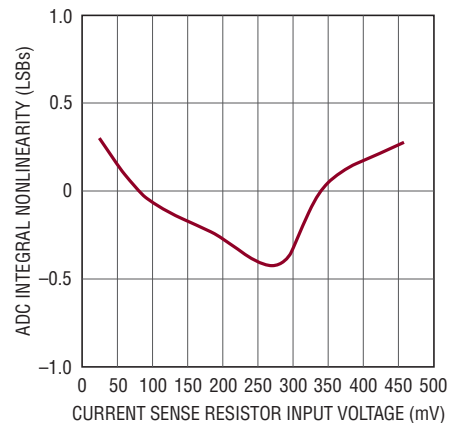

TYPICAL PERFORMANCE CHARACTERISTICS

ADC Noise Histogram
Current Readback in Slow Mode



ADC Integral Nonlinearity
Current Readback in Slow Mode

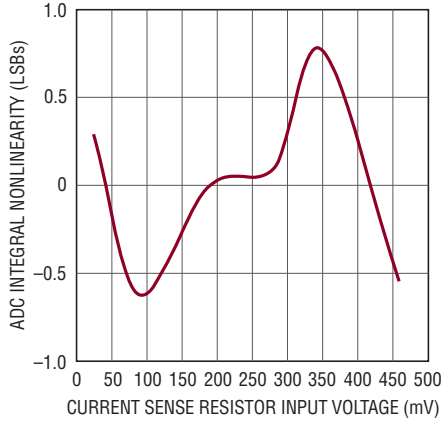

ADC Noise Histogram Port
Voltage Readback in Fast Mode

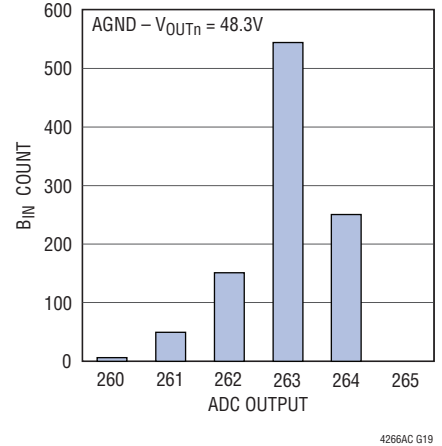

ADC Integral Nonlinearity
Voltage Readback in Fast Mode

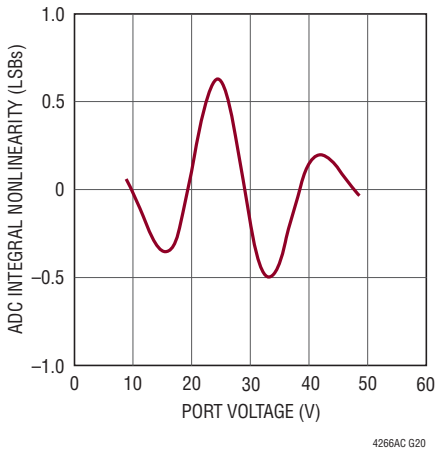

ADC Noise Histogram Port
Voltage Readback in Slow Mode

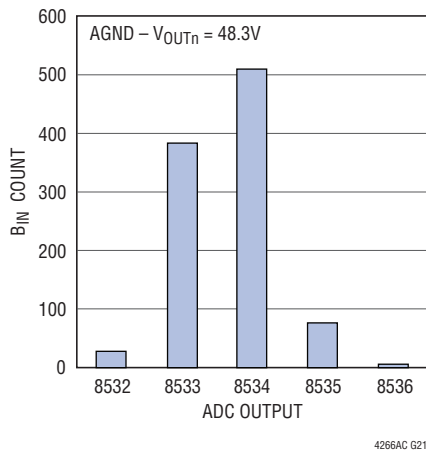

ADC Integral Nonlinearity
Voltage Readback in Slow Mode

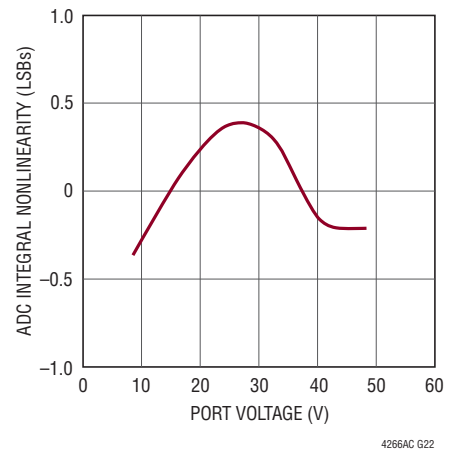

INT and SDAOUT Pull-Down
Voltage vs Load Current

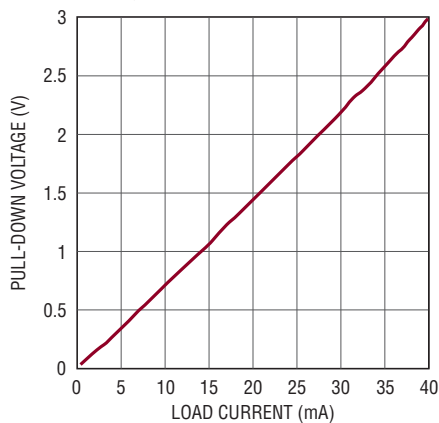

MOSFET Gate Drive with Fast
Pull-Down

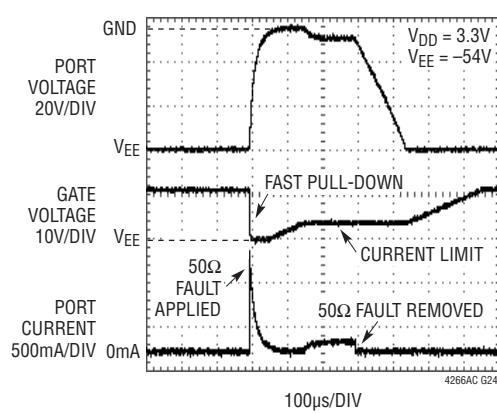

TEST TIMING DIAGRAMS

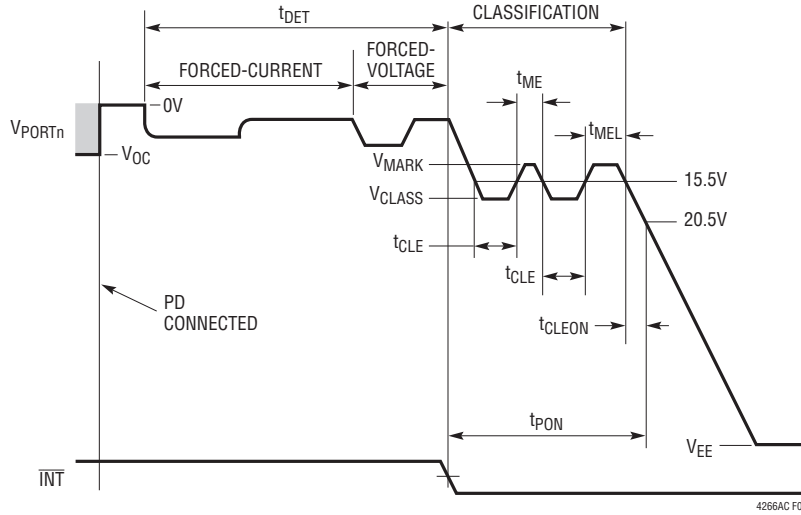

Figure 1. Detect, Class and Turn-On Timing in AUTO Pin or Semi-Auto Modes

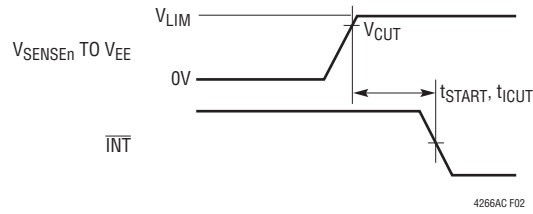

Figure 2. Current Limit Timing



Figure 3. DC Disconnect Timing

TEST TIMING DIAGRAMS



Figure 4. Shut Down Delay Timing



Figure 5. I²C Interface Timing

I²C TIMING DIAGRAMS



Figure 6. Writing to a Register



Figure 7. Reading from a Register

I²C TIMING DIAGRAMS



Figure 8. Reading the Interrupt Register (Short Form)

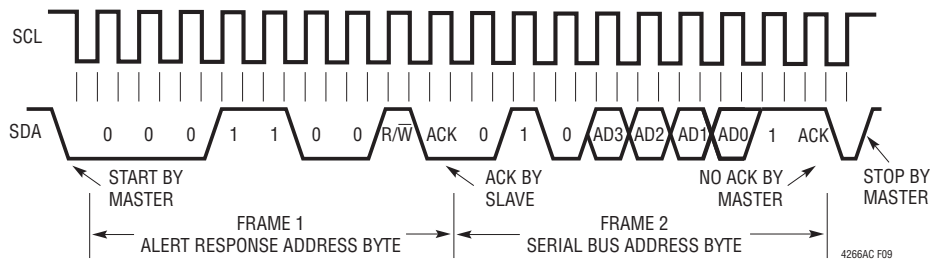

Figure 9. Reading from Alert Response Address

PIN FUNCTIONS

RESET: Chip Reset, Active Low. When the $\overline{\text{RESET}}$ pin is low, the LTC4266A/LTC4266C is held inactive with all ports off and all internal registers reset to their power-up states. When $\overline{\text{RESET}}$ is pulled high, the LTC4266A/LTC4266C begins normal operation. $\overline{\text{RESET}}$ can be connected to an external capacitor or RC network to provide a power turn-on delay. Internal filtering of the $\overline{\text{RESET}}$ pin prevents glitches less than 1 μs wide from resetting the LTC4266A/LTC4266C. Internally pulled up to V_{DD} .

MID: Midspan Mode Input. When high, the LTC4266A/LTC4266C acts as a midspan device. Internally pulled down to DGND.

INT: Interrupt Output, Open Drain. $\overline{\text{INT}}$ will pull low when any one of several events occur in the LTC4266A/LTC4266C. It will return to a high impedance state when bits 6 or 7 are set in the Reset PB register (1Ah). The $\overline{\text{INT}}$ signal can be used to generate an interrupt to the host processor, eliminating the need for continuous software polling. Individual $\overline{\text{INT}}$ events can be disabled using the Int Mask register (01h). See the LTC4266A/LTC4266C Software Programming documentation for more information. The $\overline{\text{INT}}$ pin is only updated between I²C transactions.

SCL: Serial Clock Input. High impedance clock input for the I²C serial interface bus. SCL must be tied high if not used.

SDAOUT: Serial Data Output, Open Drain Data Output for the I²C Serial Interface Bus. The LTC4266A/LTC4266C uses two pins to implement the bidirectional SDA function to simplify opto-isolation of the I²C bus. To implement a standard bidirectional SDA pin, tie SDAOUT and SDAIN together. SDAOUT should be grounded or left floating if not used. See the Applications Information section for more information.

SDAIN: Serial Data Input. High impedance data input for the I²C serial interface bus. The LTC4266A/LTC4266C uses two pins to implement the bidirectional SDA function to simplify opto-isolation of the I²C bus. To implement a standard bidirectional SDA pin, tie SDAOUT and SDAIN together. SDAIN must be tied high if not used. See the Applications Information section for more information.

AD3: Address Bit 3. Tie the address pins high or low to set the I²C serial address to which the LTC4266A/LTC4266C responds. This address will be 010A₃A₂A₁A₀b. Internally pulled up to V_{DD} .

AD2: Address Bit 2. See AD3.

AD1: Address Bit 1. See AD3.

AD0: Address Bit 0. See AD3.

NC, DNC: All pins identified with “NC” or “DNC” must be left unconnected.

DGND: Digital Ground. DGND is the return for the V_{DD} supply.

V_{DD}: Logic Power Supply. Connect to a 3.3V power supply relative to DGND. V_{DD} must be bypassed to DGND near the LTC4266A/LTC4266C with at least a 0.1 μF capacitor.

SHDN1: Shutdown Port 1, Active Low. When pulled low, $\overline{\text{SHDN1}}$ shuts down port 1, regardless of the state of the internal registers. Pulling $\overline{\text{SHDN1}}$ low is equivalent to setting the Reset Port 1 bit in the Reset Pushbutton register (1Ah). Internal filtering of the $\overline{\text{SHDN1}}$ pin prevents glitches less than 1 μs wide from resetting the port. Internally pulled up to V_{DD} .

SHDN2: Shutdown Port 2, Active Low. See $\overline{\text{SHDN1}}$.

SHDN3: Shutdown Port 3, Active Low. See $\overline{\text{SHDN1}}$.

SHDN4: Shutdown Port 4, Active Low. See $\overline{\text{SHDN1}}$.

AGND: Analog Ground. AGND is the return for the V_{EE} supply.

SENSE4: Port 4 Current Sense Input. SENSE4 monitors the external MOSFET current via a 0.5 Ω or 0.25 Ω sense resistor between SENSE4 and V_{EE} . Whenever the voltage across the sense resistor exceeds the overcurrent detection threshold V_{CUT} , the current limit fault timer counts up. If the voltage across the sense resistor reaches the current limit threshold V_{LIM} , the GATE4 pin voltage is lowered to maintain constant current in the external MOSFET. See the Applications Information section for further details. If the port is unused, the SENSE4 pin must be tied to V_{EE} .

PIN FUNCTIONS

GATE4: Port 4 Gate Drive. GATE4 should be connected to the gate of the external MOSFET for port 4. When the MOSFET is turned on, the gate voltage is driven to 12V (typ) above V_{EE} . During a current limit condition, the voltage at GATE4 will be reduced to maintain constant current through the external MOSFET. If the fault timer expires, GATE4 is pulled down, turning the MOSFET off and recording a t_{CUT} or t_{START} event. If the port is unused, float the GATE4 pin.

OUT4: Port 4 Output Voltage Monitor. OUT4 should be connected to the output port. A current limit foldback circuit limits the power dissipation in the external MOSFET by reducing the current limit threshold when the drain-to-source voltage exceeds 10V. The port 4 Power Good bit is set when the voltage from OUT4 to V_{EE} drops below 2.4V (typ). A 500k resistor is connected internally from OUT4 to AGND when the port is idle. If the port is unused, OUT4 pin must be floated.

SENSE3: Port 3 Current Sense Input. See SENSE4.

GATE3: Port 3 Gate Drive. See GATE4.

OUT3: Port 3 Output Voltage Monitor. See OUT4.

V_{EE} : Main Supply Input. Connect to a $-45V$ to $-57V$ supply, relative to AGND.

SENSE2: Port 2 Current Sense Input. See SENSE4.

GATE2: Port 2 Gate Drive. See GATE4.

OUT2: Port 2 Output Voltage Monitor. See OUT4.

SENSE1: Port 1 Current Sense Input. See SENSE4.

GATE1: Port 1 Gate Drive. See GATE 4.

OUT1: Port 1 Output Voltage Monitor. See OUT4.

AUTO: AUTO Pin Mode Input. AUTO pin mode allows the LTC4266A/LTC4266C to detect and power up a PD even if there is no host controller present on the I²C bus. The voltage of the AUTO pin determines the state of the internal registers when the LTC4266A/LTC4266C is reset or comes out of V_{DD} UVLO (see the LTC4266A/LTC4266C Software Programming documentation). The states of these register bits can subsequently be changed via the I²C interface. The real-time state of the AUTO pin is read at bit 0 in the Pin Status register (11h). Internally pulled down to DGND. Must be tied locally to either V_{DD} or DGND.

\overline{MSD} : Maskable Shutdown Input. Active low. When pulled low, all ports that have their corresponding mask bit set in the Misc Config register (17h) will be reset, equivalent to pulling the SHDN pin low. Internal filtering of the \overline{MSD} pin prevents glitches less than 1 μ s wide from resetting ports. Internally pulled up to V_{DD} .

OPERATION

Overview

Power over Ethernet, or PoE, is a standard protocol for sending DC power over copper Ethernet data wiring. The IEEE group that administers the 802.3 Ethernet data standards added PoE powering capability in 2003. This original PoE spec, known as 802.3af, allowed for 48V DC power at up to 13W. This initial spec was widely popular, but 13W was not adequate for some requirements. In 2009, the IEEE released a new standard, known as 802.3at or PoE+, increasing the voltage and current requirements to provide 25W of power.

The IEEE standard also defines PoE terminology. A device that provides power to the network is known as a PSE, or power sourcing equipment, while a device that draws power from the network is known as a PD, or powered device. PSEs come in two types: Endpoints (typically network switches or routers), which provide data and power; and Midspans, which provide power but pass through data. Midspans are typically used to add PoE capability to existing non-PoE networks. PDs are typically IP phones, wireless access points, security cameras, and similar devices.

PoE++ Evolution

Even during the process of creating the IEEE PoE+ 25.5W specification, it became clear that there was a significant and increasing need for more than 25.5W of delivered power. The LTC4266A family responds to this market by allowing a reliable means of providing up to 90W of delivered power to a LTPoE++ PD. The LTPoE++ specification provides reliable detection and classification extensions to the existing IEEE PoE technique that are backward compatible and interoperable with existing Type 1 and Type 2 PDs. Unlike other proprietary PoE++ solutions, Linear's LTPoE++ solution provides mutual identification between the PSE and PD. This ensures that the LTPoE++ PD knows it may use the requested power at start-up because it has detected a LTPoE++ PSE. LTPoE++ PSEs can differentiate between a LTPoE++ PD and all other types of IEEE compliant PDs allowing LTPoE++ PSEs to remain compliant and interoperable with existing equipment.

LTC4266 Product Family

The LTC4266 is a third-generation quad PSE controller that implements four PSE ports in either an end-point or midspan design. Virtually all necessary circuitry is included to implement an IEEE 802.3at compliant PSE design, requiring only an external power MOSFET and sense resistor per channel; these minimize power loss compared to alternative designs with on-board MOSFETs and increase system reliability in the event a single channel fails.

The LTC4266 comes in three grades which support different PD power levels.

The A-grade LTC4266 extends PoE power delivery capabilities to LTPoE++ levels. LTPoE++ is a Linear Technology proprietary specification allowing for the delivery of up to 90W to LTPoE++ compliant PDs. The LTPoE++ architecture extends the IEEE physical power negotiation to include 38.7W, 52.7W, 70W and 90W power levels. The A-grade LTC4266 also incorporates all B- and C-grade features.

The B-grade LTC4266 is a fully IEEE-compliant Type 2 PSE supporting autonomous detection, classification and powering of Type 1 and Type 2 PDs. The B-grade LTC4266 also incorporates all C-grade features. The B-grade LTC4266 is marketed and numbered without the B suffix for legacy reasons; the absence of power grade suffix infers a B-grade part.

The C-grade LTC4266 is a fully autonomous 802.3at Type 1 PSE solution. Intended for use only in AUTO pin mode, the C-grade chipset autonomously supports detection, classification and powering of Type 1 PDs. As a Type 1 PSE, 2-event classification is prohibited and Class 4 PDs are automatically treated as Class 0 PDs.

PoE Basics

Common Ethernet data connections consist of two or four twisted pairs of copper wire (commonly known as CAT-5 cable), transformer-coupled at each end to avoid ground loops. PoE systems take advantage of this coupling arrangement by applying voltage between the center-taps of the data transformers to transmit power from the PSE

OPERATION

- Fault protection current levels and timing are adjusted to reduce peak power in the MOSFET during a fault; this allows the new 25.5W power levels to be reached using the same MOSFETs as older 13W designs.

Extended Power LTPoE++

The LTC4266A adds the capability to autonomously deliver up to 90W of power to the PD. LTPoE++ PDs may forgo 802.3 LLDP support and rely solely on the LTPoE++ Physical Classification to negotiate power with LTPoE++ PSEs; this greatly simplifies high-power PD implementations.

LTPoE++ classification may be optionally enabled for the LTC4266A by setting both the High Power Enable and LTPoE++ Enable bits.

The higher levels of LTPoE++ delivery impose additional layout and component selection constraints. The LTC4266A is offered in 4 power levels (-1, -2, -3, and -4) which allows the AUTO pin mode LTC4266A to autonomously power up to supported power levels. If the AUTO pin is high, internal circuitry determines the maximum deliverable power. PDs requesting more than the available power limits are not powered.

Table 1. LTPoE++ Auto Pin Mode Maximum Delivered Power Capabilities

PART	PAIRS	PD POWER
LTC4266A-1	4	38.7W
LTC4266A-2	4	52.7W
LTC4266A-3	4	70W
LTC4266A-4	4	90W

APPLICATIONS INFORMATION

Operating Modes

The LTC4266A/LTC4266C include four independent ports, each of which can operate in one of four modes: manual, semi-auto, AUTO pin, or shutdown.

Table 2. Operating Modes

MODE	AUTO PIN	OPMD	DETECT/ CLASS	POWER-UP	AUTOMATIC I _{CUT} /I _{LIM} ASSIGNMENT
AUTO Pin	1	11b	Enabled at Reset	Automatically	Yes
Reserved	0	11b	N/A	N/A	N/A
Semi-auto	0	10b	Host Enabled	Upon Request	No
Manual	0	01b	Once Upon Request	Upon Request	No
Shutdown	0	00b	Disabled	Disabled	No

- In manual mode, the port waits for instructions from the host system before taking any action. It runs a single detection or classification cycle when commanded to by the host, and reports the result in its Port Status register. The host system can command the port to turn on or off the power at any time. This mode should only be used for diagnostic and test purposes.
- In semi-auto mode, the port repeatedly attempts to detect and classify any PD attached to it. It reports the status of these attempts back to the host, and waits for a command from the host before turning on power to the port. The host must enable detection (and optionally classification) for the port before detection will start.
- AUTO pin mode operates the same as semi-auto mode except that it will automatically turn on the power to the port if detection is successful. In AUTO pin mode, I_{CUT} and I_{LIM} values are set automatically by the LTC4266A/LTC4266C. This operational mode is only valid if the AUTO pin is high at reset or power-up and remains high during operation.
- In shutdown mode, the port is disabled and will not detect or power a PD.

Regardless of which mode it is in, the LTC4266A/LTC4266C will remove power automatically from any port that generates a current limit fault. It will also automatically remove power from any port that generates a disconnect event if disconnect detection is enabled. The host controller may also command the port to remove power at any time.

Reset and the AUTO/MID Pins

The initial LTC4266A/LTC4266C configuration depends on the state of the AUTO and MID pins during reset. Reset occurs at power-up, or whenever the $\overline{\text{RESET}}$ pin is pulled low or the global Reset All bit is set. Changing the state of AUTO or MID after power-up will not properly change the port behavior of the LTC4266A/LTC4266C until a reset occurs.

Although typically used with a host controller, the LTC4266A/LTC4266C can also be used in a standalone mode with no connection to the serial interface. If there is no host present, the AUTO pin must be tied high so that, at reset, all ports will be configured to operate automatically. Each port will detect and classify repeatedly until a PD is discovered, set I_{CUT} and I_{LIM} according to the classification results, apply power after successful detection, and remove power when a PD is disconnected.

Table 3 shows the I_{CUT} and I_{LIM} values that will be automatically set in standalone (AUTO pin) mode, based on the discovered class.

Table 3. I_{CUT} and I_{LIM} Values in Standalone AUTO Pin Mode

CLASS	I _{CUT}	I _{LIM}
Class 1	112mA	425mA
Class 2	206mA	425mA
Class 3 or Class 0	375mA	425mA
Class 4	638mA	850mA

The automatic setting of the I_{CUT} and I_{LIM} values only occurs if the LTC4266A/LTC4266C is reset with the AUTO pin high.

If the standalone application is a midspan, the MID pin must be tied high to enable correct midspan detection timing.

APPLICATIONS INFORMATION

DETECTION

Detection Overview

To avoid damaging network devices that were not designed to tolerate DC voltage, a PSE must determine whether the connected device is a real PD before applying power. The IEEE specification requires that a valid PD have a common-mode resistance of $25k \pm 5\%$ at any port voltage below 10V. The PSE must accept resistances that fall between 19k and 26.5k, and it must reject resistances above 33k or below 15k (shaded regions in Figure 11). The PSE may choose to accept or reject resistances in



Figure 11. IEEE 802.3af Signature Resistance Ranges

the undefined areas between the must-accept and must-reject ranges. In particular, the PSE must reject standard computer network ports, many of which have 150Ω common-mode termination resistors that will be damaged if power is applied to them (the black region at the left of Figure 11).

4-Point Detection

The LTC4266A/LTC4266C uses a 4-point detection method to discover PDs. False-positive detections are minimized by checking for signature resistance with both forced-current and forced-voltage measurements. Initially, two test currents are forced onto the port (via the OUTn pin) and the resulting voltages are measured. The detection

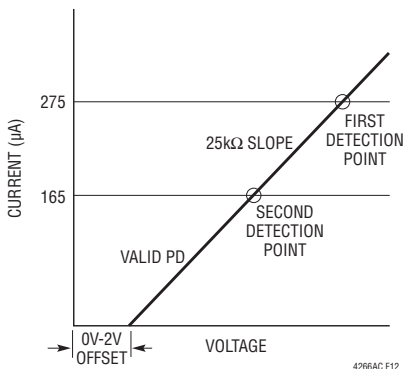

Figure 12. PD Detection

circuitry subtracts the two V-I points to determine the resistive slope while removing offset caused by series diodes or leakage at the port (see Figure 12). If the forced-current detection yields a valid signature resistance, two test voltages are then forced onto the port and the resulting currents are measured and subtracted. Both methods must report valid resistances for the port to report a valid detection. PD signature resistances between 17k and 29k (typically) are detected as valid and reported as Detect Good in the corresponding Port Status register. Values outside this range, including open and short-circuits, are also reported. If the port measures less than 1V at the first forced-current test, the detection cycle will abort and Short Circuit will be reported. Table 4 shows the possible detection results.

Table 4. Detection Status

MEASURED PD SIGNATURE	DETECTION RESULT
Incomplete or Not Yet Tested	Detect Status Unknown
<2.4k	Short Circuit
Capacitance > 2.7μF	C _{PD} Too High
2.4k < R _{PD} < 17k	R _{SIG} Too Low
17k < R _{PD} < 29k	Detect Good
>29k	R _{SIG} Too High
>50k	Open Circuit
Voltage > 10V	Port Voltage Outside Detect Range

More On Operating Modes

The port's operating mode determines when the LTC4266A/LTC4266C runs a detection cycle. In manual mode, the port will idle until the host orders a detect cycle. It will then run detection, report the results, and return to idle to wait for another command.

In semi-auto mode, the LTC4266A/LTC4266C autonomously polls a port for PDs, but it will not apply power until commanded to do so by the host. The Port Status register is updated at the end of each detection cycle. If a valid signature resistance is detected and classification is enabled, the port will classify the PD and report that result as well. The port will then wait for at least 100ms (or 2 seconds if midspan mode is enabled), and will repeat the detection cycle to ensure that the data in the Port Status register is up-to-date.

APPLICATIONS INFORMATION

If the port is in semi-auto mode and high power operation is enabled, the port will not turn on in response to a power-on command unless the current detect result is Detect Good. Any other detect result will generate a t_{START} fault if a power-on command is received. If the port is not in high power mode, it will ignore the detection result and apply power when commanded, maintaining backwards compatibility with the LTC4259A.

Behavior in AUTO pin mode is similar to semi-auto; however, after Detect Good is reported and the port is classified (if classification is enabled), it is automatically powered on without further intervention. In standalone (AUTO pin) mode, the I_{CUT} and I_{LIM} thresholds are automatically set; see the Reset and the AUTO/MID Pin section for more information.

The signature detection circuitry is disabled when the port is initially powered up with the AUTO pin low, in shutdown mode, or when the corresponding Detect Enable bit is cleared.

Detection of Legacy PDs

Proprietary PDs that predate the original IEEE 802.3af standard are commonly referred to today as legacy devices. One type of legacy PD uses a large common-mode capacitance ($>10\mu\text{F}$) as the detection signature. Note that PDs in this range of capacitance are defined as invalid, so a PSE that detects legacy PDs is technically noncompliant with the IEEE spec.

The LTC4266A/LTC4266C can be configured to detect this type of legacy PD. Legacy detection is disabled by default, but can be manually enabled on a per-port basis. When enabled, the port will report Detect Good when it sees either a valid IEEE PD or a high-capacitance legacy PD. With legacy mode disabled, only valid IEEE PDs will be recognized.

CLASSIFICATION

802.3af Classification

A PD can optionally present a classification signature to the PSE to indicate the maximum power it will draw while operating. The IEEE specification defines this signature as

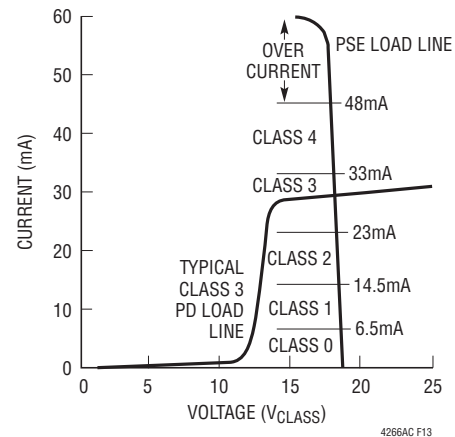

Figure 13. PD Classification

a constant current draw when the PSE port voltage is in the V_{CLASS} range (between 15.5V and 20.5V), with the current level indicating one of 5 possible PD classes. Figure 13 shows a typical PD load line, starting with the slope of the $25\text{k}\Omega$ signature resistor below 10V, then transitioning to the classification signature current (in this case, Class 3) in the V_{CLASS} range. Table 5 shows the possible classification values.

Table 5. Classification Values

CLASS	RESULT
Class 0	No Class Signature Present; Treat Like Class 3
Class 1	3W
Class 2	7W
Class 3	13W
Class 4	25.5W (Type 2)

If classification is enabled, the port will classify the PD immediately after a successful detection cycle in semi-auto or AUTO pin modes, or when commanded to in manual mode. It measures the PD classification signature by applying 18V for 12ms (both values typical) to the port via the OUT_n pin and measuring the resulting current; it then reports the discovered class in the Port Status register. If the LTC4266A/LTC4266C is in AUTO pin mode, it will additionally use the classification result to set the I_{CUT} and I_{LIM} thresholds. See the Reset and the AUTO/MID Pin section for more information.

The classification circuitry is disabled when the port is initially powered up with the AUTO pin low, in shutdown

APPLICATIONS INFORMATION

mode, or when the corresponding Class Enable bit is cleared.

802.3at 2-Event Classification

The 802.3at specification defines two methods of classifying a Type 2 PD. The LTC4266A supports 802.3at 2-event classification. The LTC4266C does not support 2-event classification.

One method adds extra fields to the Ethernet LLDP data protocol; although the LTC4266A/LTC4266C is compatible with this classification method, it cannot perform classification directly since it doesn't have access to the data path. LLDP classification requires the PSE to power the PD as a standard 802.3af (Type 1) device. It then waits for the host to perform LLDP communication with the PD and update the PSE port data. The LTC4266A/LTC4266C supports changing the I_{LIM} and I_{CUT} levels on the fly, allowing the host to complete LLDP classification.

The second 802.3at classification method, known as 2-event classification or ping-pong, is supported by the LTC4266A. A Type 2 PD that is requesting more than 13W will indicate Class 4 during normal 802.3af classification. If the LTC4266A sees Class 4, it forces the port to a specified lower voltage (called the mark voltage, typically 9V), pauses briefly, and then re-runs classification to verify the Class 4 reading (Figure 1). It also sets a bit in the High Power Status register to indicate that it ran the second classification cycle. The second cycle alerts the PD that it is connected to a Type 2 PSE which can supply Type 2 power levels.

2-event ping-pong classification is enabled by setting a bit in the port's High Power Mode register. Note that a ping-pong enabled port only runs the second classification cycle when it detects a Class 4 device; if the first cycle returns Class 0 to 3, the port assumes it is connected to a Type 1 PD and does not run the second classification cycle.

Invalid Type 2 Class Combinations

The 802.3at specification defines a Type 2 PD class signature as two consecutive Class 4 results; a Class 4 followed by a Class 0-3 is not a valid signature. In AUTO pin mode, the LTC4266A will power a detected PD regardless of the classification results, with one exception: if the PD

presents an invalid Type 2 signature (Class 4 followed by Class 0 to 3), the LTC4266A will not provide power and will restart the detection process. To aid in diagnosis, the Port Status register will always report the results of the last class pulse, so, for example, an invalid Class 4–Class 2 combination would report a second class pulse was run in the High Power Status register (which implies that the first cycle found Class 4), and Class 2 in the Port Status register.

POWER CONTROL

External MOSFET, Sense Resistor Summary

The primary function of the LTC4266A/LTC4266C is to control the delivery of power to the PSE port. It does this by controlling the gate drive voltage of an external power MOSFET while monitoring the current via an external sense resistor and the output voltage at the OUT pin. This circuitry serves to couple the raw V_{EE} input supply to the port in a controlled manner that satisfies the PD's power needs while minimizing power dissipation in the MOSFET and disturbances on the V_{EE} backplane.

The LTC4266A/LTC4266C is designed to use 0.25Ω sense resistors to minimize power dissipation. It also supports 0.5Ω sense resistors, which are the default when LTC4258/LTC4259A compatibility is desired.

Inrush Control

Once the command has been given to turn on a port, the LTC4266A/LTC4266C ramps up the GATE pin of that port's external MOSFET in a controlled manner. Under normal power-up circumstances, the MOSFET gate will rise until the port current reaches the inrush current limit level (typically 450mA), at which point the GATE pin will be servoed to maintain the specified I_{INRUSH} current. During this inrush period, a timer (t_{START}) runs. When output charging is complete, the port current will fall and the GATE pin will be allowed to continue rising to fully enhance the MOSFET and minimize its on-resistance. The final V_{GS} is nominally 12V. The inrush period is maintained until the t_{START} timer expires. At this time if the inrush current limit level is still exceeded the port will be turned back off and a t_{START} fault reported.

APPLICATIONS INFORMATION

Current Limit

Each LTC4266A/LTC4266C port includes two current limiting thresholds (I_{CUT} and I_{LIM}), each with a corresponding timer (t_{CUT} and t_{LIM}). Setting the I_{CUT} and I_{LIM} thresholds depends on several factors: the class of the PD, the voltage of the main supply (V_{EE}), the type of PSE (Type 1 or Type 2), the sense resistor (0.5Ω or 0.25Ω), the SOA of the MOSFET, and whether or not the system is required to implement class enforcement.

Per the IEEE specification, the LTC4266A/LTC4266C will allow the port current to exceed I_{CUT} for a limited period of time before removing power from the port, whereas it will actively control the MOSFET gate drive to keep the port current below I_{LIM} . The port does not take any action to limit the current when only the I_{CUT} threshold is exceeded, but does start the t_{CUT} timer. If the current drops below the I_{CUT} current threshold before its timer expires, the t_{CUT} timer counts back down, but at 1/16 the rate that it counts up. If the t_{CUT} timer reaches 60ms (typical) the port is turned off and the port t_{CUT} fault is set. This allows the current limit circuitry to tolerate intermittent overload signals with duty cycles below about 6%; longer duty cycle overloads will turn the port off.

The I_{LIM} current limiting circuit is always enabled and actively limiting port current. The t_{LIM} timer is enabled only when the programmable t_{LIMn} field is non-zero. This allows t_{LIM} to be set to a shorter value than t_{CUT} to provide more aggressive MOSFET protection and turn off a port before MOSFET damage can occur. The t_{LIM} timer starts when the I_{LIM} threshold is exceeded. When the t_{LIM} timer reaches 1.7ms (typ) times the programmable t_{LIMn} field the port is turned off and the port t_{LIM} fault is set. When the t_{LIMn} field is zero, t_{LIM} behaviors are tracked by the t_{CUT} timer, which counts up during both I_{LIM} and I_{CUT} events.

I_{CUT} is typically set to a lower value than I_{LIM} to allow the port to tolerate minor faults without current limiting.

Per the IEEE specification, the LTC4266A/LTC4266C will automatically set I_{LIM} to 425mA (shown in bold in Table 6) during inrush at port turn-on, and then switch to the programmed I_{LIM} setting once inrush has completed. To maintain IEEE compliance, I_{LIM} should be kept at

425mA for all Type 1 PDs, and 850mA if a Type 2 PD is detected. I_{LIM} is automatically reset to 425mA when a port turns off.

I_{LIM} Foldback

The LTC4266A/LTC4266C features a two-stage foldback circuit that reduces the port current if the port voltage falls below the normal operating voltage. This keeps MOSFET power dissipation at safe levels for typical 802.3af MOSFETs, even at extended 802.3at power levels. Current limit and foldback behavior are programmable on a per-port basis. Table 6 gives examples of recommended I_{LIM} register settings.

Table 6. Example Current Limit Settings

I_{LIM} (mA)	INTERNAL REGISTER SETTING (hex)	
	$R_{\text{SENSE}} = 0.5\Omega$	$R_{\text{SENSE}} = 0.25\Omega$
53	88	
106	08	88
159	89	
213	80	08
266	8A	
319	09	89
372	8B	
425	00	80
478	8E	
531	92	8A
584	CB	
638	10	90
744	D2	9A
850	40	C0
956	4A	CA
1063	50	D0
1169	5A	DA
1275	60	E0
1488	52	49
1700		40
1913		4A
2125		50
2338		5A
2550		60
2975		52

APPLICATIONS INFORMATION

The LTC4266A/LTC4266C will support current levels well beyond the maximum values in the 802.3at specification. The shaded areas in Table 6 indicate settings that may require a larger external MOSFET, additional heat sinking, or enabling t_{LIM} .

MOSFET Fault Detection

LTC4266A/LTC4266C PSE ports are designed to tolerate significant levels of abuse, but in extreme cases it is possible for the external MOSFET to be damaged. A failed MOSFET may short source to drain, which will make the port appear to be on when it should be off; this condition may also cause the sense resistor to fuse open, turning off the port but causing the LTC4266A/LTC4266C SENSE pin to rise to an abnormally high voltage. A failed MOSFET may also short from gate to drain, causing the LTC4266A/LTC4266C GATE pin to rise to an abnormally high voltage. The LTC4266A/LTC4266C OUT, SENSE and GATE pins are designed to tolerate up to 80V faults without damage.

If the LTC4266A/LTC4266C sees any of these conditions for more than 180 μ s, it disables all port functionality, reduces the gate drive pull-down current for the port and reports a FET Bad fault. This is typically a permanent fault, but the host can attempt to recover by resetting the port, or by resetting the entire chip if a port reset fails to clear the fault. If the MOSFET is in fact bad, the fault will quickly return, and the port will disable itself again. The remaining ports of the LTC4266A/LTC4266C are unaffected.

An open or missing MOSFET will not trigger a FET Bad fault, but will cause a t_{START} fault if the LTC4266A/LTC4266C attempts to turn on the port.

Voltage and Current Readback

The LTC4266A/LTC4266C measures the output voltage and current at each port with an internal A/D converter. Port data is only valid when the port power is on. The converter has two modes:

- Slow mode: 14 samples per second, 14.5 bits resolution
- Fast mode: 440 samples per second, 9.5 bits resolution

In fast mode, the least significant 5 bits of the lower byte are zeroes so that bit scaling is the same in both modes.

Disconnect

The LTC4266A/LTC4266C monitors the port to make sure that the PD continues to draw the minimum specified current. A disconnect timer counts up whenever port current is below 7.5mA (typ), indicating that the PD has been disconnected. If the t_{DIS} timer expires, the port will be turned off and the disconnect bit in the fault event register will be set. If the current returns before the t_{DIS} timer runs out, the timer resets and will start counting from the beginning if the undercurrent condition returns. As long as the PD exceeds the minimum current level more often than t_{DIS} , it will stay powered.

Although not recommended, the DC disconnect feature can be disabled by clearing the corresponding DC Disconnect Enable bits. Note that this defeats the protection mechanisms built into the IEEE spec, since a powered port will stay powered after the PD is removed. If the still-powered port is subsequently connected to a non-PoE data device, the device may be damaged.

The LTC4266A/LTC4266C does not include AC disconnect circuitry, but includes AC Disconnect Enable bits to maintain compatibility with the LTC4259A. If the AC Disconnect Enable bits are set, DC disconnect will be used.

Shutdown Pins

The LTC4266A/LTC4266C includes a hardware \overline{SHDN} pin for each port. When a \overline{SHDN} pin is pulled to DGND, the corresponding port will be shut off immediately. The port remains shut down until re-enabled via I²C or a device reset in AUTO pin mode.

Masked Shutdown

The LTC4266A/LTC4266C provides a low latency port shedding feature to quickly reduce the system load when required. By allowing a pre-determined set of ports to be turned off, the current on an overloaded main power supply can be reduced rapidly while keeping high priority devices powered. Each port can be configured to high or low priority; all low-priority ports will shut down within 6.5 μ s after the \overline{MSD} pin is pulled low. If multiple ports in a LTC4266A/LTC4266C device are shut down via \overline{MSD} , they are staggered by at least 0.55 μ s to help reduce voltage

APPLICATIONS INFORMATION

transients on the main supply. If a port is turned off via $\overline{\text{MSD}}$, the corresponding Detection and Classification Enable bits are cleared, so the port will remain off until the host explicitly re-enables detection.

SERIAL DIGITAL INTERFACE

Overview

The LTC4266A/LTC4266C communicates with the host using a standard SMBus/I²C 2-wire interface. The LTC4266A/LTC4266C is a slave-only device, and communicates with the host master using the standard SMBus protocols. Interrupts are signaled to the host via the $\overline{\text{INT}}$ pin. The Timing Diagrams (Figures 5 through 9) show typical communication waveforms and their timing relationships. More information about the SMBus data protocols can be found at www.smbus.org.

The LTC4266A/LTC4266C requires both the V_{DD} and V_{EE} supply rails to be present for the serial interface to function.

Bus Addressing

The LTC4266A/LTC4266C's primary serial bus address is 010xxxxb, with the lower four bits set by the AD3-AD0 pins; this allows up to 16 LTC4266A/LTC4266Cs on a single bus. All LTC4266A/LTC4266Cs also respond to the address 0110000b, allowing the host to write the same command (typically configuration commands) to multiple LTC4266A/LTC4266Cs in a single transaction. If the LTC4266A/LTC4266C is asserting the $\overline{\text{INT}}$ pin, it will also respond to the alert response address (0001100b) per the SMBus spec.

Interrupts and SMBAlert

Most LTC4266A/LTC4266C port events can be configured to trigger an interrupt, asserting the $\overline{\text{INT}}$ pin and alerting the host to the event. This removes the need for the host to poll the LTC4266A/LTC4266C, minimizing serial bus traffic and conserving host CPU cycles. Multiple LTC4266A/LTC4266Cs can share a common $\overline{\text{INT}}$ line, with the host using the SMBAlert protocol (ARA) to determine which LTC4266A/LTC4266C caused an interrupt.

Register Description

For information on serial bus usage and device configuration and status, refer to the LTC4266A/LTC4266C Software Programming documentation.

EXTERNAL COMPONENT SELECTION

Power Supplies and Bypassing

The LTC4266A/LTC4266C requires two supply voltages to operate. V_{DD} requires 3.3V (nominally) relative to DGND. V_{EE} requires a negative voltage of between -45V and -57V for Type 1 PSEs, -51V to -57V for Type 2 PSEs or -54.75V to -57V for LTPoE++ PSEs, relative to AGND. The relationship between the two grounds is not fixed; AGND can be referenced to any level from V_{DD} to DGND, although it should typically be tied to either V_{DD} or DGND.

V_{DD} provides power for most of the internal LTC4266A/LTC4266C circuitry, and draws a maximum of 3mA. A ceramic decoupling cap of at least $0.1\mu\text{F}$ should be placed from V_{DD} to DGND, as close as practical to each LTC4266A/LTC4266C chip.

Figure 14 shows a three component low dropout regulator for a negative supply to DGND generated from the negative V_{EE} supply. V_{DD} is tied to AGND and DGND is negative referenced to AGND. This regulator drives a single LTC4266A/LTC4266C device. In Figure 15, DGND is tied to AGND in this boost converter circuit for a positive V_{DD} supply of 3.3V above AGND. This circuit can drive multiple LTC4266A/LTC4266C devices and opto couplers.



Figure 14. Negative LDO to DGND

APPLICATIONS INFORMATION

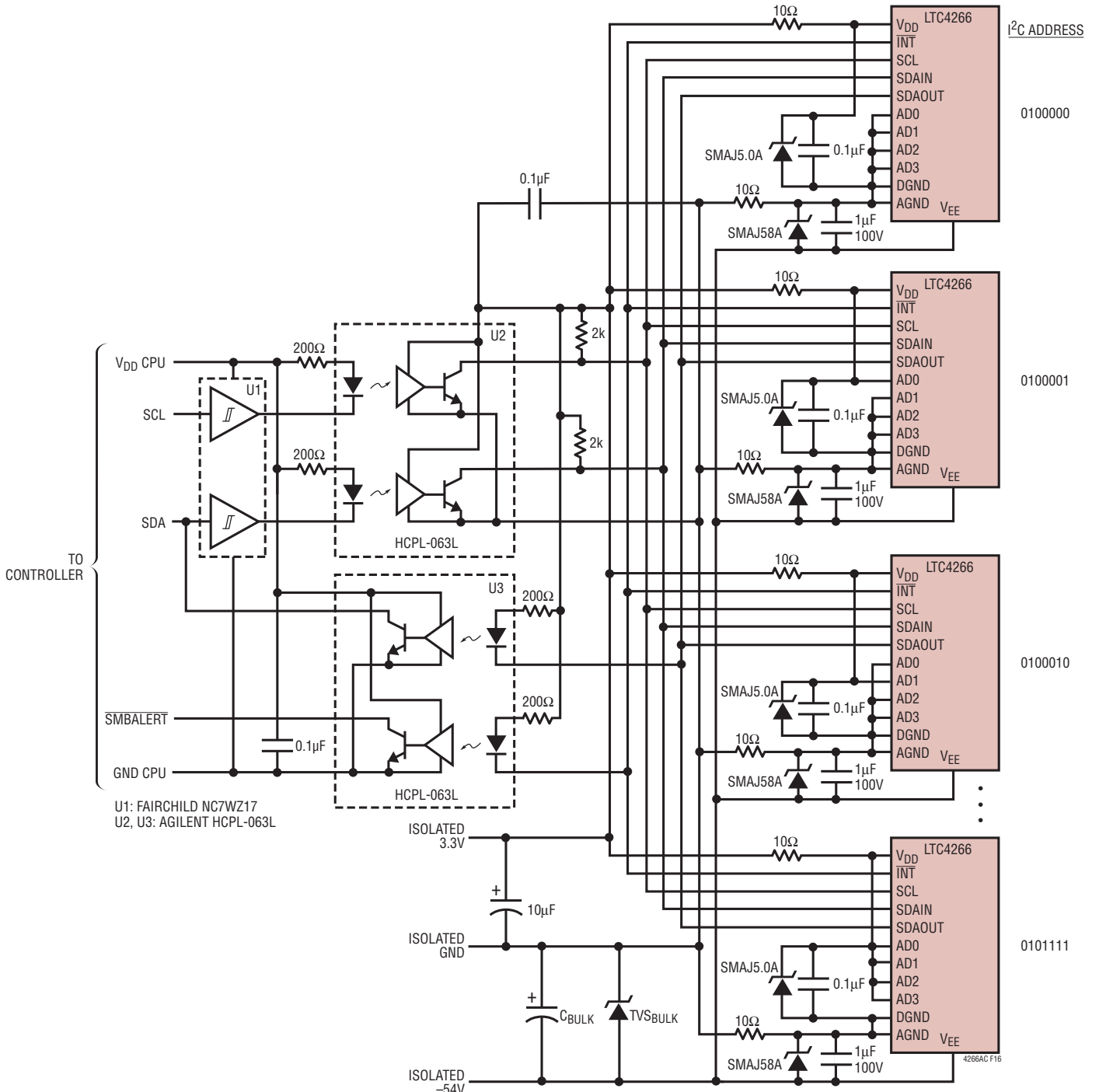

Figure 16. Opto-Isolating the I²C Bus

APPLICATIONS INFORMATION

If the V_{DD} supply is above AGND, each LTC4266A/LTC4266C requires a 10Ω , 0805 resistor (R2) in series from the +3.3V supply positive rail to the LTC4266A/LTC4266C V_{DD} pin. Across the LTC4266A/LTC4266C V_{DD} pin and DGND pin are an SMAJ5.0A, 5.0V TVS (D2) and a $0.1\mu\text{F}$ capacitor (C2). These components must be placed close to the LTC4266A/LTC4266C pins. DGND is tied directly to the protected AGND pin. Pull-ups at the logic pins should be to the protected side of the 10Ω resistors at the V_{DD} pin. Pull-downs at the logic pins should be to the protected side of the 10Ω resistors at the tied AGND and DGND pins.

Finally, each port requires a pair of S1B clamp diodes, one from OUT_n to supply AGND (D3) and one from OUT_n to supply V_{EE} (D4). The diodes at the ports steer harmful surges into the supply rails where they are absorbed by the surge suppressors and the V_{EE} bypass capacitance. The layout of these paths must be low impedance.

Further considerations include LTC4266A/LTC4266C applications with off-board connections, such as a daughter card to a mother board or headers to an external supply or host control board. Additional protection may be required at the LTC4266A/LTC4266C pins to these off-board connections.

LAYOUT GUIDELINES

Strict adherence to board layout, parts placement and routing guidelines is critical for optimal current reading accuracy, IEEE compliance, system robustness, and thermal dissipation.

Power delivery above 25.5W imposes additional component and layout restraints. Specifically MOSFET, sense resistor and transformer selection is crucial to safe and reliable system operation.

Contact LTC Applications to obtain a full set of layout guidelines, example layouts and BOMs.

PACKAGE DESCRIPTION

Please refer to <http://www.linear.com/product/LTC4266A#packaging> for the most recent package drawings.

UHF Package 38-Lead Plastic QFN (5mm × 7mm) (Reference LTC DWG # 05-08-1701 Rev C)

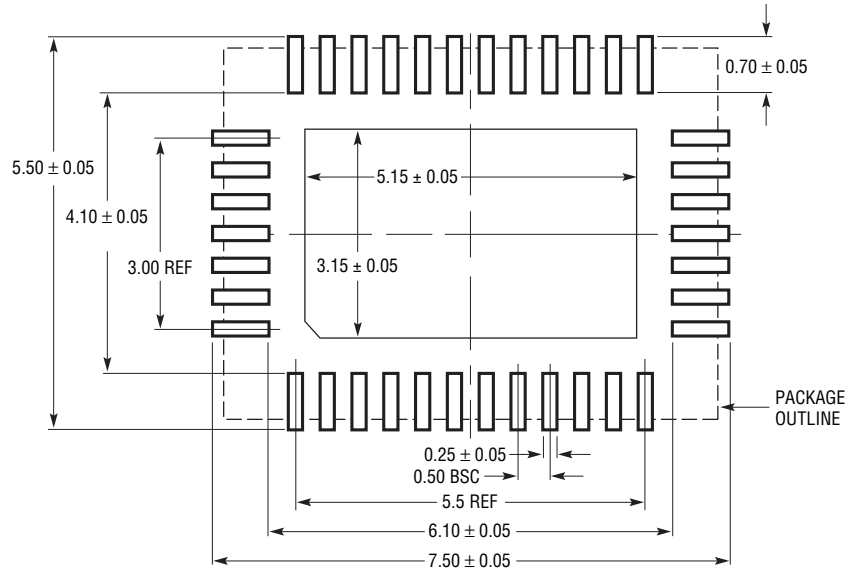

RECOMMENDED SOLDER PAD LAYOUT
APPLY SOLDER MASK TO AREAS THAT ARE NOT SOLDERED

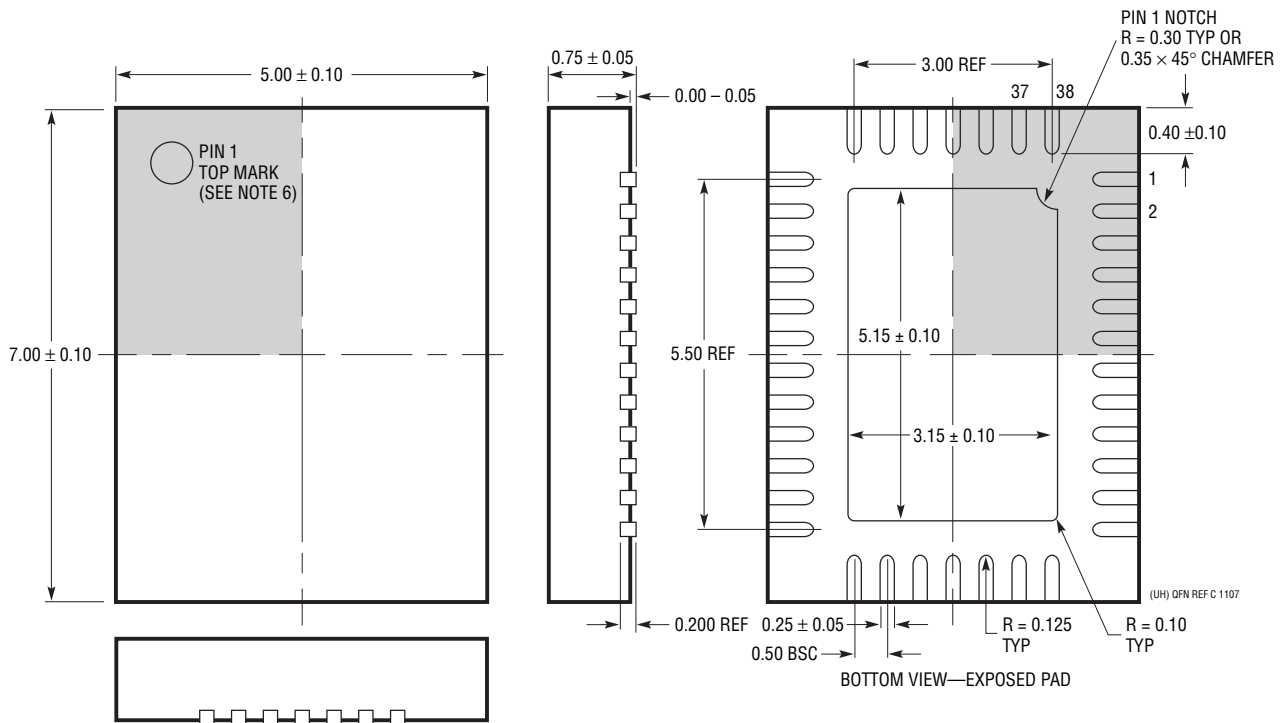

NOTE:

- DRAWING CONFORMS TO JEDEC PACKAGE OUTLINE MO-220 VARIATION WHKD
- DRAWING NOT TO SCALE
- ALL DIMENSIONS ARE IN MILLIMETERS
- DIMENSIONS OF EXPOSED PAD ON BOTTOM OF PACKAGE DO NOT INCLUDE MOLD FLASH. MOLD FLASH, IF PRESENT, SHALL NOT EXCEED 0.20mm ON ANY SIDE
- EXPOSED PAD SHALL BE SOLDER PLATED
- SHADED AREA IS ONLY A REFERENCE FOR PIN 1 LOCATION ON THE TOP AND BOTTOM OF PACKAGE

REVISION HISTORY

REV	DATE	DESCRIPTION	PAGE NUMBER
A	8/11	Changed Gate Typical voltage to 12V. Changed SCL, SDAIN V_{IL} to 1.0V (I^2C compliance). Table 4 (Class) reference and caption changed to Table 5. Power Supplies and Bypassing section changed to -45 for Type 1 minimum and -51 for Type 2 minimum. Related Parts Table CUT/LIM changed to I_{CUT}/I_{LIM} .	3, 14, 21 4 20 24 30
B	02/12	Change LTPoE++ power levels from 35W, 45W to 38.7W, 52.7W respectively Revised MAX value for V_{ILD} I^2C Input Low Voltage Clarified AUTO pin mode relationship to reset pin	1, 2, 15, 17 4 18
C	08/12	Table 1: Changed twisted pair requirement from 2-pair to 4-pair for 38.7W and 52.7W	17
D	06/15	Updated surge protection recommendations Simplified Power over Ethernet system diagram Added component value (Figure 15) Power level correction	1, 24, 26, 27, 30 16 25 1
E	07/17	Revised Figures 14 and 17.	25, 28

TYPICAL APPLICATION

One Complete 100base-t Isolated Powered Ethernet IEEE 802.3at Port



RELATED PARTS

PART NUMBER	DESCRIPTION	COMMENTS
LTC4270/LTC4271	12-Port PoE/PoE+/LTPoE++ PSE Controller	Transformer Isolation, Supports Type 1, Type 2 and LTPoE++ PDs
LTC4266	Quad IEEE 802.3at PoE PSE Controller	2-Event Classification, Programmable I _{CUT} /I _{LIM}
LTC4274	Single IEEE 802.3at PoE PSE Controller	2-Event Classification, Programmable I _{CUT} /I _{LIM}
LTC4274A/LTC4274C	Single IEEE 802.3at PoE PSE Controller	13W through 90W Support
LTC4265	IEEE 802.3at PD Interface Controller	100V, 1A Internal Switch, 2-Event Classification Recognition
LTC4267	IEEE 802.3af PD Interface with Integrated Switching Regulator	Internal 100V, 400mA Switch, Dual Inrush Current, Programmable Class
LTC4269-1	IEEE 802.3at PD Interface with Integrated Flyback Switching Regulator	2-Event Classification, Programmable Classification, Synchronous No-Opto Flyback Controller, 50kHz to 250kHz, Auxiliary Support
LTC4269-2	IEEE 802.3at PD Interface with Integrated Forward Switching Regulator	2-Event Classification, Programmable Classification, Synchronous Forward Controller, 100kHz to 500kHz, Auxiliary Support
LTC4278	IEEE 802.3at PD Interface with Integrated Flyback Switching Regulator	2-Event Classification, Programmable Classification, Synchronous No-Opto Flyback Controller, 50kHz to 250kHz, 12V Auxiliary Support

4266acfe

Mouser Electronics

Authorized Distributor

Click to View Pricing, Inventory, Delivery & Lifecycle Information:

[Analog Devices Inc.:](#)

[LTC4266AIUHF-2#TRPBF](#) [LTC4266AIUHF-1#PBF](#) [LTC4266AIUHF-4#PBF](#) [LTC4266AIUHF-4#TRPBF](#)
[LTC4266AIUHF-3#TRPBF](#) [LTC4266AIUHF-1#TRPBF](#) [LTC4266CIUHF#TRPBF](#) [LTC4266AIUHF-2#PBF](#)
[LTC4266AIUHF-3#PBF](#) [LTC4266CIUHF#PBF](#)