

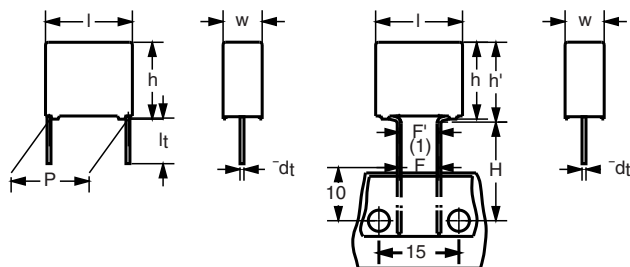

# AC and Pulse Double Metallized Polypropylene Film Capacitors MMKP Radial Potted Type



Dimensions in mm  
(1)  $|F - F'| < 0.3 \text{ mm}$   
 $F = 7.5 + 0.6/-0.1 \text{ mm}$

## FEATURES

7.5 mm bent back pitch. 15 mm to 27.5 mm lead pitch. Low contact resistance. Low loss dielectric. Small dimensions for high density packaging. Supplied loose in box and taped on reel

Material categorization: For definitions of compliance please see [www.vishay.com/doc?99912](http://www.vishay.com/doc?99912)



**RoHS**  
COMPLIANT

## ENCAPSULATION

Plastic case, epoxy resin sealed, flame retardant UL-class 94 V-0

## CLIMATIC CATEGORY

55/105/56

## CAPACITANCE RANGE (E24 SERIES)

0.001  $\mu\text{F}$  to 2.7  $\mu\text{F}$

## CAPACITANCE TOLERANCE

$\pm 5 \%$

## LEADS

Tinned wire

## RATED (DC) TEMPERATURE

85 °C

## RATED (AC) TEMPERATURE

105 °C

## MAXIMUM APPLICATION TEMPERATURE

105 °C

## DETAIL SPECIFICATION

For more detailed data and test requirements contact: [dc-film@vishay.com](mailto:dc-film@vishay.com)

## APPLICATIONS

Where steep pulses occur e.g. SMPS (switch mode power supplies). Electronic lighting e.g. Ballast. Motor control circuits. S-correction. For flyback applications please use 1400 V series.

## REFERENCE SPECIFICATIONS

IEC 60384-17

## MARKING

C-value; tolerance; rated voltage; sub-class; manufacturer's type; code for dielectric material; code for factory of origin; manufacturer; year and week of manufacture

## DIELECTRIC

Polypropylene film

## ELECTRODES

Metallized

## ENCAPSULATION

Flame retardant plastic case and epoxy resin

## CONSTRUCTION

Internal serial construction

## RATED (DC) VOLTAGE

250 V, 400 V, 630 V, 1000 V, 1400 V, 1600 V, 2000 V, 2500 V

## RATED (AC) VOLTAGE

125 V, 200 V, 220 V, 350 V, 500 V, 550 V, 700 V, 900 V

## RATED PEAK-TO-PEAK VOLTAGE

350 V, 560 V, 630 V, 1000 V, 1400 V, 1600 V, 2000 V, 2500 V

# MMKP383



Vishay BCcomponents AC and Pulse Double Metallized Polypropylene Film Capacitors MMKP Radial Potted Type

## COMPOSITION OF CATALOG NUMBER

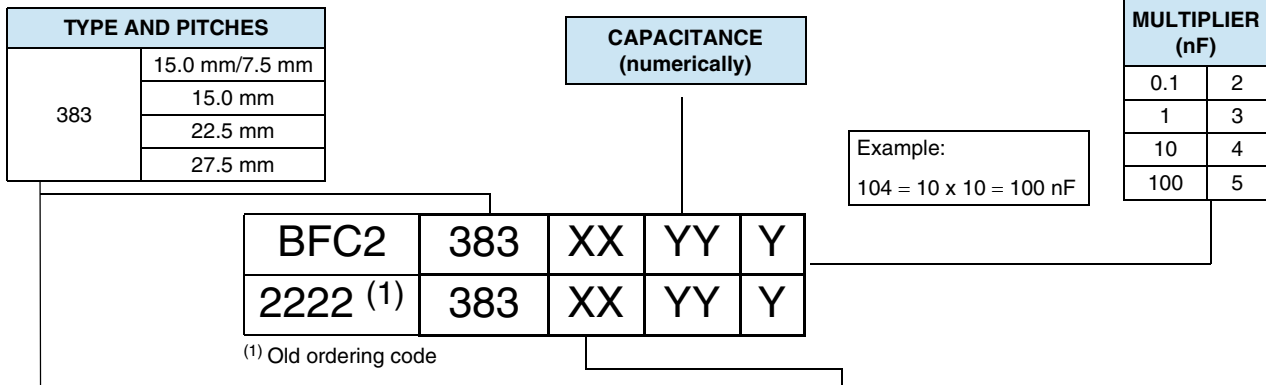

| TYPE | PACKAGING   | LEAD CONFIGURATION  | PREFERRED TYPES                                       |       |       |       |        |        |        |        |        |
|------|---|---|---|-------|-------|-------|--------|--------|--------|--------|--------|
|      |   |   | C-TOL.  | 250 V | 400 V | 630 V | 1000 V | 1400 V | 1600 V | 2000 V | 2500 V |
| 383  | Loose in box  | Lead length 3.5 mm ± 0.3 mm                                     | ± 5 %   | 00    | 10    | 20    | 30     | 40     | 50     | 60     | 70     |
|      | Taped on reel (bent back to 7.5 mm) <sup>(1)</sup>  | H = 16.0 mm; P <sub>0</sub> = 15.0 mm<br>reel diameter = 500 mm | ± 5 %   | 03    | 13    | 23    | 33     | 43     | 53     | 63     | -      |
|      |   |   | Dimensions of this code numbers stay between brackets |       |       |       |        |        |        |        |        |
|      |   |   | ON REQUEST  |       |       |       |        |        |        |        |        |
| 383  | Loose in box  | Lead length 5.0 mm ± 1.0 mm                                     | ± 5 %   | 01    | 11    | 21    | 31     | 41     | 51     | 61     | 71     |
|      |   | Lead length 25.0 mm ± 2.0 mm                                    | ± 5 %   | 04    | 14    | 24    | 34     | 44     | 54     | 64     | 74     |
|      | Taped on reel <sup>(1)</sup>                        | H = 18.5 mm; P <sub>0</sub> = 12.7 mm                           | ± 5 %   | 02    | 12    | 22    | 32     | 42     | 52     | 62     | 72     |
|      | Taped on reel (bent back to 7.5 mm) <sup>(1)</sup>  | H = 16.0 mm; P <sub>0</sub> = 15.0 mm<br>reel diameter = 356 mm | ± 5 %   | 05    | 15    | 25    | 35     | 45     | 55     | 65     | -      |
|      |   |   | Dimensions of this code numbers stay between brackets |       |       |       |        |        |        |        |        |
|      | Taped on reel (bent back to 10.0 mm) <sup>(1)</sup> | H = 16.0 mm; P <sub>0</sub> = 15.0 mm<br>reel diameter = 500 mm | ± 5 %   | 08    | 18    | 28    | 38     | 48     | 58     | 68     | -      |

**Note**

<sup>(1)</sup> For detailed tape specifications refer to "Packaging Information" [www.vishay.com/doc?28139](http://www.vishay.com/doc?28139) or end of catalog

## SPECIFIC REFERENCE DATA (250 Vdc)

| DESCRIPTION  | VALUE                   |                         |
|--|-------------------------|-------------------------|
|  | at 10 kHz               | at 100 kHz              |
| Tangent of loss angle:   |                         |                         |
| C ≤ 0.15 μF  | ≤ 5 x 10 <sup>-4</sup>  | ≤ 20 x 10 <sup>-4</sup> |
| 0.15 μF < C ≤ 0.39 μF  | ≤ 5 x 10 <sup>-4</sup>  | ≤ 25 x 10 <sup>-4</sup> |
| 0.39 μF < C ≤ 0.56 μF  | ≤ 10 x 10 <sup>-4</sup> | ≤ 25 x 10 <sup>-4</sup> |
| 0.56 μF < C ≤ 0.82 μF  | ≤ 10 x 10 <sup>-4</sup> | ≤ 40 x 10 <sup>-4</sup> |
| 0.82 μF < C ≤ 1.2 μF   | ≤ 10 x 10 <sup>-4</sup> | ≤ 50 x 10 <sup>-4</sup> |
| 1.2 μF < C ≤ 1.8 μF  | ≤ 10 x 10 <sup>-4</sup> | ≤ 65 x 10 <sup>-4</sup> |
| 1.8 μF < C ≤ 2.2 μF  | ≤ 15 x 10 <sup>-4</sup> | ≤ 75 x 10 <sup>-4</sup> |
| 2.2 μF < C ≤ 2.7 μF  | ≤ 15 x 10 <sup>-4</sup> | ≤ 85 x 10 <sup>-4</sup> |
| Rated voltage pulse slope (dU/d <sub>t</sub> )R:                     |                         |                         |
| C ≤ 0.15 μF  | 450 V/μs                |                         |
| 0.15 μF < C ≤ 0.39 μF  | 900 V/μs                |                         |
| 0.39 μF < C ≤ 0.82 μF  | 290 V/μs                |                         |
| 0.82 μF < C ≤ 2 μF   | 190 V/μs                |                         |
| 2 μF < C ≤ 2.7 μF  | 130 V/μs                |                         |
| R between leads, for C ≤ 1 μF at 100 V, 1 min                        | > 100 000 MΩ            |                         |
| RC between leads, for C > 1 μF at 100 V, 1 min                       | > 100 000 s             |                         |
| R between leads and case, 100 V, 1 min                               | > 30 000 MΩ             |                         |
| Ionization (AC) voltage (typical value) at 50 pC peak discharge      | > 220 V                 |                         |
| Withstanding (DC) voltage (cut off current 10 mA), rise time 100 V/s | 400 V, 1 min            |                         |
| Withstanding (DC) voltage between leads and case                     | 2840 V, 1 min           |                         |
| Maximum application temperature                                      | 105 °C                  |                         |



AC and Pulse Double Metallized Polypropylene  
Film Capacitors MMKP Radial Potted Type

Vishay BCcomponents

$U_{Rdc} = 250\text{ V}$ ;  $U_{Rac} = 125\text{ V}$ ;  $U_{pp} = 350\text{ V}$ ;  $C\text{-tol.} = \pm 5\%$

| C<br>( $\mu\text{F}$ )  | DIMENSIONS<br>w x h (h') x l<br>(mm) | MASS<br>(g) <sup>(1)</sup> | CATALOG NUMBER BFC2 383 XXYYY AND PACKAGING |                            |                 |                            |                | C-VALUE<br><br>..YYY     |
|---|--------------------------------------|----------------------------|---|----------------------------|-----------------|----------------------------|----------------|--------------------------|
|   |                                      |                            | LOOSE IN BOX                                |                            | Original pitch  | REEL                       |                |                          |
|   |                                      |                            | Leads<br>3.5 $\pm$ 0.3 mm                   | Leads<br>25.0 $\pm$ 2.0 mm |                 | Pitch = 7.5 mm (bent back) |                |                          |
|   |                                      |                            | XX<br>(SPQ)                                 | XX<br>(SPQ)                | XX<br>(SPQ)     | XX<br>(SPQ)                | XX<br>(SPQ)    |                          |
| Pitch = 15 mm $\pm$ 0.4 mm; $d_t = 0.80\text{ mm} \pm 0.08\text{ mm}$ |                                      |                            |   |                            | Pitch = 15 mm   | Pitch = 7.5 mm (bent back) |                |                          |
| 0.082<br>0.091<br>0.1   | 5.0 x 11.0 (13.0) x 17.5             | 1.1                        | 00...<br>(1250)                             | 04...<br>(1000)            | 02...<br>(1100) | 03...<br>(950)             | 05...<br>(550) | 823<br>913<br>104        |
| 0.11<br>0.12<br>0.13<br>0.15  | 6.0 x 12.0 (14.0) x 17.5             | 1.4                        | 00...<br>(1000)                             | 04...<br>(1000)            | 02...<br>(900)  | 03...<br>(800)             | 05...<br>(450) | 114<br>124<br>134<br>154 |
| 0.16<br>0.18<br>0.2   | 7.0 x 13.5 (15.5) x 17.5             | 1.8                        | 00...<br>(750)                              | 04...<br>(500)             | 02...<br>(800)  | 03...<br>(700)             | 05...<br>(400) | 164<br>184<br>204        |
| 0.22<br>0.24<br>0.27<br>0.3   | 8.5 x 15.0 (17.0) x 17.5             | 2.6                        | 00...<br>(750)                              | 04...<br>(500)             | 02...<br>(650)  | 03...<br>(550)             | 05...<br>(300) | 224<br>244<br>274<br>304 |
| 0.33<br>0.36<br>0.39  | 10.0 x 16.5 (18.5) x 17.5            | 3.3                        | 00...<br>(500)                              | 04...<br>(450)             | 02...<br>(600)  | 03...<br>(500)             | 05...<br>(250) | 334<br>364<br>394        |

**Notes**

<sup>(1)</sup> Net weight for short lead products only

• SPQ = Standard Packaging Quantity

$U_{Rdc} = 250\text{ V}$ ;  $U_{Rac} = 125\text{ V}$ ;  $U_{pp} = 350\text{ V}$ ;  $C\text{-tol.} = \pm 5\%$

| C<br>( $\mu\text{F}$ )  | DIMENSIONS<br>w x h x l<br>(mm) | MASS<br>(g) <sup>(1)</sup> | CATALOG NUMBER BFC2 383 XXYYY AND PACKAGING |                            |                 |                          | C-VALUE<br><br>..YYY |
|---|---------------------------------|----------------------------|---|----------------------------|-----------------|--------------------------|----------------------|
|   |                                 |                            | LOOSE IN BOX                                |                            | Original pitch  | REEL                     |                      |
|   |                                 |                            | Leads<br>3.5 $\pm$ 0.3 mm                   | Leads<br>25.0 $\pm$ 2.0 mm |                 |                          |                      |
|   |                                 |                            | XX<br>(SPQ)                                 | XX<br>(SPQ)                | XX<br>(SPQ)     |                          |                      |
| Pitch = 22.5 mm $\pm$ 0.4 mm; $d_t = 0.80\text{ mm} \pm 0.08\text{ mm}$ |                                 |                            |   |                            | Pitch = 22.5 mm |                          |                      |
| 0.43  | 7.0 x 116.5 x 26.0              | 3.0                        | 00...<br>(200)                              | 04...<br>(250)             | 02...<br>(550)  | 434                      |                      |
| 0.47<br>0.51<br>0.56<br>0.62  | 8.5 x 18.0 x 26.0               | 4.2                        | 00...<br>(200)                              | 04...<br>(250)             | 02...<br>(450)  | 474<br>514<br>564<br>624 |                      |
| 0.68<br>0.75<br>0.82  | 10.0 x 19.5 x 26.0              | 5.3                        | 00...<br>(200)                              | 04...<br>(200)             | 02...<br>(350)  | 684<br>754<br>824        |                      |
| Pitch = 27.5 mm $\pm$ 0.4 mm; $d_t = 0.80\text{ mm} \pm 0.08\text{ mm}$ |                                 |                            |   |                            | Pitch = 27.5 mm |                          |                      |
| 0.91<br>1.0<br>1.1<br>1.2   | 11.0 x 21.0 x 31.0              | 8.0                        | 00...<br>(750)                              | 04...<br>(125)             | -               | 914<br>105<br>115<br>125 |                      |
| 1.3<br>1.5<br>1.6   | 13.0 x 23.0 x 31.0              | 9.7                        | 00...<br>(500)                              | 04...<br>(125)             |                 | 135<br>155<br>165        |                      |
| 1.8<br>2.0  | 15.0 x 25.0 x 31.0              | 12.6                       | 00...<br>(100)                              | 04...<br>(125)             |                 | 185<br>205               |                      |
| 2.2<br>2.4<br>2.7   | 18.0 x 28.0 x 31.0              | 16.3                       | 00...<br>(100)                              | 04...<br>(100)             |                 | 225<br>245<br>275        |                      |

**Notes**

<sup>(1)</sup> Net weight for short lead products only

• SPQ = Standard Packaging Quantity

# MMKP383



Vishay BCcomponents AC and Pulse Double Metallized Polypropylene Film Capacitors MMKP Radial Potted Type

## SPECIFIC REFERENCE DATA (400 Vdc)

| DESCRIPTION  | VALUE                    |                          |
|--|--------------------------|--------------------------|
|  | at 10 kHz                | at 100 kHz               |
| Tangent of loss angle:   |                          |                          |
| $C \leq 0.22 \mu\text{F}$  | $\leq 5 \times 10^{-4}$  | $\leq 20 \times 10^{-4}$ |
| $0.22 \mu\text{F} < C \leq 0.33 \mu\text{F}$                         | $\leq 10 \times 10^{-4}$ | $\leq 35 \times 10^{-4}$ |
| $0.33 \mu\text{F} < C \leq 0.43 \mu\text{F}$                         | $\leq 10 \times 10^{-4}$ | $\leq 40 \times 10^{-4}$ |
| $0.43 \mu\text{F} < C \leq 0.68 \mu\text{F}$                         | $\leq 10 \times 10^{-4}$ | $\leq 50 \times 10^{-4}$ |
| $0.68 \mu\text{F} < C \leq 0.82 \mu\text{F}$                         | $\leq 10 \times 10^{-4}$ | $\leq 55 \times 10^{-4}$ |
| $0.82 \mu\text{F} < C \leq 1.2 \mu\text{F}$                          | $\leq 10 \times 10^{-4}$ | $\leq 60 \times 10^{-4}$ |
| $1.2 \mu\text{F} < C \leq 1.5 \mu\text{F}$                           | $\leq 10 \times 10^{-4}$ | $\leq 65 \times 10^{-4}$ |
| Rated voltage pulse slope (dU/dt) <sub>R</sub> :                     |                          |                          |
| $C \leq 0.082 \mu\text{F}$   | 600 V/ $\mu\text{s}$     |                          |
| $0.082 \mu\text{F} < C \leq 0.22 \mu\text{F}$                        | 1200 V/ $\mu\text{s}$    |                          |
| $0.22 \mu\text{F} < C \leq 0.43 \mu\text{F}$                         | 410 V/ $\mu\text{s}$     |                          |
| $0.42 \mu\text{F} < C \leq 1.1 \mu\text{F}$                          | 260 V/ $\mu\text{s}$     |                          |
| $1.1 \mu\text{F} < C \leq 1.5 \mu\text{F}$                           | 180 V/ $\mu\text{s}$     |                          |
| R between leads, for $C \leq 1 \mu\text{F}$ at 100 V, 1 min          | > 100 000 M $\Omega$     |                          |
| RC between leads, for $C > 1 \mu\text{F}$ at 100 V, 1 min            | > 100 000 s              |                          |
| R between leads and case, 100 V, 1 min                               | > 30 000 M $\Omega$      |                          |
| Ionization (AC) voltage (typical value) at 50 pC peak discharge      | > 220 V                  |                          |
| Withstanding (DC) voltage (cut off current 10 mA), rise time 100 V/s | 560 V, 1 min             |                          |
| Withstanding (DC) voltage between leads and case                     | 2840 V, 1 min            |                          |
| Maximum application temperature                                      | 105 °C                   |                          |

$U_{Rdc} = 400 \text{ V}$ ;  $U_{Rac} = 200 \text{ V}$ ;  $U_{pp} = 560 \text{ V}$ ; C-tol. =  $\pm 5 \%$

| C<br>( $\mu\text{F}$ )   | DIMENSIONS<br>w x h (h') x l<br>(mm) | MASS<br>(g) <sup>(1)</sup> | CATALOG NUMBER BFC2 383 XXYYY AND PACKAGING |                            |                |                            |             | C-VALUE<br><br>..YYY |
|--|--------------------------------------|----------------------------|---|----------------------------|----------------|----------------------------|-------------|----------------------|
|  |                                      |                            | LOOSE IN BOX                                |                            | Original pitch | REEL                       |             |                      |
|  |                                      |                            | Leads<br>3.5 $\pm$ 0.3 mm                   | Leads<br>25.0 $\pm$ 2.0 mm |                | Pitch = 7.5 mm (bent back) |             |                      |
|  |                                      |                            | XX<br>(SPQ)                                 | XX<br>(SPQ)                | XX<br>(SPQ)    | XX<br>(SPQ)                | XX<br>(SPQ) |                      |
| Pitch = 15 mm $\pm$ 0.4 mm; d <sub>t</sub> = 0.80 mm $\pm$ 0.08 mm |                                      |                            |   |                            | Pitch = 15 mm  | Pitch = 7.5 mm (bent back) |             |                      |
| 0.047  | 5.0 x 11.0 (13.0) x 17.5             | 1.1                        | 10...                                       | 14...                      | 12...          | 13...                      | 15...       | 473                  |
| 0.051  |                                      |                            | (1250)                                      | (1000)                     | (1100)         | (950)                      | (550)       | 513                  |
| 0.056  |                                      |                            |   |                            |                |                            |             | 563                  |
| 0.062  | 6.0 x 12.0 (14.0) x 17.5             | 1.4                        | 10...                                       | 14...                      | 12...          | 13...                      | 15...       | 623                  |
| 0.068  |                                      |                            | (1000)                                      | (1000)                     | (900)          | (800)                      | (450)       | 683                  |
| 0.075  |                                      |                            |   |                            |                |                            |             | 753                  |
| 0.082  |                                      |                            |   |                            |                |                            |             | 823                  |
| 0.091  | 7.0 x 13.5 (15.5) x 17.5             | 1.8                        | 10...                                       | 14...                      | 12...          | 13...                      | 15...       | 913                  |
| 0.1  |                                      |                            | (750)                                       | (500)                      | (800)          | (700)                      | (400)       | 104                  |
| 0.11   |                                      |                            |   |                            |                |                            |             | 114                  |
| 0.12   | 8.5 x 15.0 (17.0) x 17.5             | 2.5                        | 10...                                       | 14...                      | 12...          | 13...                      | 15...       | 124                  |
| 0.13   |                                      |                            | (750)                                       | (500)                      | (650)          | (550)                      | (300)       | 134                  |
| 0.15   |                                      |                            |   |                            |                |                            |             | 154                  |
| 0.16   |                                      |                            |   |                            |                |                            |             | 164                  |
| 0.18   | 10.0 x 16.5 (18.5) x 17.5            | 3.3                        | 10...                                       | 14...                      | 12...          | 13...                      | 15...       | 184                  |
| 0.2  |                                      |                            | (500)                                       | (450)                      | (600)          | (500)                      | (250)       | 204                  |
| 0.22   |                                      |                            |   |                            |                |                            |             | 224                  |

### Notes

- <sup>(1)</sup> Net weight for short lead products only
- SPQ = Standard Packaging Quantity



AC and Pulse Double Metallized Polypropylene  
Film Capacitors MMKP Radial Potted Type

Vishay BCcomponents

$U_{Rdc} = 400\text{ V}$ ;  $U_{Rac} = 200$  ;  $U_{p-p} = 560\text{ V}$ ; C-tol. =  $\pm 5\%$

| C<br>( $\mu\text{F}$ )   | DIMENSIONS<br>w x h x l<br>(mm) | MASS<br>(g) <sup>(1)</sup> | CATALOG NUMBER BFC2 383 XXYYY AND PACKAGING |                            |                |                          |
|--|---------------------------------|----------------------------|---|----------------------------|----------------|--------------------------|
|  |                                 |                            | LOOSE IN BOX                                |                            | REEL           | C-VALUE                  |
|  |                                 |                            | Leads<br>3.5 $\pm$ 0.3 mm                   | Leads<br>25.0 $\pm$ 2.0 mm | Original pitch | ..YYY                    |
|  |                                 |                            | XX<br>(SPQ)                                 | XX<br>(SPQ)                | XX<br>(SPQ)    |                          |
| <b>Pitch = 22.5 mm <math>\pm</math> 0.4 mm; <math>d_t = 0.80\text{ mm} \pm 0.08\text{ mm}</math></b> |                                 |                            | <b>Pitch = 22.5 mm</b>                      |                            |                |                          |
| 0.24   | 7.0 x 116.5 x 26.0              | 3.0                        | 10...<br>(200)                              | 14...<br>(250)             | 12...<br>(550) | 244                      |
| 0.27<br>0.30<br>0.33   | 8.5 x 18.0 x 26.0               | 4.2                        | 10...<br>(200)                              | 14...<br>(250)             | 12...<br>(450) | 274<br>304<br>334        |
| 0.36<br>0.39<br>0.43   | 10.0 x 19.5 x 26.0              | 5.3                        | 10...<br>(200)                              | 14...<br>(200)             | 12...<br>(350) | 364<br>394<br>434        |
| <b>Pitch = 27.5 mm <math>\pm</math> 0.4 mm; <math>d_t = 0.80\text{ mm} \pm 0.08\text{ mm}</math></b> |                                 |                            | <b>Pitch = 27.5 mm</b>                      |                            |                |                          |
| 0.47<br>0.51<br>0.56<br>0.62   | 11.0 x 21.0 x 31.0              | 8.0                        | 10...<br>(100)                              | 14...<br>(125)             | -              | 474<br>514<br>564<br>624 |
| 0.68<br>0.75<br>0.82   | 13.0 x 23.0 x 31.0              | 9.7                        | 10...<br>(100)                              | 14...<br>(125)             | -              | 684<br>754<br>824        |
| 0.91<br>1.<br>1.1  | 15.0 x 25.0 x 31.0              | 12.6                       | 10...<br>(100)                              | 14...<br>(125)             | -              | 914<br>105<br>115        |
| 1.2<br>1.3<br>1.5  | 18.0 x 28.0 x 31.0              | 16.3                       | 10...<br>(100)                              | 14...<br>(100)             | -              | 125<br>135<br>155        |

**Notes**

- (1) Net weight for short lead products only
- SPQ = Standard Packaging Quantity

**SPECIFIC REFERENCE DATA (630 Vdc)**

| DESCRIPTION  | VALUE   |                          |
|--|---|--------------------------|
| Tangent of loss angle:<br>C $\leq$ 0.15 $\mu\text{F}$<br>0.15 $\mu\text{F}$ < C $\leq$ 0.22 $\mu\text{F}$<br>0.22 $\mu\text{F}$ < C $\leq$ 0.3 $\mu\text{F}$<br>0.3 $\mu\text{F}$ < C $\leq$ 0.47 $\mu\text{F}$<br>0.47 $\mu\text{F}$ < C $\leq$ 0.68 $\mu\text{F}$<br>0.68 $\mu\text{F}$ < C $\leq$ 1.0 $\mu\text{F}$ | at 10 kHz   | at 100 kHz               |
|  | $\leq 5 \times 10^{-4}$   | $\leq 15 \times 10^{-4}$ |
|  | $\leq 8 \times 10^{-4}$   | $\leq 25 \times 10^{-4}$ |
|  | $\leq 8 \times 10^{-4}$   | $\leq 30 \times 10^{-4}$ |
|  | $\leq 10 \times 10^{-4}$  | $\leq 40 \times 10^{-4}$ |
|  | $\leq 10 \times 10^{-4}$  | $\leq 45 \times 10^{-4}$ |
|  | $\leq 10 \times 10^{-4}$  | $\leq 50 \times 10^{-4}$ |
| Rated voltage pulse slope (dU/dt) <sub>R</sub> :<br>C $\leq$ 0.056 $\mu\text{F}$<br>0.056 $\mu\text{F}$ < C $\leq$ 0.15 $\mu\text{F}$<br>0.15 $\mu\text{F}$ < C $\leq$ 0.3 $\mu\text{F}$<br>0.3 $\mu\text{F}$ < C $\leq$ 0.75 $\mu\text{F}$<br>0.75 $\mu\text{F}$ < C $\leq$ 1.0 $\mu\text{F}$                         | 700 V/ $\mu\text{s}$<br>1400 V/ $\mu\text{s}$<br>470 V/ $\mu\text{s}$<br>300 V/ $\mu\text{s}$<br>210 V/ $\mu\text{s}$ |                          |
| R between leads, for C $\leq$ 1 $\mu\text{F}$ at 100 V, 1 min  | > 100 000 M $\Omega$  |                          |
| R between leads and case, 100 V, 1 min   | > 30 000 M $\Omega$   |                          |
| Ionization (AC) voltage (typical value) at 50 pC peak discharge  | > 250 V   |                          |
| Withstanding (DC) voltage (cut off current 10 mA), rise time 100 V/s   | 1000 V, 1 min   |                          |
| Withstanding (DC) voltage between leads and case   | 2840 V, 1 min   |                          |
| Maximum application temperature  | 105 °C  |                          |

# MMKP383



Vishay BCcomponents AC and Pulse Double Metallized Polypropylene Film Capacitors MMKP Radial Potted Type

$U_{Rdc} = 630\text{ V}$ ;  $U_{Rac} = 220\text{ V}$ ;  $U_{p-p} = 630\text{ V}$ ; C-tol. =  $\pm 5\%$

| C<br>( $\mu\text{F}$ )   | DIMENSIONS<br>w x h (h') x l<br>(mm) | MASS<br>(g) <sup>(1)</sup> | CATALOG NUMBER BFC2 383 XXYYY AND PACKAGING |                            |                        |                                   |              | C-VALUE<br><br>..YYY |
|--|--------------------------------------|----------------------------|---|----------------------------|------------------------|-----------------------------------|--------------|----------------------|
|  |                                      |                            | LOOSE IN BOX                                |                            | Original pitch         | REEL                              |              |                      |
|  |                                      |                            | Leads<br>3.5 $\pm$ 0.3 mm                   | Leads<br>25.0 $\pm$ 2.0 mm |                        | Pitch = 7.5 mm (bent back)        |              |                      |
|  |                                      |                            | XX<br>(SPQ)                                 | XX<br>(SPQ)                | XX<br>(SPQ)            | XX<br>(SPQ)                       | XX<br>(SPQ)  |                      |
| <b>Pitch = 15 mm <math>\pm</math> 0.4 mm; d<sub>t</sub> = 0.80 mm <math>\pm</math> 0.08 mm</b>   |                                      |                            |   |                            | <b>Pitch = 15 mm</b>   | <b>Pitch = 7.5 mm (bent back)</b> |              |                      |
| 0.03   | 5.0 x 11.0 (13.0) x 17.5             | 1.1                        | <b>20...</b>                                | <b>24...</b>               | <b>22...</b>           | <b>23...</b>                      | <b>25...</b> | <b>303</b>           |
| 0.033  |                                      |                            | (1250)                                      | (1000)                     | (2200)                 | (950)                             | (550)        | <b>333</b>           |
| 0.036  |                                      |                            |   |                            |                        |                                   |              | <b>363</b>           |
| 0.039  | 6.0 x 12.0 (14.0) x 17.5             | 1.4                        | <b>20...</b>                                | <b>24...</b>               | <b>22...</b>           | <b>23...</b>                      | <b>25...</b> | <b>393</b>           |
| 0.043  |                                      |                            | (1000)                                      | (1000)                     | (900)                  | (800)                             | (450)        | <b>433</b>           |
| 0.047  |                                      |                            |   |                            |                        |                                   |              | <b>473</b>           |
| 0.051  |                                      |                            |   |                            |                        |                                   |              | <b>513</b>           |
| 0.056  |                                      |                            |   |                            |                        |                                   |              | <b>563</b>           |
| 0.062  | 7.0 x 13.5 (15.5) x 17.5             | 1.8                        | <b>20...</b>                                | <b>24...</b>               | <b>22...</b>           | <b>23...</b>                      | <b>25...</b> | <b>623</b>           |
| 0.068  |                                      |                            | (750)                                       | (500)                      | (800)                  | (700)                             | (400)        | <b>683</b>           |
| 0.075  |                                      |                            |   |                            |                        |                                   |              | <b>753</b>           |
| 0.082  | 8.5 x 15.0 (17.0) x 17.5             | 2.5                        | <b>20...</b>                                | <b>24...</b>               | <b>22...</b>           | <b>23...</b>                      | <b>25...</b> | <b>823</b>           |
| 0.091  |                                      |                            | (750)                                       | (500)                      | (650)                  | (550)                             | (300)        | <b>913</b>           |
| 0.1  |                                      |                            |   |                            |                        |                                   |              | <b>104</b>           |
| 0.11   |                                      |                            |   |                            |                        |                                   |              | <b>114</b>           |
| 0.12   | 10.0 x 16.5 (18.5) x 17.5            | 3.3                        | <b>20...</b>                                | <b>24...</b>               | <b>22...</b>           | <b>23...</b>                      | <b>25...</b> | <b>124</b>           |
| 0.13   |                                      |                            | (500)                                       | (450)                      | (600)                  | (500)                             | (250)        | <b>134</b>           |
| 0.15   |                                      |                            |   |                            |                        |                                   |              | <b>154</b>           |
| <b>Pitch = 22.5 mm <math>\pm</math> 0.4 mm; d<sub>t</sub> = 0.80 mm <math>\pm</math> 0.08 mm</b> |                                      |                            |   |                            | <b>Pitch = 22.5 mm</b> |                                   |              |                      |
| 0.16   | 8.5 x 18.0 x 26.0                    | 4.2                        | <b>20...</b>                                | <b>24...</b>               | <b>22...</b>           | -                                 | -            | <b>164</b>           |
| 0.18   |                                      |                            | (200)                                       | (250)                      | (450)                  |                                   |              | <b>184</b>           |
| 0.2  |                                      |                            |   |                            |                        |                                   |              | <b>204</b>           |
| 0.22   |                                      |                            |   |                            |                        |                                   |              | <b>224</b>           |
| 0.24   | 10.0 x 19.5 x 26.0                   | 5.3                        | <b>20...</b>                                | <b>24...</b>               | <b>22...</b>           | -                                 | -            | <b>174</b>           |
| 0.27   |                                      |                            | (200)                                       | (200)                      | (350)                  |                                   |              | <b>304</b>           |
| 0.3  |                                      |                            |   |                            |                        |                                   |              |                      |
| <b>Pitch = 27.5 mm <math>\pm</math> 0.4 mm; d<sub>t</sub> = 0.80 mm <math>\pm</math> 0.08 mm</b> |                                      |                            |   |                            | <b>Pitch = 27.5 mm</b> |                                   |              |                      |
| 0.33   | 11.0 x 21.0 x 31.0                   | 8.0                        | <b>20...</b>                                | <b>24...</b>               |                        |                                   |              | <b>334</b>           |
| 0.36   |                                      |                            | (750)                                       | (125)                      |                        |                                   |              | <b>364</b>           |
| 0.39   |                                      |                            |   |                            |                        |                                   |              | <b>394</b>           |
| 0.43   |                                      |                            |   |                            |                        |                                   |              | <b>434</b>           |
| 0.47   | 13.0 x 23.0 x 31.0                   | 9.7                        | <b>20...</b>                                | <b>24...</b>               |                        |                                   |              | <b>474</b>           |
| 0.51   |                                      |                            | (500)                                       | (125)                      |                        |                                   |              | <b>514</b>           |
| 0.56   |                                      |                            |   |                            |                        |                                   |              | <b>564</b>           |
| 0.62   | 15.0 x 25.0 x 31.0                   | 12.6                       | <b>20...</b>                                | <b>24...</b>               |                        |                                   |              | <b>624</b>           |
| 0.68   |                                      |                            | (100)                                       | (125)                      |                        |                                   |              | <b>684</b>           |
| 0.75   |                                      |                            |   |                            |                        |                                   |              | <b>754</b>           |
| 0.82   | 18.0 x 28.0 x 31.0                   | 16.3                       | <b>20...</b>                                | <b>24...</b>               |                        |                                   |              | <b>824</b>           |
| 0.91   |                                      |                            | (100)                                       | (100)                      |                        |                                   |              | <b>914</b>           |
| 1.0  |                                      |                            |   |                            |                        |                                   |              | <b>105</b>           |

**Notes**

<sup>(1)</sup> Net weight for short lead products only

- SPQ = Standard Packaging Quantity



AC and Pulse Double Metallized Polypropylene  
Film Capacitors MMKP Radial Potted Type

Vishay BCcomponents

**SPECIFIC REFERENCE DATA (1000 Vdc)**

| DESCRIPTION  | VALUE                  |                         |
|--|------------------------|-------------------------|
|  | at 10 kHz              | at 100 kHz              |
| Tangent of loss angle:<br>C ≤ 0.062 μF                               | ≤ 5 x 10 <sup>-4</sup> | ≤ 15 x 10 <sup>-4</sup> |
| 0.062 μF < C ≤ 0.13 μF   | ≤ 6 x 10 <sup>-4</sup> | ≤ 20 x 10 <sup>-4</sup> |
| 0.13 μF < C ≤ 0.22 μF  | ≤ 8 x 10 <sup>-4</sup> | ≤ 25 x 10 <sup>-4</sup> |
| 0.22 μF < C ≤ 0.33 μF  | ≤ 8 x 10 <sup>-4</sup> | ≤ 30 x 10 <sup>-4</sup> |
| 0.33 μF < C ≤ 0.47 μF  | ≤ 8 x 10 <sup>-4</sup> | ≤ 35 x 10 <sup>-4</sup> |
| Rated voltage pulse slope (dU/dt) <sub>R</sub> :<br>C ≤ 0.024 μF     | 1700 V/μs              |                         |
| 0.024 μF < C ≤ 0.062 μF  | 3300 V/μs              |                         |
| 0.062 μF < C ≤ 0.13 μF   | 1200 V/μs              |                         |
| 0.13 μF < C ≤ 0.33 μF  | 700 V/μs               |                         |
| 0.33 μF < C ≤ 0.47 μF  | 470 V/μs               |                         |
| R between leads, for C ≤ 1 μF at 500 V, 1 min                        | > 100 000 MΩ           |                         |
| R between leads and case, 500 V, 1 min                               | > 30 000 MΩ            |                         |
| Ionization (AC) voltage (typical value) at 50 pC peak discharge      | > 440 V                |                         |
| Withstanding (DC) voltage (cut off current 10 mA), rise time 100 V/s | 1600 V, 1 min          |                         |
| Withstanding (DC) voltage between leads and case                     | 2840 V, 1 min          |                         |
| Maximum application temperature                                      | 105 °C                 |                         |

**U<sub>Rdc</sub> = 1000 V; U<sub>Rac</sub> = 350 V; U<sub>p-p</sub> = 1000 V; C-tol. = ± 5 %**

| C<br>(μF)  | DIMENSIONS<br>w x h (h') x l<br>(mm) | MASS<br>(g) <sup>(1)</sup> | CATALOG NUMBER BFC2 383 XYYYY AND PACKAGING |                        |                        |                                   |                         |                          |
|--|--------------------------------------|----------------------------|---|------------------------|------------------------|-----------------------------------|-------------------------|--------------------------|
|  |                                      |                            | LOOSE IN BOX                                |                        | Original pitch         | REEL                              |                         | C-VALUE<br><br>..YYY     |
|  |                                      |                            | Leads<br>3.5 ± 0.3 mm                       | Leads<br>25.0 ± 2.0 mm |                        | Pitch = 7.5 mm (bent back)        |                         |                          |
|  |                                      |                            | XX<br>(SPQ)                                 | XX<br>(SPQ)            | XX<br>(SPQ)            | Ø 500 mm<br>XX<br>(SPQ)           | Ø 356 mm<br>XX<br>(SPQ) |                          |
| <b>Pitch = 15 mm ± 0.4 mm; d<sub>t</sub> = 0.80 mm ± 0.08 mm</b> |                                      |                            |   |                        | <b>Pitch = 15 mm</b>   | <b>Pitch = 7.5 mm (bent back)</b> |                         |                          |
| 0.0043   | 5.0 x 11.0 (13.0) x 17.5             | 1.1                        | <b>30...</b><br>(1250)                      | <b>34...</b><br>(1000) | <b>32...</b><br>(1100) | <b>33...</b><br>(950)             | <b>35...</b><br>(550)   | <b>432</b>               |
| 0.0047   |                                      |                            |   |                        |                        |                                   |                         | <b>472</b>               |
| 0.0051   |                                      |                            |   |                        |                        |                                   |                         | <b>512</b>               |
| 0.0056   |                                      |                            |   |                        |                        |                                   |                         | <b>562</b>               |
| 0.0062   |                                      |                            |   |                        |                        |                                   |                         | <b>622</b>               |
| 0.0068   |                                      |                            |   |                        |                        |                                   |                         | <b>682</b>               |
| 0.0075   |                                      |                            |   |                        |                        |                                   |                         | <b>752</b>               |
| 0.0082   |                                      |                            |   |                        |                        |                                   |                         | <b>822</b>               |
| 0.0091   |                                      |                            |   |                        |                        |                                   |                         | <b>912</b>               |
| 0.01   |                                      |                            |   |                        |                        |                                   |                         | <b>103</b>               |
| 0.011  |                                      |                            |   |                        |                        |                                   |                         | <b>113</b>               |
| 0.012  |                                      |                            |   |                        |                        |                                   |                         | <b>123</b>               |
| 0.013  |                                      |                            |   |                        |                        |                                   |                         | <b>133</b>               |
| 0.015  |                                      |                            |   |                        |                        |                                   |                         | <b>153</b>               |
| 0.016  |                                      |                            |   |                        |                        |                                   |                         | <b>163</b>               |
| 0.018  |                                      |                            |   |                        |                        |                                   |                         | 6.0 x 12.0 (14.0) x 17.5 |
| 0.02   | <b>203</b>                           |                            |   |                        |                        |                                   |                         |                          |
| 0.022  | <b>223</b>                           |                            |   |                        |                        |                                   |                         |                          |
| 0.024  | <b>243</b>                           |                            |   |                        |                        |                                   |                         |                          |
| 0.027  | 7.0 x 13.5 (15.5) x 17.5             | 1.8                        | <b>30...</b><br>(750)                       | <b>34...</b><br>(500)  | <b>32...</b><br>(800)  | <b>33...</b><br>(700)             | <b>35...</b><br>(400)   | <b>273</b>               |
| 0.030  |                                      |                            |   |                        |                        |                                   |                         | <b>303</b>               |
| 0.033  |                                      |                            |   |                        |                        |                                   |                         | <b>333</b>               |
| 0.036  | 8.5 x 15.0 (17.0) x 17.5             | 2.5                        | <b>30...</b><br>(750)                       | <b>34...</b><br>(500)  | <b>32...</b><br>(650)  | <b>33...</b><br>(550)             | <b>35...</b><br>(300)   | <b>363</b>               |
| 0.039  |                                      |                            |   |                        |                        |                                   |                         | <b>393</b>               |
| 0.043  |                                      |                            |   |                        |                        |                                   |                         | <b>433</b>               |
| 0.047  |                                      |                            |   |                        |                        |                                   |                         | <b>473</b>               |
| 0.051  | 10.0 x 16.5 (18.5) x 17.5            | 3.3                        | <b>30...</b><br>(500)                       | <b>34...</b><br>(450)  | <b>32...</b><br>(600)  | <b>33...</b><br>(500)             | <b>35...</b><br>(250)   | <b>513</b>               |
| 0.056  |                                      |                            |   |                        |                        |                                   |                         | <b>563</b>               |
| 0.062  |                                      |                            |   |                        |                        |                                   |                         | <b>623</b>               |

**Notes**

- <sup>(1)</sup> Net weight for short lead products only
- SPQ = Standard Packaging Quantity

# MMKP383



Vishay BCcomponents AC and Pulse Double Metallized Polypropylene Film Capacitors MMKP Radial Potted Type

| C<br>( $\mu$ F)  | DIMENSIONS<br>w x h (h') x l<br>(mm) | MASS<br>(g) <sup>(1)</sup> | CATALOG NUMBER BFC2 383 XXYYY AND PACKAGING |                |                |                          |
|--|--------------------------------------|----------------------------|---|----------------|----------------|--------------------------|
|  |                                      |                            | LOOSE IN BOX                                |                | REEL           | C-VALUE<br>..YYY         |
|  |                                      |                            | Leads                                       | Leads          | Original pitch |                          |
|  |                                      |                            | XX<br>(SPQ)                                 | XX<br>(SPQ)    | XX<br>(SPQ)    |                          |
| <b>Pitch = 22.5 mm <math>\pm</math> 0.4 mm; d<sub>t</sub> = 0.80 mm <math>\pm</math> 0.08 mm</b> |                                      |                            | <b>Pitch 22.5 mm</b>                        |                |                |                          |
| 0.068  | 7.0 x 16.5 x 26.5                    | 3.0                        | 30...<br>(200)                              | 34...<br>(250) | 32...<br>(550) | 683                      |
| 0.075<br>0.082<br>0.091  | 8.5 x 18.0 x 26.0                    | 4.2                        | 30...<br>(200)                              | 34...<br>(250) | 32...<br>(450) | 753<br>823<br>913        |
| 0.1<br>0.11<br>0.12<br>0.13  | 10.0 x 19.5 x 26.0                   | 5.3                        | 30...<br>(200)                              | 34...<br>(200) | 32...<br>(350) | 104<br>114<br>124<br>134 |
| <b>Pitch = 27.5 mm <math>\pm</math> 0.4 mm; d<sub>t</sub> = 0.80 mm <math>\pm</math> 0.08 mm</b> |                                      |                            | <b>Pitch = 27.5 mm</b>                      |                |                |                          |
| 0.15<br>0.16<br>0.18   | 11.0 x 21.0 x 31.0                   | 8.0                        | 30...<br>(100)                              | 34...<br>(125) |                | 154<br>164<br>184        |
| 0.2<br>0.22<br>0.24  | 13.0 x 23.0 x 31.0                   | 9.7                        | 30...<br>(100)                              | 34...<br>(125) |                | 204<br>224<br>244        |
| 0.27<br>0.3<br>0.33  | 15.0 x 25.0 x 31.0                   | 12.6                       | 30...<br>(100)                              | 34...<br>(125) |                | 274<br>304<br>334        |
| 0.36<br>0.39<br>0.43<br>0.47   | 18.0 x 28.0 x 31.0                   | 16.3                       | 30...<br>(100)                              | 34...<br>(100) |                | 364<br>394<br>434<br>474 |

**Notes**

- <sup>(1)</sup> Net weight for short lead products only
- SPQ = Standard Packaging Quantity

**SPECIFIC REFERENCE DATA (1400 Vdc)**

| DESCRIPTION   | VALUE                   |                          |
|---|-------------------------|--------------------------|
|   | at 10 kHz               | at 100 kHz               |
| Tangent of loss angle:<br>C $\leq$ 0.016 $\mu$ F                            | $\leq 5 \times 10^{-4}$ | $\leq 10 \times 10^{-4}$ |
| 0.016 $\mu$ F < C $\leq$ 0.039 $\mu$ F                                      | $\leq 5 \times 10^{-4}$ | $\leq 15 \times 10^{-4}$ |
| 0.039 $\mu$ F < C $\leq$ 0.13 $\mu$ F                                       | $\leq 5 \times 10^{-4}$ | $\leq 20 \times 10^{-4}$ |
| Rated voltage pulse slope (dU/dt) <sub>R</sub> :<br>C $\leq$ 0.0056 $\mu$ F | 8000 V/ $\mu$ s         |                          |
| 0.0056 $\mu$ F < C $\leq$ 0.016 $\mu$ F                                     | 15 000 V/ $\mu$ s       |                          |
| 0.016 $\mu$ F < C $\leq$ 0.039 $\mu$ F                                      | 4000 V/ $\mu$ s         |                          |
| 0.039 $\mu$ F < C $\leq$ 0.1 $\mu$ F  | 2100 V/ $\mu$ s         |                          |
| 0.1 $\mu$ F < C $\leq$ 0.13 $\mu$ F   | 1500 V/ $\mu$ s         |                          |
| R between leads, for C $\leq$ 1 $\mu$ F at 500 V, 1 min                     | > 100 000 M $\Omega$    |                          |
| R between leads and case, 500 V, 1 min                                      | > 30 000 M $\Omega$     |                          |
| Ionization (AC) voltage (typical value) at 20 pC peak discharge             | > 500 V                 |                          |
| Withstanding (DC) voltage (cut off current 10 mA), rise time 100 V/s        | 2250 V, 1 min           |                          |
| Withstanding (DC) voltage between leads and case                            | 2840 V, 1 min           |                          |
| Maximum application temperature   | 105 °C                  |                          |





AC and Pulse Double Metallized Polypropylene  
Film Capacitors MMKP Radial Potted Type

Vishay BCcomponents

$U_{Rdc} = 1400\text{ V}$ ;  $U_{Rac} = 500\text{ V}$ ;  $U_{p-p} = 1400\text{ V}$ ; C-tol. =  $\pm 5\%$

| C<br>( $\mu\text{F}$ )   | DIMENSIONS<br>w x h (h') x l<br>(mm) | MASS<br>(g) <sup>(1)</sup> | CATALOG NUMBER BFC2 383 XXYYY AND PACKAGING |                            |                 |                                   |                      |   | C-VALUE<br><br>..YYY |
|--|--------------------------------------|----------------------------|---|----------------------------|-----------------|-----------------------------------|----------------------|---|----------------------|
|  |                                      |                            | LOOSE IN BOX                                |                            |                 | REEL                              |                      |   |                      |
|  |                                      |                            | Leads<br>3.5 $\pm$ 0.3 mm                   | Leads<br>25.0 $\pm$ 2.0 mm | Original pitch  | Pitch = 7.5 mm (bent back)        |                      | ..YYY   |                      |
|  |                                      |                            | XX<br>(SPQ)                                 | XX<br>(SPQ)                | XX<br>(SPQ)     | $\varnothing$ 500 mm              | $\varnothing$ 356 mm |   |                      |
| <b>Pitch = 15 mm <math>\pm</math> 0.4 mm; <math>d_t = 0.80\text{ mm} \pm 0.08\text{ mm}</math></b> |                                      |                            | <b>Pitch = 15 mm</b>                        |                            |                 | <b>Pitch = 7.5 mm (bent back)</b> |                      |   |                      |
| 0.0022<br>0.0024<br>0.0027<br>0.003<br>0.0033<br>0.0036<br>0.0039                                  | 5.0 x 11.0 (13.0) x 17.5             | 1.1                        | 40...<br>(1250)                             | 44...<br>(1000)            | 42...<br>(1100) | 43...<br>(950)                    | 45...<br>(550)       | 222<br>242<br>272<br>302<br>332<br>362<br>392 |                      |
| 0.0043<br>0.0047<br>0.0051<br>0.0056   | 6.0 x 12.0 (14.0) x 17.5             | 1.4                        | 40...<br>(1000)                             | 44...<br>(1000)            | 42...<br>(900)  | 43...<br>(800)                    | 45...<br>(450)       | 432<br>472<br>512<br>562                      |                      |
| 0.0062<br>0.0068<br>0.0075<br>0.0082   | 7.0 x 13.5 (15.5) x 17.5             | 1.8                        | 40...<br>(750)                              | 44...<br>(500)             | 42...<br>(800)  | 43...<br>(700)                    | 45...<br>(400)       | 622<br>682<br>752<br>822                      |                      |
| 0.0091<br>0.01<br>0.011<br>0.012   | 8.5 x 15.0 (17.0) x 17.5             | 2.5                        | 40...<br>(750)                              | 44...<br>(500)             | 42...<br>(650)  | 43...<br>(550)                    | 45...<br>(300)       | 912<br>103<br>113<br>123                      |                      |
| 0.013<br>0.015<br>0.016  | 10.0 x 16.5 (18.5) x<br>17.5         | 3.3                        | 40...<br>(500)                              | 44...<br>(450)             | 42...<br>(600)  | 43...<br>(500)                    | 45...<br>(250)       | 133<br>153<br>163                             |                      |
| <b>Pitch = 22.5 <math>\pm</math> 0.4 mm; <math>d_t = 0.80\text{ mm} \pm 0.08\text{ mm}</math></b>  |                                      |                            | <b>Pitch = 22.5 mm</b>                      |                            |                 |                                   |                      |   |                      |
| 0.018<br>0.02  | 7.0 x 16.5 x 26.0                    | 3                          | 40...<br>(200)                              | 44...<br>(250)             | 42...<br>(550)  | -                                 | -                    | 183<br>203                                    |                      |
| 0.022<br>0.024<br>0.027  | 8.5 x 18.0 x 26.0                    | 4.2                        | 40...<br>(200)                              | 44...<br>(250)             | 42...<br>(450)  | -                                 | -                    | 223<br>243<br>273                             |                      |
| 0.03<br>0.033<br>0.036<br>0.039  | 10.0 x 19.5 x 26.0                   | 5.3                        | 40...<br>(200)                              | 44...<br>(200)             | 42...<br>(350)  | -                                 | -                    | 303<br>333<br>363<br>393                      |                      |
| <b>Pitch = 27.5 <math>\pm</math> 0.4 mm; <math>d_t = 0.80\text{ mm} \pm 0.08\text{ mm}</math></b>  |                                      |                            | <b>Pitch = 27.5 mm</b>                      |                            |                 |                                   |                      |   |                      |
| 0.043<br>0.047<br>0.051<br>0.056   | 11.0 x 21.0 x 31.0                   | 8                          | 40...                                       | 44...                      |                 |                                   |                      | 433<br>473<br>513<br>563                      |                      |
| 0.062<br>0.068<br>0.075  | 13.0 x 23.0 x 31.0                   | 9.7                        | 40...<br>(100)                              | 44...<br>(125)             |                 |                                   |                      | 623<br>683<br>753                             |                      |
| 0.082<br>0.091<br>0.1  | 15.0 x 25.0 x 31.0                   | 12.6                       | 40...<br>(100)                              | 44...<br>(125)             |                 |                                   |                      | 823<br>913<br>104                             |                      |
| 0.11<br>0.12<br>0.13   | 18.0 x 28.0 x 31.0                   | 16.3                       | 40...<br>(100)                              | 44...<br>(100)             |                 |                                   |                      | 114<br>124<br>134                             |                      |

**Notes**

(1) Net weight for short lead products only

• SPQ = Standard Packaging Quantity

# MMKP383



Vishay BCcomponents AC and Pulse Double Metallized Polypropylene Film Capacitors MMKP Radial Potted Type

## SPECIFIC REFERENCE DATA (1600 Vdc)

| DESCRIPTION   | VALUE                  |                         |
|---|------------------------|-------------------------|
| Tangent of loss angle:<br>C ≤ 0.015 μF<br>0.015 μF < C ≤ 0.15 μF  | at 10 kHz              | at 100 kHz              |
|   | ≤ 5 x 10 <sup>-4</sup> | ≤ 15 x 10 <sup>-4</sup> |
|   | ≤ 5 x 10 <sup>-4</sup> | ≤ 20 x 10 <sup>-4</sup> |
| Rated voltage pulse slope (dU/dt) <sub>R</sub> :<br>C ≤ 0.0056 μF<br>0.0056 μF < C ≤ 0.0075 μF<br>0.0075 μF < C ≤ 0.039 μF<br>0.039 μF < C ≤ 0.1 μF<br>0.1 μF < C ≤ 0.15 μF | 8000 V/μs              |                         |
|   | 15 000 V/μs            |                         |
|   | 3100 V/μs              |                         |
|   | 1800 V/μs              |                         |
|   | 1200 V/μs              |                         |
| R between leads, for C ≤ 1 μF at 500 V, 1 min   | > 100 000 MΩ           |                         |
| R between leads and case, 500 V, 1 min  | > 30 000 MΩ            |                         |
| Ionization (AC) voltage (typical value) at 20 pC peak discharge   | > 660 V                |                         |
| Withstanding (DC) voltage (cut off current 10 mA), rise time 100 V/s  | 2560 V, 1 min          |                         |
| Withstanding (DC) voltage between leads and case  | 2840 V, 1 min          |                         |
| Maximum application temperature   | 105 °C                 |                         |

**U<sub>Rdc</sub> = 1600 V; U<sub>Rac</sub> = 550 V; U<sub>p-p</sub> = 1600 V; C-tol. = ± 5 %**

| C<br>(μF)  | DIMENSIONS<br>w x h (h') x l<br>(mm) | MASS<br>(g) <sup>(1)</sup> | CATALOG NUMBER BFC2 383 XXYYY AND PACKAGING |                     |                        |                                   |                | C-VALUE<br><br>..YYY            |
|--|--------------------------------------|----------------------------|---|---------------------|------------------------|-----------------------------------|----------------|---------------------------------|
|  |                                      |                            | LOOSE IN BOX                                |                     | Original pitch         | REEL                              |                |                                 |
|  |                                      |                            | Leads<br>3.5 ± 0.3                          | Leads<br>25.0 ± 2.0 |                        | Pitch = 7.5 mm (bent back)        |                |                                 |
|  |                                      |                            | XX<br>(SPQ)                                 | XX<br>(SPQ)         | XX<br>(SPQ)            | XX<br>(SPQ)                       | XX<br>(SPQ)    |                                 |
| <b>Pitch = 15 mm ± 0.4 mm; d<sub>t</sub> = 0.80 mm ± 0.08 mm</b> |                                      |                            |   |                     | <b>Pitch = 15 mm</b>   | <b>Pitch = 7.5 mm (bent back)</b> |                |                                 |
| 0.0027<br>0.003<br>0.0033<br>0.0036<br>0.0039                    | 5.0 x 11.0 (13.0) x 17.5             | 1.1                        | 50...<br>(1250)                             | 54...<br>(1000)     | 52...<br>(1100)        | 53...<br>(950)                    | 55...<br>(550) | 272<br>302<br>332<br>362<br>392 |
| 0.0043<br>0.0047<br>0.0051<br>0.0056                             | 6.0 x 12.0 (14.0) x 17.5             | 1.4                        | 50...<br>(1000)                             | 54...<br>(1000)     | 52...<br>(900)         | 53...<br>(800)                    | 55...<br>(450) | 432<br>472<br>512<br>562        |
| 0.0062<br>0.0068<br>0.0075                                       | 7.0 x 13.5 (15.5) x 17.5             | 1.8                        | 50...<br>(750)                              | 54...<br>(500)      | 52...<br>(800)         | 53...<br>(700)                    | 55...<br>(400) | 622<br>682<br>752               |
| 0.0082<br>0.0091<br>0.01<br>0.011                                | 8.5 x 15.0 (17.0) x 17.5             | 2.5                        | 50...<br>(750)                              | 54...<br>(500)      | 52...<br>(650)         | 53...<br>(550)                    | 55...<br>(300) | 822<br>912<br>103<br>113        |
| 0.012<br>0.013<br>0.015  | 10.0 x 16.5 (18.5) x 17.5            | 3.3                        | 50...<br>(500)                              | 54...<br>(450)      | 52...<br>(600)         | 53...<br>(500)                    | 55...<br>(250) | 123<br>133<br>153               |
| <b>Pitch = 22.5 ± 0.4 mm; d<sub>t</sub> = 0.80 mm ± 0.08 mm</b>  |                                      |                            |   |                     | <b>Pitch = 22.5 mm</b> |                                   |                |                                 |
| 0.016<br>0.018<br>0.02   | 7.0 x 16.5 x 26.0                    | 3.0                        | 50...<br>(200)                              | 54...<br>(250)      | 52...<br>(550)         | -                                 | -              | 163<br>183<br>203               |
| 0.022<br>0.024<br>0.027<br>0.03                                  | 8.5 x 18.0 x 26.0                    | 4.2                        | 50...<br>(200)                              | 54...<br>(250)      | 52...<br>(450)         | -                                 | -              | 223<br>243<br>273<br>303        |
| 0.033<br>0.036<br>0.039  | 10.0 x 19.5 x 26.0                   | 5.3                        | 50...<br>(200)                              | 54...<br>(200)      | 52...<br>(350)         | -                                 | -              | 333<br>363<br>393               |

### Notes

- <sup>(1)</sup> Net weight for short lead products only
- SPQ = Standard Packaging Quantity



AC and Pulse Double Metallized Polypropylene  
Film Capacitors MMKP Radial Potted Type

Vishay BCcomponents

$U_{Rdc} = 1600\text{ V}$ ;  $U_{Rac} = 550\text{ V}$ ;  $U_{p-p} = 1600\text{ V}$ ; C-tol. =  $\pm 5\%$

| C<br>( $\mu\text{F}$ )   | DIMENSIONS<br>w x h (h') x l<br>(mm) | MASS<br>(g) <sup>(1)</sup> | CATALOG NUMBER BFC2 383 XXYYY AND PACKAGING |                         |                |                            |                      | C-VALUE<br><br>..YYY |
|--|--------------------------------------|----------------------------|---|-------------------------|----------------|----------------------------|----------------------|----------------------|
|  |                                      |                            | LOOSE IN BOX                                |                         | REEL           |                            |                      |                      |
|  |                                      |                            | Leads<br>3.5 $\pm$ 0.3                      | Leads<br>25.0 $\pm$ 2.0 | Original pitch | Pitch = 7.5 mm (bent back) |                      |                      |
|  |                                      |                            |   |                         |                | $\varnothing$ 500 mm       | $\varnothing$ 356 mm |                      |
| XX<br>(SPQ)  | XX<br>(SPQ)                          | XX<br>(SPQ)                | XX<br>(SPQ)                                 | XX<br>(SPQ)             |                |                            |                      |                      |
| Pitch = 27.5 $\pm$ 0.4 mm; $d_t = 0.80\text{ mm} \pm 0.08\text{ mm}$ |                                      |                            | Pitch = 27.5 mm                             |                         |                |                            |                      |                      |
| 0.043  | 11.0 x 21.0 x 31.0                   | 8                          | 50...<br>(100)                              | 54...<br>(125)          |                | 433                        |                      |                      |
| 0.047  |                                      |                            |   |                         |                | 473                        |                      |                      |
| 0.051  |                                      |                            |   |                         |                | 513                        |                      |                      |
| 0.056  |                                      |                            |   |                         |                | 563                        |                      |                      |
| 0.062  | 13.0 x 23.0 x 31.0                   | 9.7                        | 50...<br>(100)                              | 54...<br>(125)          |                | 623                        |                      |                      |
| 0.068  |                                      |                            |   |                         |                | 683                        |                      |                      |
| 0.075  |                                      |                            |   |                         |                | 753                        |                      |                      |
| 0.082  | 15.0 x 25.0 x 31.0                   | 12.6                       | 50...<br>(100)                              | 54...<br>(125)          |                | 823                        |                      |                      |
| 0.091  |                                      |                            |   |                         |                | 913                        |                      |                      |
| 0.1  |                                      |                            |   |                         |                | 104                        |                      |                      |
| 0.11   | 18.0 x 28.0 x 31.0                   | 16.3                       | 50...<br>(100)                              | 54...<br>(100)          | 114            |                            |                      |                      |
| 0.12   |                                      |                            |   |                         | 124            |                            |                      |                      |
| 0.13   |                                      |                            |   |                         | 134            |                            |                      |                      |
| 0.15   |                                      |                            |   |                         | 154            |                            |                      |                      |

**Notes**

<sup>(1)</sup> Net weight for short lead products only

- SPQ = Standard Packaging Quantity

**SPECIFIC REFERENCE DATA (2000 Vdc)**

| DESCRIPTION  | VALUE   |  |
|--|---|--|
|  | at 10 kHz   | at 100 kHz   |
| Tangent of loss angle:<br>C $\leq$ 0.01 $\mu\text{F}$<br>0.01 $\mu\text{F}$ < C $\leq$ 0.1 $\mu\text{F}$   | $\leq 5 \times 10^{-4}$<br>$\leq 10 \times 10^{-4}$   | $\leq 15 \times 10^{-4}$<br>$\leq 18 \times 10^{-4}$ |
| Rated voltage pulse slope (dU/dt) <sub>R</sub> :<br>C $\leq$ 0.0036 $\mu\text{F}$<br>0.0036 $\mu\text{F}$ < C $\leq$ 0.01 $\mu\text{F}$<br>0.01 $\mu\text{F}$ < C $\leq$ 0.024 $\mu\text{F}$<br>0.024 $\mu\text{F}$ < C $\leq$ 0.068 $\mu\text{F}$<br>0.068 $\mu\text{F}$ < C $\leq$ 0.1 $\mu\text{F}$ | 11 000 V/ $\mu\text{s}$<br>20 000 V/ $\mu\text{s}$<br>4400 V/ $\mu\text{s}$<br>2500 V/ $\mu\text{s}$<br>1800 V/ $\mu\text{s}$ |  |
| R between leads, for C $\leq$ 1 $\mu\text{F}$ at 500 V, 1 min  | > 100 000 M $\Omega$  |  |
| R between leads and case, 500 V, 1 min   | > 30 000 M $\Omega$   |  |
| Ionization (AC) voltage (typical value) at 20 pC peak discharge  | > 750 V   |  |
| Withstanding (DC) voltage (cut off current 10 mA), rise time 100 V/s   | 3200 V, 1 min   |  |
| Withstanding (DC) voltage between leads and case   | 2840 V, 1 min   |  |
| Maximum application temperature  | 105 °C  |  |

# MMKP383



## Vishay BCcomponents AC and Pulse Double Metallized Polypropylene Film Capacitors MMKP Radial Potted Type

$U_{Rdc} = 2000\text{ V}$ ;  $U_{Rac} = 700\text{ V}$ ;  $U_{p-p} = 2000\text{ V}$ ;  $C\text{-tol.} = \pm 5\%$

| C<br>( $\mu\text{F}$ )   | DIMENSIONS<br>w x h (h') x l<br>(mm) | MASS<br>(g) <sup>(1)</sup> | CATALOG NUMBER BFC2 383 XXYYY AND PACKAGING |                         |                        |                                   |             | C-VALUE<br><br>..YYY |       |     |
|--|--------------------------------------|----------------------------|---|-------------------------|------------------------|-----------------------------------|-------------|----------------------|-------|-----|
|  |                                      |                            | LOOSE IN BOX                                |                         | Original pitch         | REEL                              |             |                      |       |     |
|  |                                      |                            | Leads<br>3.5 $\pm$ 0.3                      | Leads<br>25.0 $\pm$ 2.0 |                        | Pitch = 7.5 mm (bent back)        |             |                      |       |     |
|  |                                      |                            | XX<br>(SPQ)                                 | XX<br>(SPQ)             | XX<br>(SPQ)            | XX<br>(SPQ)                       | XX<br>(SPQ) |                      |       |     |
| <b>Pitch = 15 mm <math>\pm</math> 0.4 mm; <math>d_t = 0.80\text{ mm} \pm 0.08\text{ mm}</math></b>   |                                      |                            |   |                         | <b>Pitch = 15 mm</b>   | <b>Pitch = 7.5 mm (bent back)</b> |             |                      |       |     |
| 0.001  | 5.0 x 11.0 (13.0) x 17.5             | 1.1                        |   |                         |                        |                                   |             | 102                  |       |     |
| 0.0011   |                                      |                            |   |                         |                        |                                   |             | 112                  |       |     |
| 0.0012   |                                      |                            |   |                         |                        |                                   |             | 122                  |       |     |
| 0.0013   |                                      |                            |   |                         |                        |                                   |             | 132                  |       |     |
| 0.0015   |                                      |                            |   |                         | 60...                  | 64...                             | 62...       | 63...                | 65... | 152 |
| 0.0016   |                                      |                            |   |                         | (1250)                 | (1000)                            | (1100)      | (950)                | (550) | 162 |
| 0.0018   |                                      |                            |   |                         |                        |                                   |             |                      |       | 182 |
| 0.002  |                                      |                            |   |                         |                        |                                   |             |                      |       | 202 |
| 0.0022   |                                      |                            |   |                         |                        |                                   |             |                      |       | 222 |
| 0.0024   |                                      |                            |   |                         |                        |                                   |             |                      |       | 242 |
| 0.0027   | 6.0 x 12.0 (14.0) x 17.5             | 1.4                        |   |                         |                        |                                   |             | 272                  |       |     |
| 0.003  |                                      |                            |   |                         |                        |                                   |             | 302                  |       |     |
| 0.0033   |                                      |                            |   |                         | 60...                  | 64...                             | 62...       | 63...                | 65... | 332 |
| 0.0036   |                                      |                            |   |                         | (1000)                 | (1000)                            | (900)       | (800)                | (450) | 362 |
| 0.0039   | 7.0 x 13.5 (15.5) x 17.5             | 1.8                        |   |                         |                        |                                   |             | 392                  |       |     |
| 0.0043   |                                      |                            |   |                         | 60...                  | 64...                             | 62...       | 63...                | 65... | 432 |
| 0.0047   |                                      |                            |   |                         | (750)                  | (500)                             | (800)       | (700)                | (400) | 472 |
| 0.0051   | 8.5 x 15.0 (17.0) x 17.5             | 2.5                        |   |                         |                        |                                   |             | 512                  |       |     |
| 0.0056   |                                      |                            |   |                         | 60...                  | 64...                             | 62...       | 63...                | 65... | 562 |
| 0.0062   |                                      |                            |   |                         | (750)                  | (500)                             | (650)       | (550)                | (300) | 622 |
| 0.0068   |                                      |                            |   |                         |                        |                                   |             |                      |       | 682 |
| 0.0075   | 10.0 x 16.5 (18.5) x 17.5            | 3.3                        |   |                         |                        |                                   |             | 752                  |       |     |
| 0.0082   |                                      |                            |   |                         | 60...                  | 64...                             | 62...       | 63...                | 65... | 822 |
| 0.0091   |                                      |                            |   |                         | (500)                  | (450)                             | (600)       | (500)                | (250) | 912 |
| 0.01   |                                      |                            |   |                         |                        |                                   |             |                      |       | 103 |
| <b>Pitch = 22.5 mm <math>\pm</math> 0.4 mm; <math>d_t = 0.80\text{ mm} \pm 0.08\text{ mm}</math></b> |                                      |                            |   |                         | <b>Pitch = 22.5 mm</b> |                                   |             |                      |       |     |
| 0.011  | 7.0 x 16.5 x 26.0                    | 3.0                        |   |                         |                        |                                   |             | 113                  |       |     |
| 0.012  |                                      |                            |   |                         | 60...                  | 64...                             | 62...       | -                    | -     | 123 |
| 0.013  |                                      |                            |   |                         | (200)                  | (250)                             | (550)       |                      |       | 133 |
| 0.015  | 8.5 x 18.0 x 26.0                    | 4.2                        |   |                         |                        |                                   |             | 153                  |       |     |
| 0.016  |                                      |                            |   |                         | 60...                  | 64...                             | 62...       | -                    | -     | 163 |
| 0.018  |                                      |                            |   |                         | (200)                  | (250)                             | (450)       |                      |       | 183 |
| 0.02   | 10.0 x 19.5 x 26.0                   | 5.3                        |   |                         |                        |                                   |             | 203                  |       |     |
| 0.022  |                                      |                            |   |                         | 60...                  | 64...                             | 62...       | -                    | -     | 223 |
| 0.024  |                                      |                            |   |                         | (200)                  | (200)                             | (350)       |                      |       | 243 |
| <b>Pitch = 27.5 mm <math>\pm</math> 0.4 mm; <math>d_t = 0.80\text{ mm} \pm 0.08\text{ mm}</math></b> |                                      |                            |   |                         | <b>Pitch = 27.5 mm</b> |                                   |             |                      |       |     |
| 0.027  | 11.0 x 21.0 x 31.0                   | 8.0                        |   |                         |                        |                                   |             | 273                  |       |     |
| 0.03   |                                      |                            |   |                         | 60...                  | 64...                             |             |                      | 303   |     |
| 0.033  |                                      |                            |   |                         | (100)                  | (125)                             |             |                      | 333   |     |
| 0.036  |                                      |                            |   |                         |                        |                                   |             |                      | 363   |     |
| 0.039  |                                      |                            |   |                         |                        |                                   |             |                      | 393   |     |

### Notes

- (1) Net weight for short lead products only
- SPQ = Standard Packaging Quantity



AC and Pulse Double Metallized Polypropylene  
Film Capacitors MMKP Radial Potted Type

Vishay BCcomponents

| C<br>( $\mu\text{F}$ )   | DIMENSIONS<br>w x h (h') x l<br>(mm) | MASS<br>(g) <sup>(1)</sup> | CATALOG NUMBER BFC2 383 XYYYY AND PACKAGING |                         |                |                            |                      | C-VALUE<br><br>..YYY |
|--|--------------------------------------|----------------------------|---|-------------------------|----------------|----------------------------|----------------------|----------------------|
|  |                                      |                            | LOOSE IN BOX                                |                         | REEL           |                            |                      |                      |
|  |                                      |                            | Leads<br>3.5 $\pm$ 0.3                      | Leads<br>25.0 $\pm$ 2.0 | Original pitch | Pitch = 7.5 mm (bent back) |                      |                      |
|  |                                      |                            | XX<br>(SPQ)                                 | XX<br>(SPQ)             |                | $\varnothing$ 500 mm       | $\varnothing$ 356 mm |                      |
| Pitch = 27.5 mm $\pm$ 0.4 mm; d <sub>t</sub> = 0.80 mm $\pm$ 0.08 mm |                                      |                            | Pitch = 27.5 mm                             |                         |                |                            |                      |                      |
| 0.043<br>0.047<br>0.051  | 13.0 x 23.0 x 31.0                   | 9.7                        | 60...<br>(100)                              | 64...<br>(125)          |                | 433<br>473<br>513          |                      |                      |
| 0.056<br>0.062<br>0.068  | 15.0 x 25.0 x 31.0                   | 12.6                       | 60...<br>(100)                              | 64...<br>(125)          | -              | 563<br>623<br>683          |                      |                      |
| 0.075<br>0.082<br>0.091<br>0.10                                      | 18.0 x 28.0 x 31.0                   | 16.3                       | 60...<br>(100)                              | 64...<br>(100)          |                | 753<br>823<br>913<br>104   |                      |                      |

**Notes**

- (1) Net weight for short lead products only
- SPQ = Standard Packaging Quantity

**SPECIFIC REFERENCE DATA (2500 Vdc)**

| DESCRIPTION  | VALUE                   |                          |
|--|-------------------------|--------------------------|
| Tangent of loss angle:<br>C $\leq$ 0.015 $\mu\text{F}$<br>0.015 $\mu\text{F}$ < C $\leq$ 0.056 $\mu\text{F}$   | at 10 kHz               | at 100 kHz               |
|  | $\leq 5 \times 10^{-4}$ | $\leq 10 \times 10^{-4}$ |
|  | $\leq 5 \times 10^{-4}$ | $\leq 15 \times 10^{-4}$ |
| Rated voltage pulse slope (dU/dt) <sub>R</sub> :<br>C $\leq$ 0.015 $\mu\text{F}$<br>0.015 $\mu\text{F}$ < C $\leq$ 0.043 $\mu\text{F}$<br>0.043 $\mu\text{F}$ < C $\leq$ 0.056 $\mu\text{F}$ | 13 000 V/ $\mu\text{s}$ |                          |
|  | 6000 V/ $\mu\text{s}$   |                          |
|  | 4200 V/ $\mu\text{s}$   |                          |
| R between leads, for C $\leq$ 1 $\mu\text{F}$ at 500 V, 1 min  | > 100 000 M $\Omega$    |                          |
| R between leads and case, 500 V, 1 min   | > 30 000 M $\Omega$     |                          |
| Ionization (AC) voltage (typical value) at 20 pC peak discharge  | > 1000 V                |                          |
| Withstanding (DC) voltage (cut off current 10 mA), rise time 100 V/s   | 3500 V, 1 min           |                          |
| Withstanding (DC) voltage between leads and case   | 2840 V, 1 min           |                          |
| Maximum application temperature  | 105 °C                  |                          |

# MMKP383



Vishay BCcomponents AC and Pulse Double Metallized Polypropylene Film Capacitors MMKP Radial Potted Type

$U_{Rdc} = 2500\text{ V}$ ;  $U_{Rac} = 900\text{ V}$ ;  $U_{p-p} = 2500\text{ V}$ ; C-tol. =  $\pm 5\%$

| C<br>( $\mu\text{F}$ )   | DIMENSIONS<br>w x h x l<br>(mm) | MASS<br>(g) <sup>(1)</sup> | CATALOG NUMBER BFC2 383 XXYYY AND PACKAGING |                            |                |         |
|--|---------------------------------|----------------------------|---|----------------------------|----------------|---------|
|  |                                 |                            | LOOSE IN BOX                                |                            | REEL           | C-VALUE |
|  |                                 |                            | Leads<br>3.5 $\pm$ 0.3 mm                   | Leads<br>25.0 $\pm$ 2.0 mm | H = 18.5 mm    | ..YYY   |
|  |                                 |                            | XX<br>(SPQ)                                 | XX<br>(SPQ)                | XX<br>(SPQ)    |         |
| <b>Pitch = 22.5 mm <math>\pm</math> 0.4 mm; d<sub>t</sub> = 0.80 mm <math>\pm</math> 0.08 mm</b> |                                 |                            |   |                            |                |         |
| 0.001  | 6.0 x 15.5 x 26.0               | 2.4                        | 70...<br>(200)                              | 74...<br>(250)             | 72...<br>(600) | 102     |
| 0.0011   |                                 |                            |   |                            |                | 112     |
| 0.0012   |                                 |                            |   |                            |                | 122     |
| 0.0013   |                                 |                            |   |                            |                | 132     |
| 0.0015   |                                 |                            |   |                            |                | 152     |
| 0.0016   |                                 |                            |   |                            |                | 162     |
| 0.0018   |                                 |                            |   |                            |                | 182     |
| 0.002  |                                 |                            |   |                            |                | 202     |
| 0.0022   |                                 |                            |   |                            |                | 222     |
| 0.0024   |                                 |                            |   |                            |                | 242     |
| 0.0027   |                                 |                            |   |                            |                | 272     |
| 0.003  |                                 |                            |   |                            |                | 302     |
| 0.0033   |                                 |                            |   |                            |                | 332     |
| 0.0036   |                                 |                            |   |                            |                | 362     |
| 0.0039   |                                 |                            |   |                            |                | 392     |
| 0.0043   | 432                             |                            |   |                            |                |         |
| 0.0047   | 472                             |                            |   |                            |                |         |
| 0.0051   | 512                             |                            |   |                            |                |         |
| 0.0056   | 7.0 x 16.5 x 26.0               | 3.0                        | 70...<br>(200)                              | 74...<br>(250)             | 72...<br>(550) | 562     |
| 0.0062   |                                 |                            |   |                            |                | 622     |
| 0.0068   |                                 |                            |   |                            |                | 682     |
| 0.0075   |                                 |                            |   |                            |                | 752     |
| 0.0082   | 8.5 x 18.0 x 26.0               | 4.2                        | 70...<br>(200)                              | 74...<br>(250)             | 72...<br>(450) | 822     |
| 0.0091   |                                 |                            |   |                            |                | 912     |
| 0.01   |                                 |                            |   |                            |                | 103     |
| 0.011  | 10.0 x 19.5 x 26.0              | 5.3                        | 70...<br>(200)                              | 74...<br>(200)             | 72...<br>(350) | 113     |
| 0.012  |                                 |                            |   |                            |                | 123     |
| 0.013  |                                 |                            |   |                            |                | 133     |
| 0.015  |                                 |                            |   |                            |                | 153     |
| <b>Pitch = 27.5 mm <math>\pm</math> 0.4 mm; d<sub>t</sub> = 0.80 mm <math>\pm</math> 0.08 mm</b> |                                 |                            |   |                            |                |         |
| 0.016  | 9.0 x 19.0 x 31.0               | 5.9                        | 70...                                       | 74...                      |                | 163     |
| 0.018  | 11.0 x 21.0 x 31.0              | 8.0                        | 70...<br>(100)                              | 74...<br>(125)             |                | 183     |
| 0.02   |                                 |                            |   |                            |                | 203     |
| 0.022  |                                 |                            |   |                            |                | 223     |
| 0.024  |                                 |                            |   |                            |                | 243     |
| 0.027  | 13.0 x 23.0 x 31.0              | 9.7                        | 70...<br>(100)                              | 74...<br>(125)             |                | 273     |
| 0.03   |                                 |                            |   |                            |                | 303     |
| 0.033  |                                 |                            |   |                            |                | 333     |
| 0.036  | 15.0 x 25.0 x 31.0              | 12.6                       | 70...<br>(100)                              | 74...<br>(125)             |                | 363     |
| 0.039  |                                 |                            |   |                            |                | 393     |
| 0.043  |                                 |                            |   |                            |                | 433     |
| 0.047  |                                 |                            |   |                            |                | 473     |
| 0.051  | 18.0 x 28.0 x 31.0              | 16.3                       | 70...<br>(100)                              | 74...<br>(100)             |                | 513     |
| 0.056  |                                 |                            |   |                            |                | 563     |

**Notes**

<sup>(1)</sup> Net weight for short lead products only

- SPQ = Standard Packaging Quantity



## MOUNTING

### Normal Use

The capacitors are designed for mounting on printed-circuit boards. The capacitors packed in bandoliers are designed for mounting on printed-circuit boards by means of automatic insertion machines.

For detailed tape specifications refer to "Packaging Information" [www.vishay.com/docs?28139](http://www.vishay.com/docs?28139)

### Specific Method of Mounting to Withstand Vibration and Shock

In order to withstand vibration and shock tests, it must be ensured that the stand-off pips are in good contact with the printed-circuit board:

- For original pitch = 15 mm the capacitors shall be mechanically fixed by the leads
- For larger pitches the capacitors shall be mounted in the same way and the body clamped

### Space Requirements on Printed-Circuit Board

The maximum length and width of film capacitors is shown in the drawing:

- Eccentricity as in drawing. The maximum eccentricity is smaller than or equal to the lead diameter of the product concerned
- Product height with seating plane as given by "IEC 60717" as reference:  $h_{max.} \leq h + 0.3 \text{ mm}$

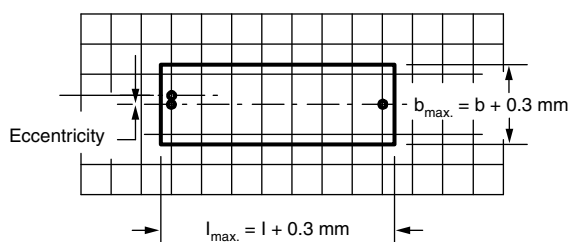

### Storage Temperature

- Storage temperature:  $T_{stg} = -25 \text{ }^{\circ}\text{C}$  to  $+40 \text{ }^{\circ}\text{C}$  with RH maximum 80 % without condensation

### Ratings and Characteristics Reference Conditions

Unless otherwise specified, all electrical values apply to an ambient free temperature of  $23 \text{ }^{\circ}\text{C} \pm 1 \text{ }^{\circ}\text{C}$ , an atmospheric pressure of 86 kPa to 106 kPa and a relative humidity of  $50 \% \pm 2 \%$ .

For reference testing, a conditioning period shall be applied over  $96 \text{ h} \pm 4 \text{ h}$  by heating the products in a circulating air oven at the rated temperature and a relative humidity not exceeding 20 %.

# MMKP383



## Vishay BCcomponents AC and Pulse Double Metallized Polypropylene Film Capacitors MMKP Radial Potted Type

### CHARACTERISTICS

Capacitance as a function of ambient temperature (typical curve)  
(1 kHz)

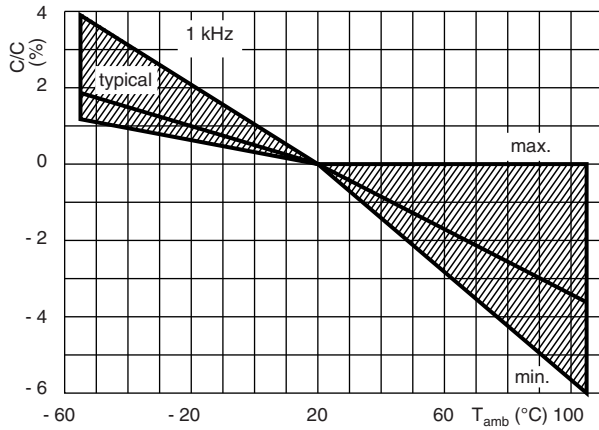

Impedance as a function of frequency (typical curve)

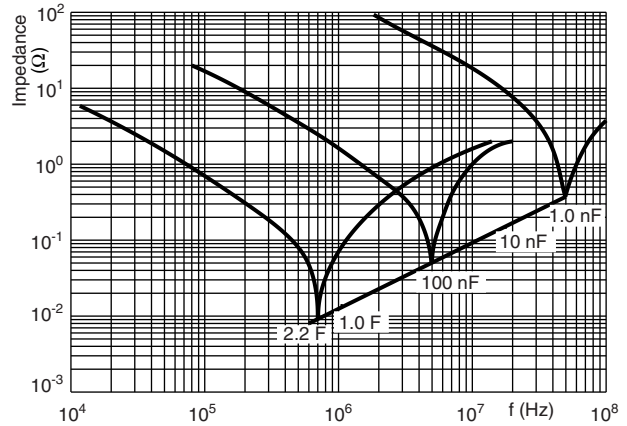

Max. DC and AC voltage as function of temperature

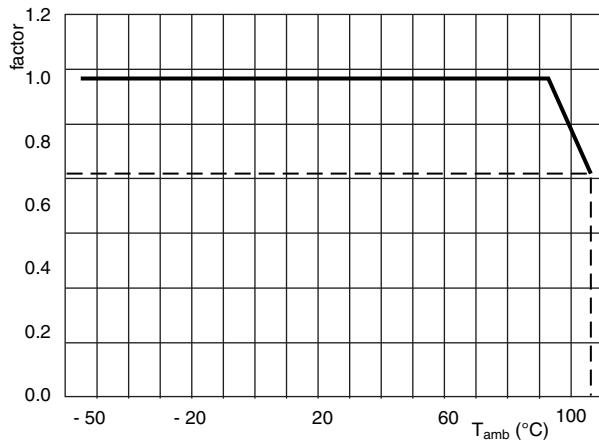

Max. RMS voltage as a function of frequency

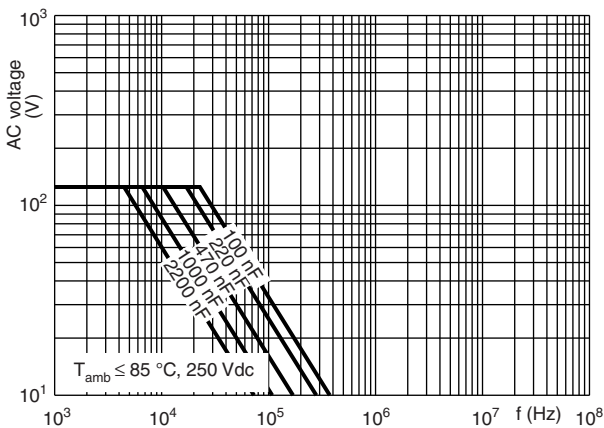

Max. RMS voltage as a function of frequency

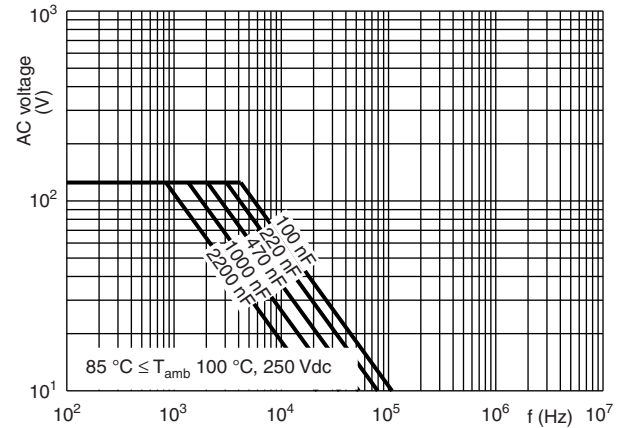





AC and Pulse Double Metallized Polypropylene Film Capacitors MMKP Radial Potted Type

Vishey BCcomponents

Max. RMS voltage as a function of frequency

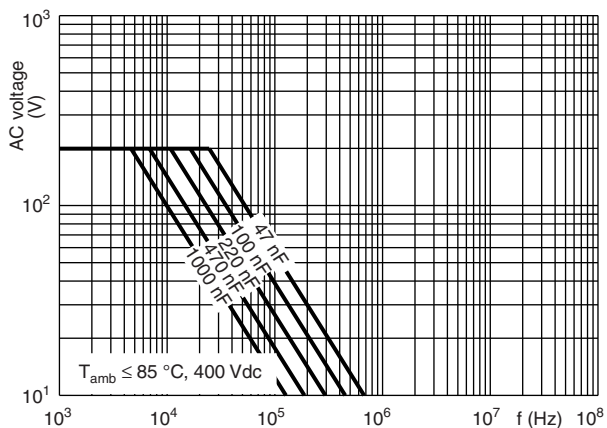

Max. RMS voltage as a function of frequency

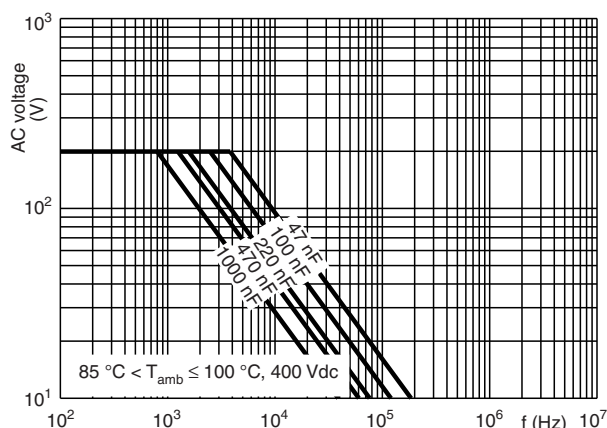

Max. RMS voltage as a function of frequency

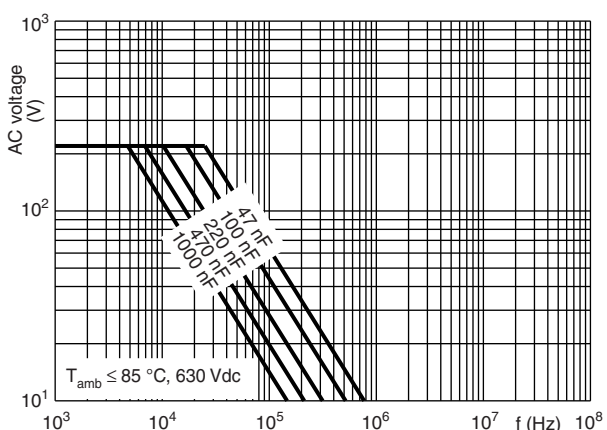

Max. RMS voltage as a function of frequency

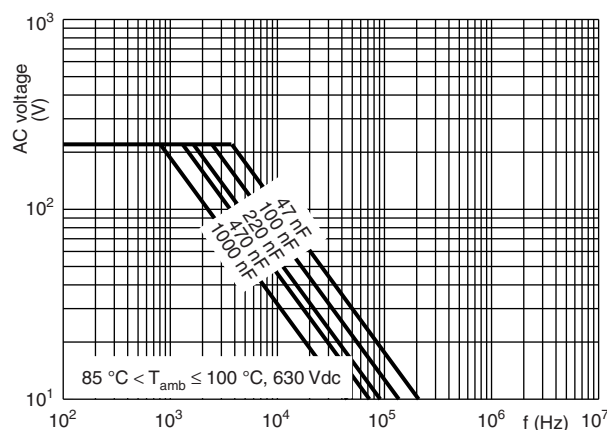

Max. RMS voltage as a function of frequency

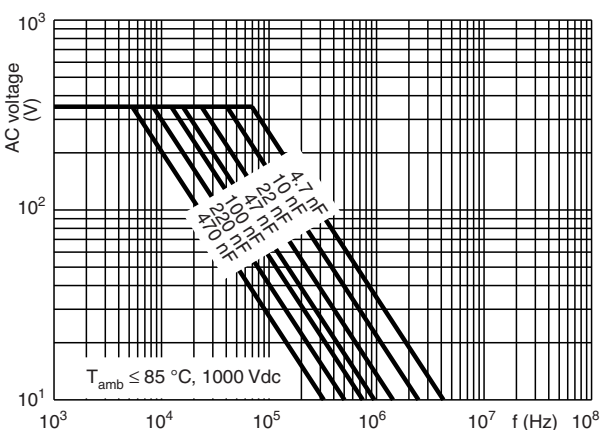

Max. RMS voltage as a function of frequency

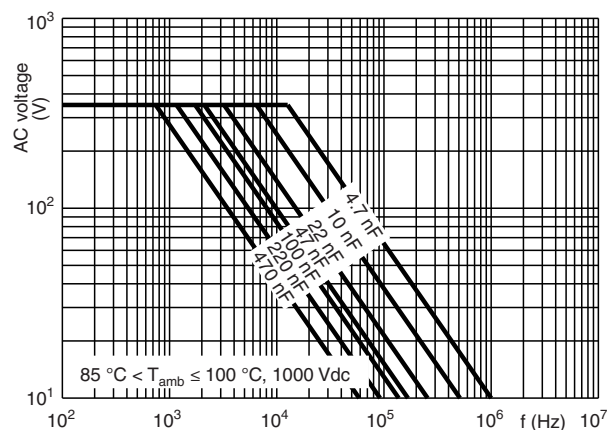

# MMKP383



## Vishay BCcomponents AC and Pulse Double Metallized Polypropylene Film Capacitors MMKP Radial Potted Type

Max. RMS voltage as a function of frequency

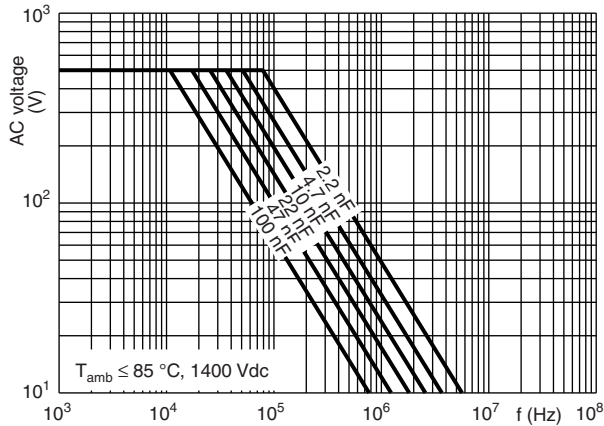

Max. RMS voltage as a function of frequency

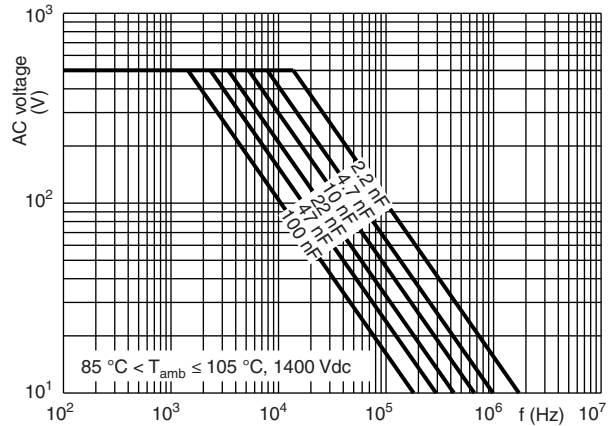

Max. RMS voltage as a function of frequency

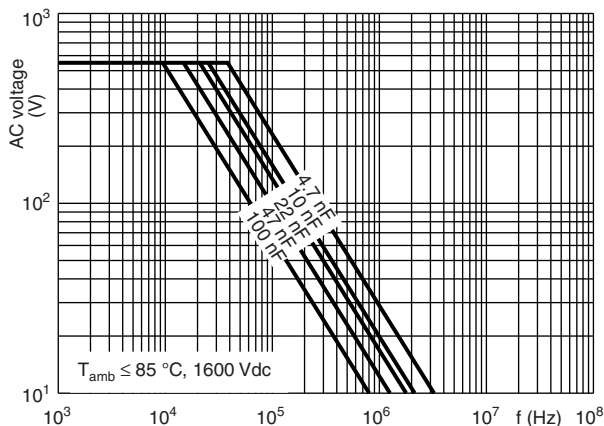

Max. RMS voltage as a function of frequency

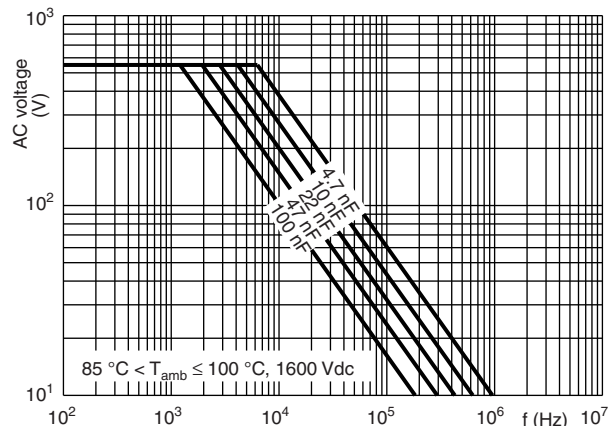

Max. RMS voltage as a function of frequency

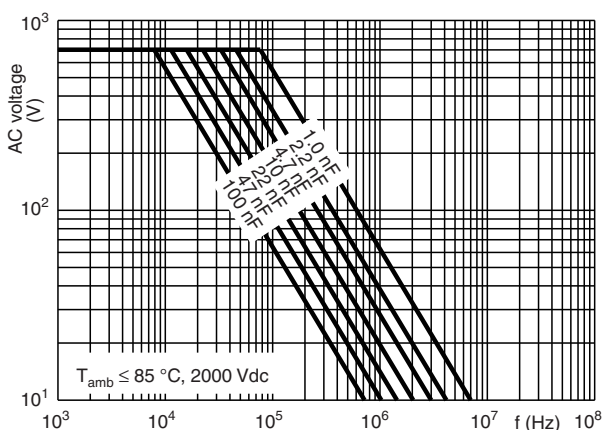

Max. RMS voltage as a function of frequency

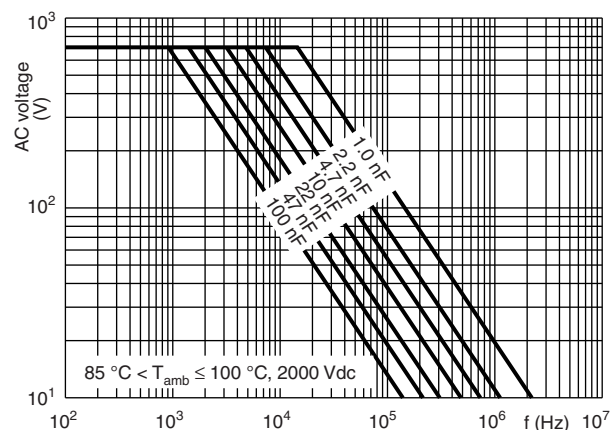



AC and Pulse Double Metallized Polypropylene Film Capacitors MMKP Radial Potted Type

Vishay BCcomponents

Max. RMS voltage as a function of frequency

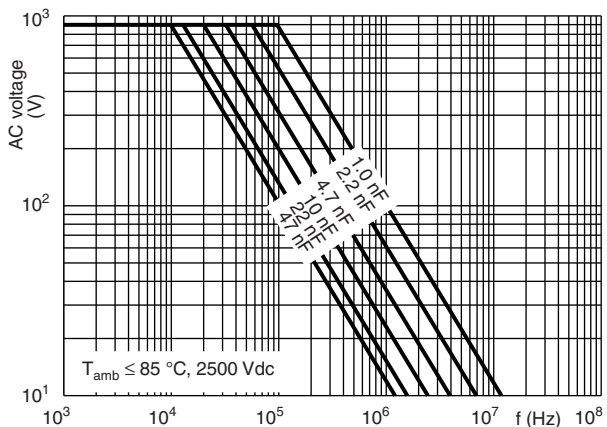

Max. RMS voltage as a function of frequency

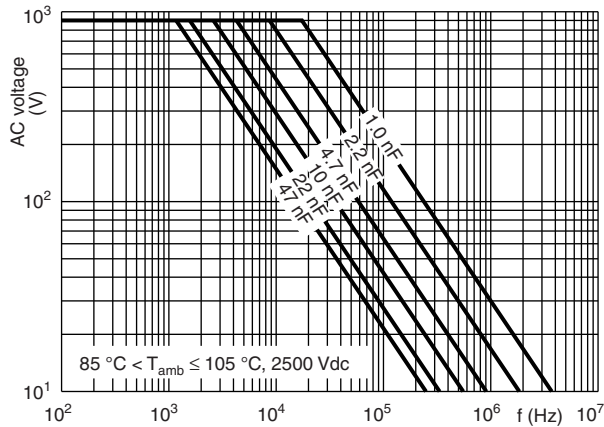

Insulation resistance as a function of ambient temperature

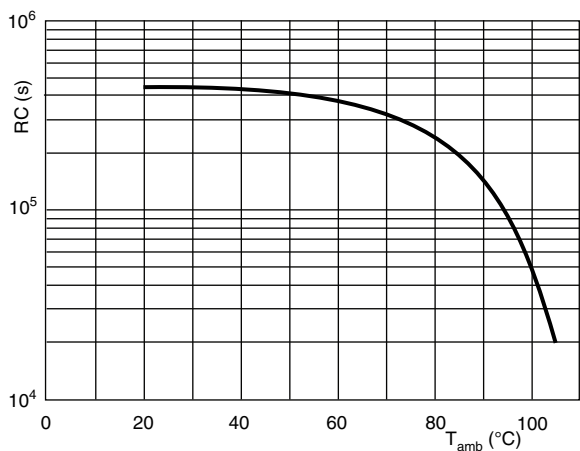

Max. allowed component temperature rise ( $\Delta T$ ) as a function of the ambient temperature ( $T_{amb}$ )

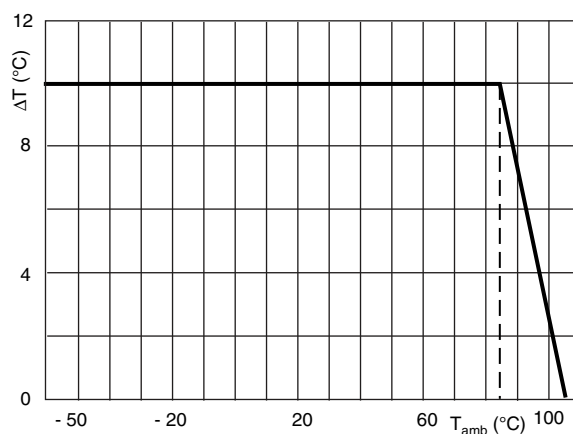

# MMKP383



## Vishay BCcomponents AC and Pulse Double Metallized Polypropylene Film Capacitors MMKP Radial Potted Type

Tangent of loss angle as a function of frequency (typical curve)

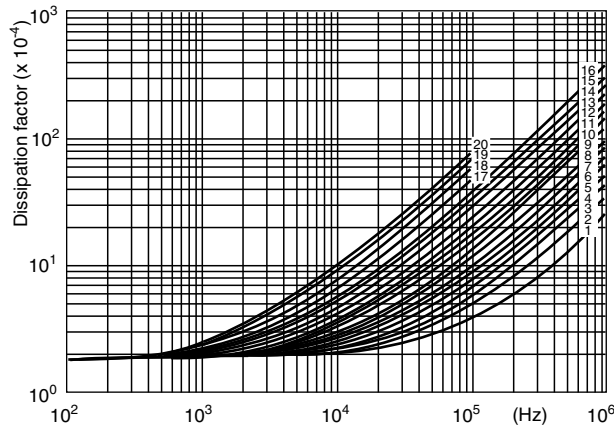

|  |  |   |  |
|--|--|---|--|
| <b>250 V</b><br>C ≤ 0.091 μF, curve 8<br>C ≤ 0.015 μF, curve 9<br>C ≤ 0.022 μF, curve 10<br>C ≤ 0.027 μF, curve 11<br>C ≤ 0.033 μF, curve 12<br>C ≤ 0.056 μF, curve 15<br>C ≤ 0.082 μF, curve 16<br>C ≤ 1.2 μF, curve 18<br>C ≤ 1.61 μF, curve 19<br>C ≤ 2.21 μF, curve 20 | <b>400 V</b><br>C ≤ 0.047 μF, curve 5<br>C ≤ 0.068 μF, curve 6<br>C ≤ 0.1 μF, curve 7<br>C ≤ 0.2 μF, curve 8<br>C ≤ 0.24 μF, curve 12<br>C ≤ 0.36 μF, curve 13<br>C ≤ 0.43 μF, curve 14<br>C ≤ 0.56 μF, curve 16<br>C ≤ 1.1 μF, curve 17 | <b>630 V</b><br>C ≤ 0.033 μF, curve 4<br>C ≤ 0.068 μF, curve 5<br>C ≤ 0.1 μF, curve 6<br>C ≤ 0.15 μF, curve 7<br>C ≤ 0.22 μF, curve 11<br>C ≤ 0.27 μF, curve 12<br>C ≤ 0.47 μF, curve 15<br>C ≤ 0.68 μF, curve 16 | <b>1000 V</b><br>C ≤ 0.01 μF, curve 2<br>C ≤ 0.027 μF, curve 3<br>C ≤ 0.047 μF, curve 4<br>C ≤ 0.062 μF, curve 5<br>C ≤ 0.075 μF, curve 6<br>C ≤ 0.1 μF, curve 7<br>C ≤ 0.15 μF, curve 8<br>C ≤ 0.22 μF, curve 9<br>C ≤ 0.3 μF, curve 10<br>C ≤ 0.39 μF, curve 11<br>C ≤ 0.47 μF, curve 12 |
| <b>140 V</b><br>C ≤ 0.0047 μF, curve 1<br>C ≤ 0.016 μF, curve 2<br>C ≤ 0.033 μF, curve 3<br>C ≤ 0.051 μF, curve 4<br>C ≤ 0.068 μF, curve 5<br>C ≤ 0.082 μF, curve 6<br>C ≤ 0.1 μF, curve 7   | <b>1600 V</b><br>C ≤ 0.0047 μF, curve 3<br>C ≤ 0.0091 μF, curve 4<br>C ≤ 0.068 μF, curve 5<br>C ≤ 0.01 μF, curve 6<br>C ≤ 0.15 μF, curve 7   | <b>2000 V</b><br>C ≤ 0.0047 μF, curve 2<br>C ≤ 0.033 μF, curve 3<br>C ≤ 0.1 μF, curve 4   | <b>2500 V</b><br>C ≤ 0.0047 μF, curve 1<br>C ≤ 0.015 μF, curve 2<br>C ≤ 0.056 μF, curve 3  |

### HEAT CONDUCTIVITY (G) AS A FUNCTION OF (ORIGINAL) PITCH AND CAPACITOR BODY THICKNESS IN mW/°C

| W <sub>max.</sub><br>(mm) | HEAT CONDUCTIVITY (mW/°C) |               |               |
|---------------------------|---------------------------|---------------|---------------|
|                           | PITCH 15 mm               | PITCH 22.5 mm | PITCH 27.5 mm |
| 4.0                       | -                         | -             | -             |
| 5.0                       | 10                        | -             | -             |
| 6.0                       | 11                        | 19            | -             |
| 7.0                       | 12                        | 21            | -             |
| 8.5                       | 16                        | 25            | -             |
| 10.0                      | 18                        | 28            | -             |
| 11.0                      | -                         | -             | 36            |
| 13.0                      | -                         | -             | 42            |
| 15.0                      | -                         | -             | 48            |
| 18.0                      | -                         | -             | 57            |



## POWER DISSIPATION AND MAXIMUM COMPONENT TEMPERATURE RISE

The power dissipation must be limited in order not to exceed the maximum allowed component temperature rise as a function of the free air ambient temperature.

The power dissipation can be calculated according type detail specification "HQN-384-01/101: Technical Information Film Capacitors".

The component temperature rise ( $\Delta T$ ) can be measured (see section "Measuring the component temperature" for more details) or calculated by  $\Delta T = P/G$ :

- $\Delta T$  = Component temperature rise ( $^{\circ}\text{C}$ )
- $P$  = Power dissipation of the component (mW)
- $G$  = Heat conductivity of the component ( $\text{mW}/^{\circ}\text{C}$ )

## MEASURING THE COMPONENT TEMPERATURE

A thermocouple must be attached to the capacitor body as in:

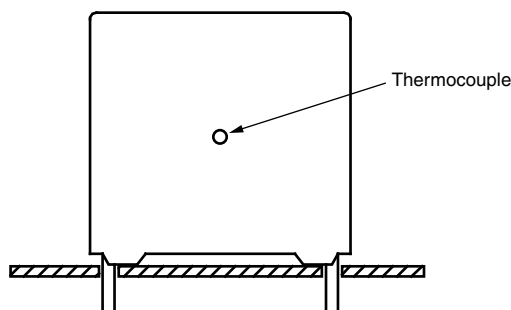

The temperature is measured in unloaded ( $T_{\text{amb}}$ ) and maximum loaded condition ( $T_{\text{C}}$ ).

The temperature rise is given by  $\Delta T = T_{\text{C}} - T_{\text{amb}}$ .

To avoid radiation or convection, the capacitor should be tested in a wind-free box.

## APPLICATION NOTE AND LIMITING CONDITIONS

These capacitors are not suitable for mains applications as across-the-line capacitors without additional protection, as described hereunder. These mains applications are strictly regulated in safety standards and therefore electromagnetic interference suppression capacitors conforming the standards must be used.

To select the capacitor for a certain application, the following conditions must be checked:

1. The peak voltage ( $U_{\text{P}}$ ) shall not be greater than the rated DC voltage ( $U_{\text{Rdc}}$ )
2. The peak-to-peak voltage ( $U_{\text{P-P}}$ ) shall not be greater than  $2\sqrt{2} \times U_{\text{Rac}}$  to avoid the ionisation inception level
3. The voltage pulse slope ( $dU/dt$ ) shall not exceed the rated voltage pulse slope in an RC-circuit at rated voltage and without ringing. If the pulse voltage is lower than the rated DC voltage, the rated voltage pulse slope may be multiplied by  $U_{\text{Rdc}}$  and divided by the applied voltage.

For all other pulses following equation must be fulfilled:

$$2 \times \int_0^T \left( \frac{dU}{dt} \right)^2 \times dt < U_{\text{Rdc}} \times \left( \frac{dU}{dt} \right)_{\text{rated}}$$

$T$  is the pulse duration.

4. The maximum component surface temperature rise must be lower than the limits (see graph max. allowed component temperature rise).
5. Since in circuits used at voltages over 280 V peak-to-peak the risk for an intrinsically active flammability after a capacitor breakdown (short circuit) increases, it is recommended that the power to the component is limited to 100 times the values mentioned in the table: "Heat Conductivity"

# MMKP383



## Vishay BCcomponents AC and Pulse Double Metallized Polypropylene Film Capacitors MMKP Radial Potted Type

6. When using these capacitors as across-the-line capacitor in the input filter for mains applications or as series connected with an impedance to the mains the applicant must guarantee that the following conditions are fulfilled in any case (spikes and surge voltages from the mains included).

### Voltage Conditions for 6 Above

| ALLOWED VOLTAGES                             | $T_{amb} \leq 85\text{ }^{\circ}\text{C}$ | $85\text{ }^{\circ}\text{C} < T_{amb} \leq 105\text{ }^{\circ}\text{C}$ |
|--|---|---|
| Maximum continuous RMS voltage               | $U_{Rac}$                                 | $U_{Rac}$   |
| Maximum temperature RMS-overvoltage (< 24 h) | $1.25 \times U_{Rac}$                     | $1.25 \times U_{Rac}$   |
| Maximum peak voltage ( $V_{O-P}$ ) (< 2 s)   | $1.6 \times U_{Rdc}$                      | $1.1 \times U_{Rdc}$  |

### EXAMPLE

$C = 4\text{ nF} - 1600\text{ V}$  used for the voltage signal shown in next drawing.

$U_{P-P} = 1000\text{ V}$ ;  $U_P = 900\text{ V}$ ;  $T_1 = 12\text{ }\mu\text{s}$ ;  $T_2 = 64\text{ }\mu\text{s}$ ;  $T_3 = 4\text{ }\mu\text{s}$

The ambient temperature is  $80\text{ }^{\circ}\text{C}$ . In case of failure, the oscillation is blocked.

Checking conditions:

1. The peak voltage  $U_P = 900\text{ V}$  is lower than  $1600\text{ Vdc}$
2. The peak-to-peak voltage  $1000\text{ V}$  is lower than  $2\sqrt{2} \times 550\text{ Vac} = 1600\text{ V}$
3. The voltage pulse slope  $(dU/dt) = 1000\text{ V}/4\text{ }\mu\text{s} = 250\text{ V}/\mu\text{s}$   
This is lower than  $8000\text{ V}/\mu\text{s}$  (see specific reference data for each version)
4. The dissipated power is  $35\text{ mW}$  as calculated with fourier terms and typical  $\text{tg}\delta$ .  
The temperature rise for  $W_{max} = 6.0\text{ mm}$  and pitch =  $15\text{ mm}$  will be  $35\text{ mW}/11\text{ mW}/^{\circ}\text{C} = 3.2\text{ }^{\circ}\text{C}$   
This is lower than  $10\text{ }^{\circ}\text{C}$  temperature rise at  $80\text{ }^{\circ}\text{C}$ , according graph.
5. Oscillation is blocked
6. Not applicable

### Voltage Signal

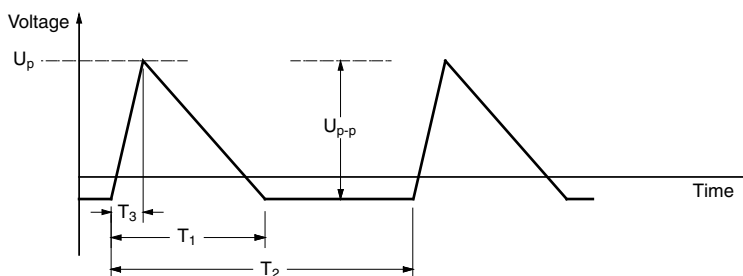



AC and Pulse Double Metallized Polypropylene  
Film Capacitors MMKP Radial Potted Type

Vishay BCcomponents

**INSPECTION REQUIREMENTS**

**General Notes:**

Sub-clause numbers of tests and performance requirements refer to the “Sectional Specification, Publication IEC 60384-17 and Specific Reference Data”.

**Group C Inspection Requirements**

| SUB-CLAUSE NUMBER AND TEST                                | CONDITIONS  | PERFORMANCE REQUIREMENTS   |
|---|---|--|
| <b>SUB-GROUP C1A PART OF SAMPLE OF SUB-GROUP C1</b>       |   |  |
| 4.1 Dimensions (detail)                                   |   | As specified in chapters “General Data” of this specification  |
| 4.3.1 Initial measurements                                | Capacitance<br>Tangent of loss angle:<br>For C ≤ 1 μF at 100 kHz or<br>for C > 1 μF at 10 kHz   |  |
| 4.3 Robustness of terminations                            | Tensile: Load 10 N; 10 s<br>Bending: Load 5 N; 4 x 90°  | No visible damage  |
| 4.4 Resistance to soldering heat                          | Method: 1A<br>Solder bath: 280 °C ± 5 °C<br>Duration: 10 s  |  |
| 4.14 Component solvent resistance                         | Isopropylalcohol at room temperature<br>Method: 2<br>Immersion time: 5 min ± 0.5 min<br>Recovery time: Min. 1 h, max. 2 h   |  |
| 4.4.2 Final measurements                                  | Visual examination<br><br>Capacitance<br><br>Tangent of loss angle  | No visible damage<br>Legible marking<br><br>$ \Delta C/C  \leq 1\%$ of the value measured initially<br><br>Increase of tan δ<br>≤ 0.0005 for: C ≤ 100 nF or<br>≤ 0.001 for: 100 nF < C ≤ 470 nF or<br>≤ 0.0015 for: C > 470 nF<br>Compared to values measured in 4.3.1 |
| <b>SUB-GROUP C1B OTHER PART OF SAMPLE OF SUB-GROUP C1</b> |   |  |
| 4.6.1 Initial measurements                                | Capacitance<br>Tangent of loss angle:<br>For C ≤ 1 μF at 100 kHz or<br>for C > 1 μF at 10 kHz   |  |
| 4.15 Solvent resistance of the marking                    | Isopropylalcohol at room temperature<br>Method: 1<br>Rubbing material: cotton wool  | No visible damage<br>Legible marking   |
| 4.6 Rapid change of temperature                           | Immersion time: 5.0 min ± 0.5 min<br>θA = - 55 °C<br>θB = + 105 °C<br>5 cycles<br>Duration t = 30 min   |  |
| 4.7 Vibration   | Visual examination<br>Mounting: see section “Mounting” for more information<br>Procedure B4<br>Frequency range: 10 Hz to 55 Hz<br>Amplitude: 0.75 mm or<br>Acceleration 98 m/s <sup>2</sup><br>(whichever is less severe)<br>Total duration 6 h | No visible damage  |

# MMKP383



## Vishay BCcomponents AC and Pulse Double Metallized Polypropylene Film Capacitors MMKP Radial Potted Type

| SUB-CLAUSE NUMBER AND TEST   | CONDITIONS   | PERFORMANCE REQUIREMENTS  |
|--|--|---|
| <b>SUB-GROUP C1B OTHER PART OF SAMPLE OF SUB-GROUP C1</b>  |  |   |
| 4.7.2 Final inspection<br>4.9 Shock<br><br>4.9.3 Final measurements  | Visual examination<br>Mounting:<br>See section "Mounting" for more information<br>Pulse shape: Half sine<br>Acceleration: 490 m/s <sup>2</sup><br>Duration of pulse: 11 ms<br><br>Visual examination<br>Capacitance<br>Tangent of loss angle<br><br>Insulation resistance          | No visible damage<br><br>No visible damage<br>$ \Delta C/C  \leq 1\%$ of the value measured in 4.6.1<br>Increase of $\tan \delta$<br>$\leq 0.0005$ for: $C \leq 100$ nF or<br>$\leq 0.001$ for: $100$ nF < $C \leq 470$ nF or<br>$\leq 0.0015$ for: $C > 470$ nF<br>Compared to values measured in 4.6.1<br>As specified in section "Insulation Resistance" of this specification   |
| <b>SUB-GROUP C1 COMBINED SAMPLE OF SPECIMENS OF SUB-GROUPS C1A AND C1B</b>   |  |   |
| 4.10 Climatic sequence<br>4.10.2 Dry heat<br><br>4.10.3 Damp heat cyclic<br>Test Db, first cycle<br>4.10.4 Cold<br><br>4.10.6 Damp heat cyclic<br>Test Db, remaining cycles<br>4.10.6.2 Final measurements | Temperature: + 105 °C<br>Duration: 16 h<br><br>Temperature: - 55 °C<br>Duration: 2 h<br><br>Voltage proof = $U_{Rdc}$ for 1 min within 15 min after removal from testchamber<br>Visual examination<br><br>Capacitance<br><br>Tangent of loss angle<br><br>Insulation resistance    | No breakdown of flash-over<br><br>No visible damage<br>Legible marking<br>For original pitch = 22.5 mm and 27.5 mm:<br>$ \Delta C/C  \leq 3\%$ of the value measured in 4.4.2 or 4.9.3<br>Increase of $\tan \delta$<br>$\leq 0.0005$ for: $C \leq 100$ nF or<br>$\leq 0.001$ for: $100$ nF < $C \leq 470$ nF or<br>$\leq 0.0015$ for: $C > 470$ nF<br>Compared to values measured in 4.3.1 or 4.6.1<br>$\geq 50\%$ of values specified in section "Insulation Resistance" of this specification |
| <b>SUB-GROUP C2</b>  |  |   |
| 4.11 Damp heat steady state<br>4.11.1 Initial measurements<br>4.11.3 Final measurements  | 56 days, 40 °C, 90 % to 95 % RH<br>no load<br>Capacitance<br>Tangent of loss angle at 1 kHz<br>Voltage proof = $U_{Rdc}$ for 1 min within 15 min after removal from testchamber<br>Visual examination<br><br>Capacitance<br><br>Tangent of loss angle<br><br>Insulation resistance | No breakdown of flash-over<br><br>No visible damage<br>Legible marking<br>$ \Delta C/C  \leq 1\%$ of the value measured in 4.11.1.<br>Increase of $\tan \delta$<br>$\leq 0.0005$ for: $C \leq 100$ nF or<br>$\leq 0.001$ for: $100$ nF < $C \leq 470$ nF or<br>$\leq 0.0015$ for: $C \leq 470$ nF<br>Compared to values measured in 4.11.1<br>$\geq 50\%$ of values specified in section "Insulation Resistance" of this specification  |







## **Disclaimer**

ALL PRODUCT, PRODUCT SPECIFICATIONS AND DATA ARE SUBJECT TO CHANGE WITHOUT NOTICE TO IMPROVE RELIABILITY, FUNCTION OR DESIGN OR OTHERWISE.

Vishay Intertechnology, Inc., its affiliates, agents, and employees, and all persons acting on its or their behalf (collectively, "Vishay"), disclaim any and all liability for any errors, inaccuracies or incompleteness contained in any datasheet or in any other disclosure relating to any product.

Vishay makes no warranty, representation or guarantee regarding the suitability of the products for any particular purpose or the continuing production of any product. To the maximum extent permitted by applicable law, Vishay disclaims (i) any and all liability arising out of the application or use of any product, (ii) any and all liability, including without limitation special, consequential or incidental damages, and (iii) any and all implied warranties, including warranties of fitness for particular purpose, non-infringement and merchantability.

Statements regarding the suitability of products for certain types of applications are based on Vishay's knowledge of typical requirements that are often placed on Vishay products in generic applications. Such statements are not binding statements about the suitability of products for a particular application. It is the customer's responsibility to validate that a particular product with the properties described in the product specification is suitable for use in a particular application. Parameters provided in datasheets and / or specifications may vary in different applications and performance may vary over time. All operating parameters, including typical parameters, must be validated for each customer application by the customer's technical experts. Product specifications do not expand or otherwise modify Vishay's terms and conditions of purchase, including but not limited to the warranty expressed therein.

Except as expressly indicated in writing, Vishay products are not designed for use in medical, life-saving, or life-sustaining applications or for any other application in which the failure of the Vishay product could result in personal injury or death. Customers using or selling Vishay products not expressly indicated for use in such applications do so at their own risk. Please contact authorized Vishay personnel to obtain written terms and conditions regarding products designed for such applications.

No license, express or implied, by estoppel or otherwise, to any intellectual property rights is granted by this document or by any conduct of Vishay. Product names and markings noted herein may be trademarks of their respective owners.