

THIS DOCUMENT IS THE PROPERTY OF
KEYSTONE ELECTRONICS CORP. AND
SHALL NOT BE REPRODUCED, DISTRIBUTED
OR USED AS A BASIS FOR MANUFACTURE
WITHOUT PRIOR WRITTEN PERMISSION
FROM KEYSTONE ELECTRONICS CORP.

ACTUAL SIZE

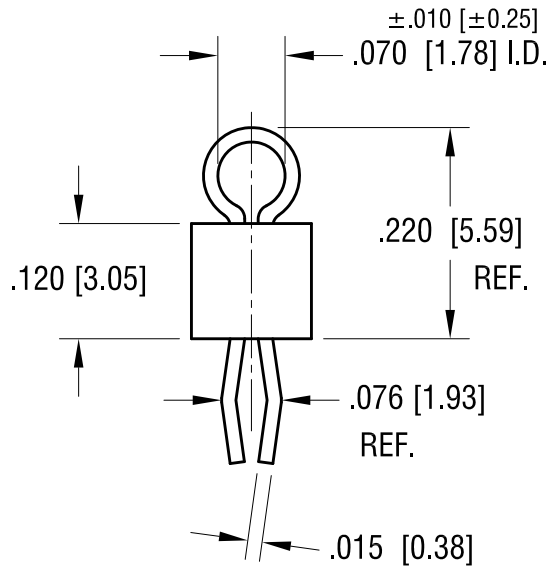

MTG. DETAIL

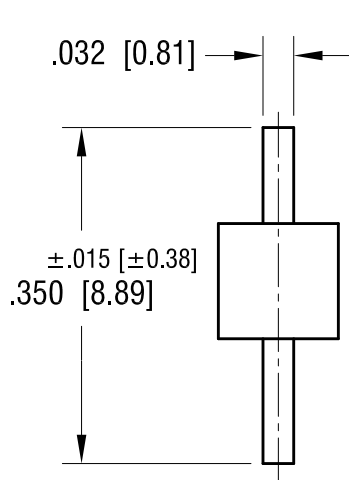
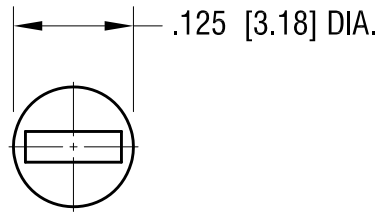
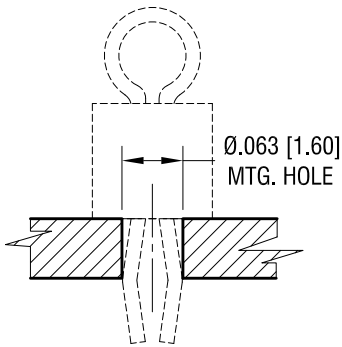

PART NO.	BASE COLOR
5120	BROWN
5121	GREEN
5122	BLUE
5123	GREY
5124	PURPLE

NOTES:

1. TERMINAL:
MAT'L - PHOSPHOR BRONZE WIRE
2. BASE:
MAT'L - HEAT RESISTANT NYLON 46

DATE	DESCRIPTION	REV.
12.30.13	CHANGE AS PER ECN 13-122	C
1.31.13	CHANGE AS PER ECN 13-013	B
1.29.13	CHANGE AS PER ECN 13-008	A

KEYSTONE ELECTRONICS CORP.			
www.keyelco.com • ASTORIA, N.Y. 11105-2017 • Tel (718) 956-8900			
PART NAME			
PC TEST POINT - COMPACT			
MATERIAL			
AS NOTED			
FINISH		DRN BY	DATE
SILVER PLATE		NT	4.22.08
		APP'D	SCALE
		LN	5X
TOLERANCES	INCH [MM]	CODE	DWG NO.
DECIMAL	± .005 [± 0.13]	C	5120-5124
ANGULAR	± 1°		
UNLESS OTHERWISE SPECIFIED			

Mouser Electronics

Authorized Distributor

Click to View Pricing, Inventory, Delivery & Lifecycle Information:

[Keystone Electronics:](#)

[5122](#)