

LOC	DIST	REVISIONS			
P	LTR	DESCRIPTION	DATE	DWN	APVD
	A	ECO-05-9575	27SEP05	MB	MS
	A1	REVISED PER ECO-10-000444	19JAN10	KK	HMR

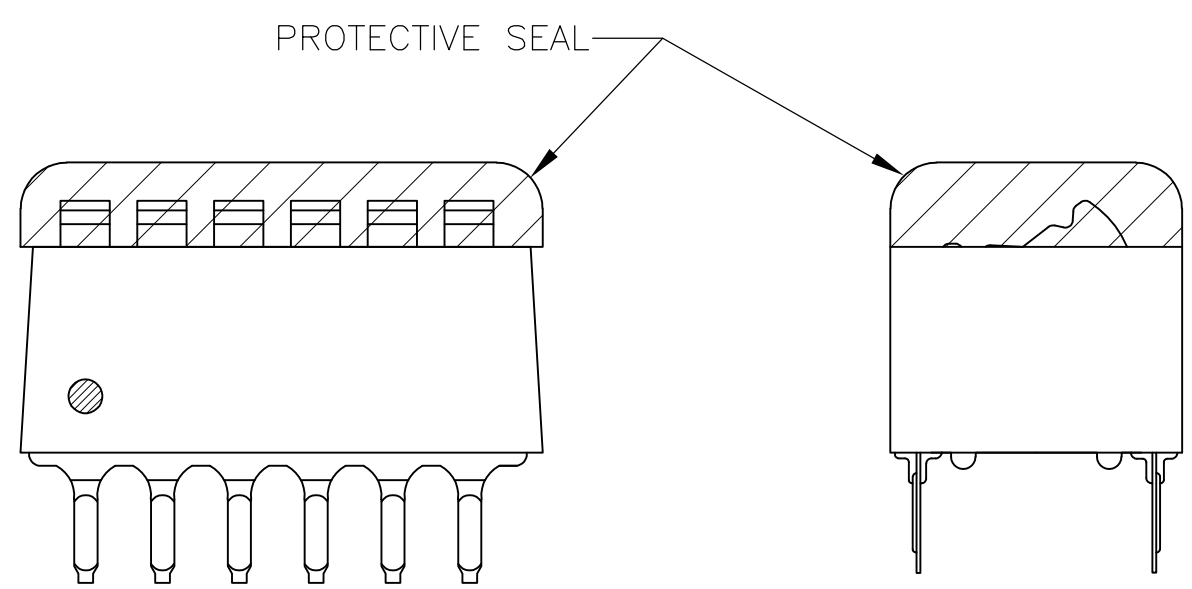
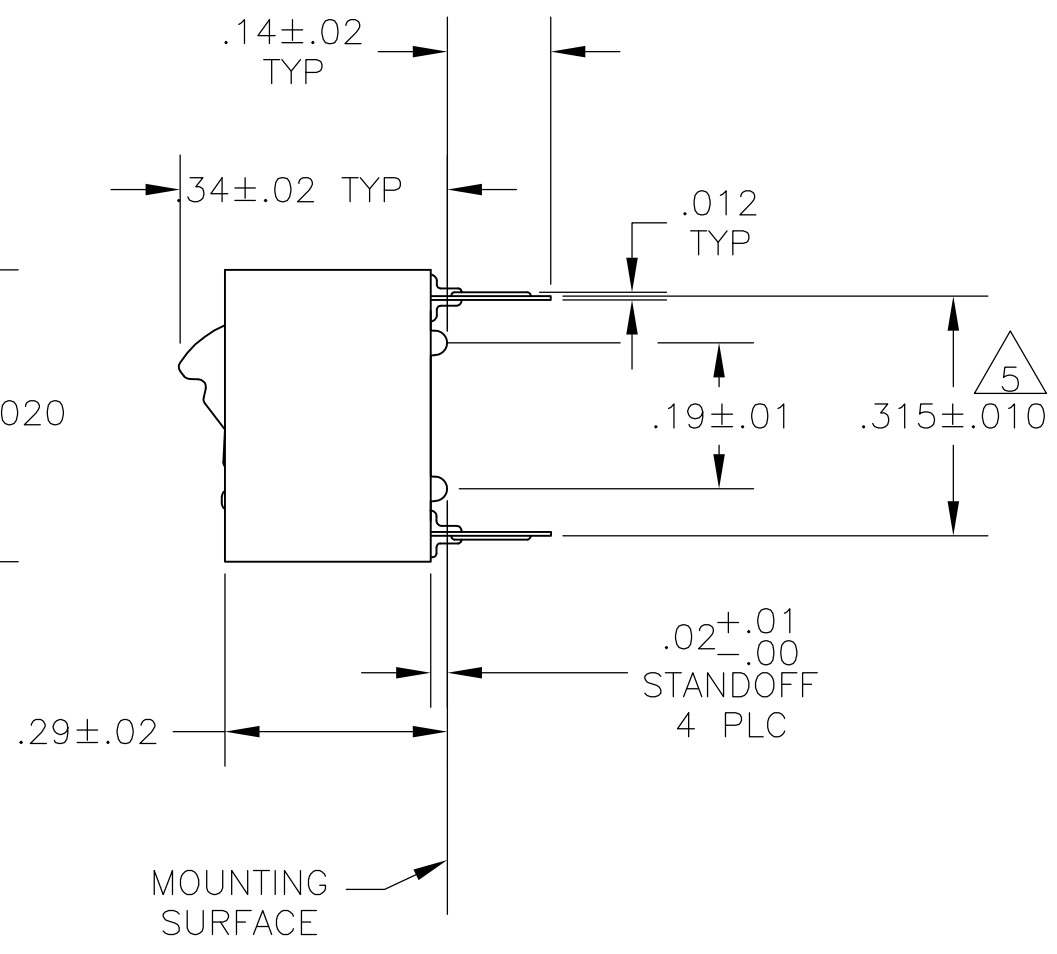
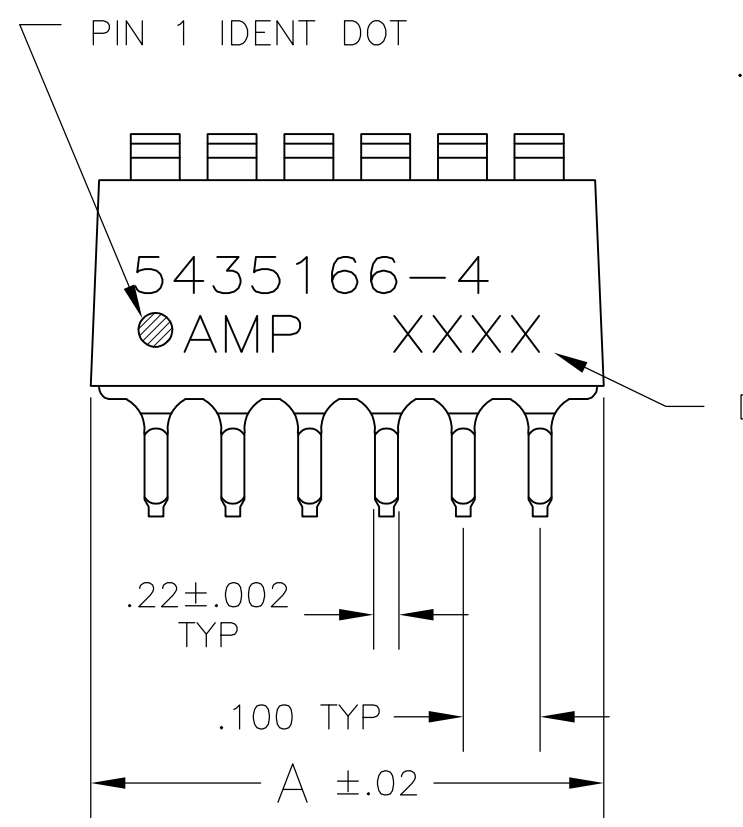
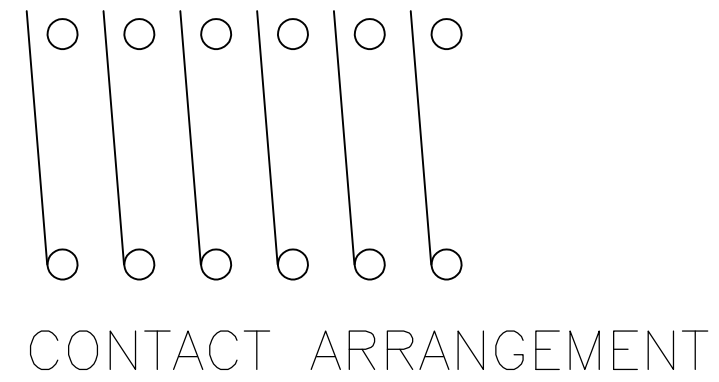
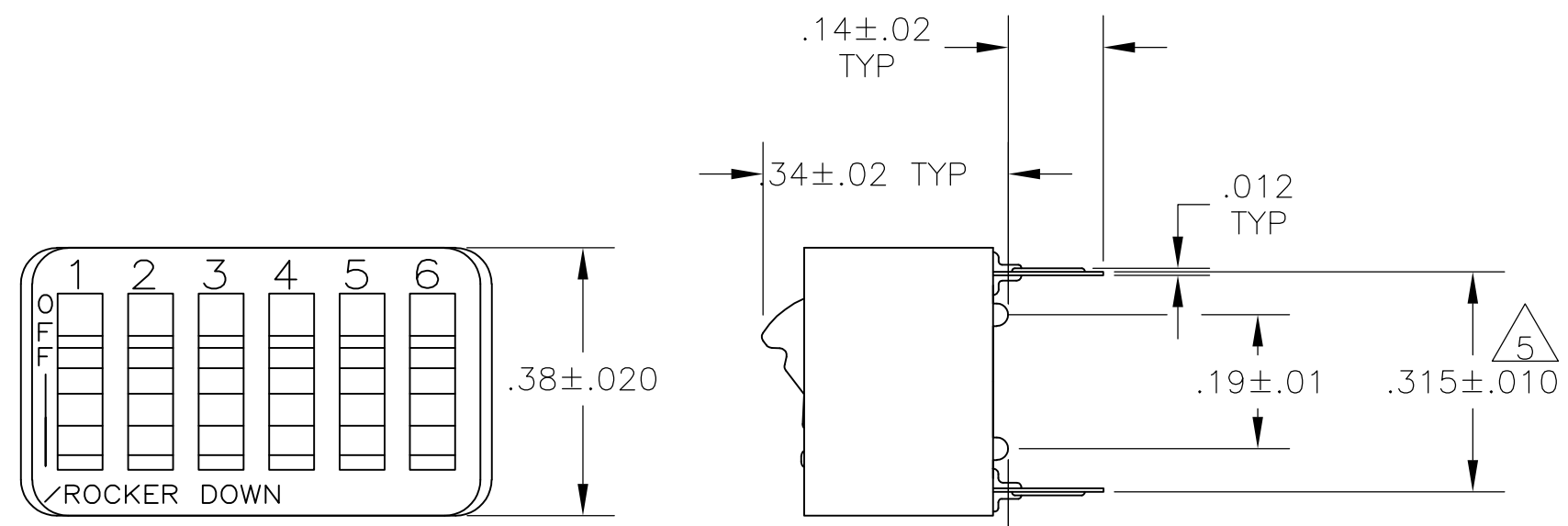

FIG 1

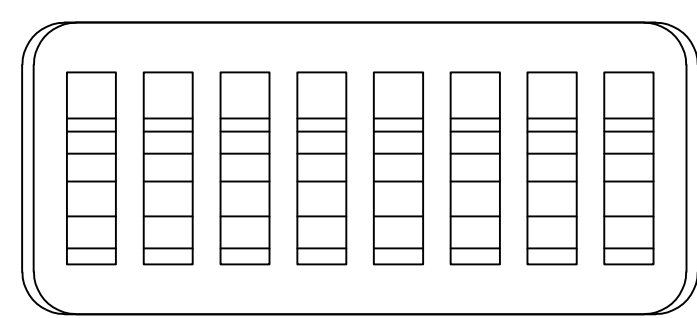

FIG 2

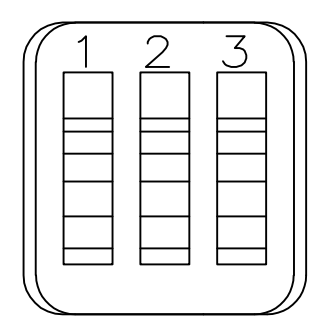

FIG 7

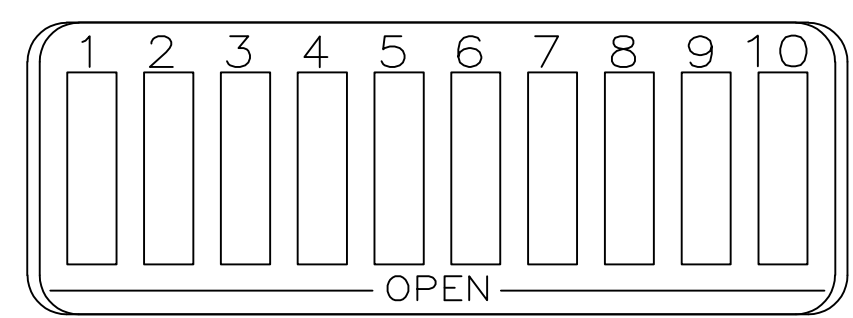

FIG 8

- FOR ADDITIONAL SPECIFICATIONS SEE AMP PRODUCT SPEC 108-7519.
- SWITCH SHOWN IN OPEN POSITION.
- ALL CHARACTERS AND ROCKERS ARE WHITE, HOUSING IS BLACK.
- STAMPING WILL VARY ON 2 AND 3 POSITION SIDES DUE TO SPACE RESTRICTIONS
- $\triangle 5$.315 DIMENSION APPLIES AT TERMINAL TIPS. TERMINALS ARE .300 +.010 AT MOUNTING SURFACE. -.000
- $\triangle 6$ STRIPPABLE TRANSPARENT SEAL, SEE FIG 1.
- ALL MATERIALS AND FINISHES SHALL COMPLY WITH EU DIRECTIVE 2002 /95/EC OF 27JAN2003 (ROHS).
- $\triangle 8$ HOUSING AND ROCKERS-POLYESTER CONTACTS AND SOLDER LEADS-COPPER ALLOY
- $\triangle 9$ CONTACTS-GOLD OVER NICKEL SOLDER LEADS-TIN OVER NICKEL
- $\triangle 10$ OBSOLETE PARTS: OBSOLETE CIS STREAMLINING PER D.RENAUD/D.SINISI

$\triangle 10$ OBSOLETE	FIG 8	$\triangle 6$	1.08	10	7-5435166-4
			1.08	10	5-5435166-5
$\triangle 10$ OBSOLETE	AS SHOWN	$\triangle 6$.88	8	5-5435166-3
			.78	7	5-5435166-2
			.68	6	5-5435166-1
			.58	5	5-5435166-0
$\triangle 10$ OBSOLETE	FIG 7	---	.48	4	4-5435166-9
	FIG 2		---	.88	8
$\triangle 10$ OBSOLETE	AS SHOWN	---	1.08	10	5435166-7
			.88	8	5435166-5
			.68	6	5435166-4
			.48	4	5435166-2
			.78	7	5435166-1
TOP MARKING		PROTECTIVE SEAL	A	NO OF POSN	PART NO

THIS DRAWING IS A CONTROLLED DOCUMENT.		DWN BSV	10JAN2005	Tyco Electronics Corporation Harrisburg, PA 17105-3608	
DIMENSIONS: INCHES	TOLERANCES UNLESS OTHERWISE SPECIFIED:	CHK -	APVD -	NAME	
	0 PLC ± -	PRODUCT SPEC	APPLICATION SPEC	SWITCH ASSY, DIP, TYPE C, 7000 SERIES, SPST, STANDARD	
	1 PLC ± -	WEIGHT	SCALE	CAGE CODE	DRAWING NO
	2 PLC ± -		A2	00779	C=5435166
	3 PLC ± .005	CUSTOMER DRAWING	SCALE	SHEET	REV
	4 PLC ± -		4:1	1 of 1	A1
	ANGLES ± -				
MATERIAL $\triangle 8$	FINISH $\triangle 9$				

Mouser Electronics

Authorized Distributor

Click to View Pricing, Inventory, Delivery & Lifecycle Information:

[TE Connectivity:](#)

[5435166-5](#)