

bq24630 Standalone Synchronous Switched-Mode Lithium Phosphate Battery Charger With System Power Selector and Low I_q

1 Features

- 300-kHz NMOS-NMOS Synchronous Buck Converter
- Stand-Alone Charger Specifically for Lithium Phosphate
- 5-V–28-V VCC Input Operating Range, Supports 1–7 Battery Cells
- High-Accuracy Voltage and Current Regulation
 - $\pm 0.5\%$ Charge Voltage Accuracy
 - $\pm 3\%$ Charge Current Accuracy
 - $\pm 3\%$ Adapter Current Accuracy
- Integration
 - Automatic System Power Selection From Adapter or Battery
 - Internal Loop Compensation
 - Internal Soft Start
 - Dynamic Power Management (DPM)
- Safety Protection
 - Input Overvoltage Protection
 - Battery Thermistor Sense Suspend Charge at Hot/Cold and Automatically $I_{CHARGE}/8$ at Hot/Cold or Warm/Cool
 - Battery Detection
 - Reverse Protection Input FET
 - Programmable Safety Timer
 - Charge Overcurrent Protection
 - Battery Short Protection
 - Battery Overvoltage Protection
 - Thermal Shutdown
- Status Outputs
 - Adapter Present
 - Charger Operation Status
- Charge Enable Pin
- 6-V Gate Drive for Synchronous Buck Converter
- 30-ns Driver Dead Time and 99.95% Max. Effective Duty Cycle
- 24-Pin 4-mm x 4-mm QFN Package
- Energy Star Low Quiescent Current I_q
 - $< 15\text{-}\mu\text{A}$ Off-State Battery Discharge Current
 - $< 1.5\text{-mA}$ Off-State Input Quiescent Current

2 Applications

- Power Tool and Portable Equipment
- Personal Digital Assistants
- Handheld Terminals
- Industrial and Medical Equipment
- Netbook, Mobile Internet Device, and Ultra-Mobile PC

3 Description

The bq24630 is a highly integrated lithium phosphate switched-mode battery charge controller. The device offers a constant-frequency synchronous switching PWM controller with high-accuracy charge current and voltage regulation, charge preconditioning, termination, adapter current regulation, and charge status monitoring.

The bq24630 charges the battery in three phases: preconditioning, constant current, and constant voltage. Charge is terminated when the current reaches a minimum user-selectable level. A programmable charge timer provides a safety backup. The bq24630 automatically restarts the charge cycle if the battery voltage falls below an internal threshold and enters a low quiescent current sleep mode when the input voltage falls below the battery voltage.

Device Information⁽¹⁾

PART NUMBER	PACKAGE	BODY SIZE (NOM)
bq24630	VQFN (24)	4.00 mm x 4.00 mm

(1) For all available packages, see the orderable addendum at the end of the data sheet.

Simplified Schematic

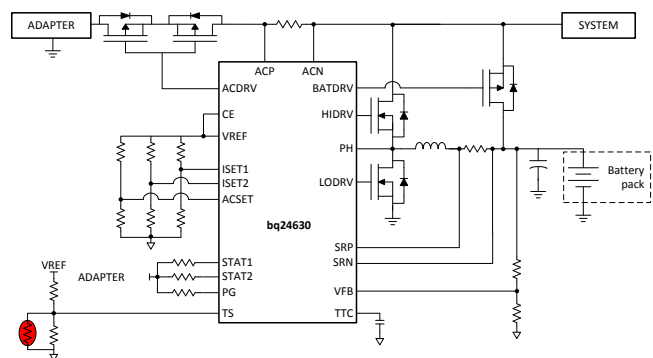

Table of Contents

1 Features	1	8.4 Device Functional Modes.....	24
2 Applications	1	9 Application and Implementation	25
3 Description	1	9.1 Application Information.....	25
4 Revision History	2	9.2 Typical Application	25
5 Device Comparison Table	3	10 Power Supply Recommendations	30
6 Pin Configuration and Functions	3	11 Layout	30
7 Specifications	4	11.1 Layout Guidelines	30
7.1 Absolute Maximum Ratings	4	11.2 Layout Example	31
7.2 ESD Ratings	5	12 Device and Documentation Support	32
7.3 Recommended Operating Conditions.....	5	12.1 Device Support.....	32
7.4 Thermal Information	5	12.2 Documentation Support	32
7.5 Electrical Characteristics.....	5	12.3 Community Resources.....	32
7.6 Typical Characteristics.....	10	12.4 Trademarks	32
8 Detailed Description	13	12.5 Electrostatic Discharge Caution.....	32
8.1 Overview	13	12.6 Glossary	32
8.2 Functional Block Diagram	14	13 Mechanical, Packaging, and Orderable Information	32
8.3 Feature Description.....	15		

4 Revision History

Changes from Revision A (October 2011) to Revision B

Page

- Added *ESD Ratings* table, *Feature Description* section, *Device Functional Modes*, *Application and Implementation* section, *Power Supply Recommendations* section, *Layout* section, *Device and Documentation Support* section, and *Mechanical, Packaging, and Orderable Information* section
- 1**
- Added text, equations and illustrations from Inductor Selection to PCB Layout
- 26**

Changes from Original (January 2010) to Revision A

Page

- Changed descriptions for PH and BTST pins.....
- 4**
- Changed [Equation 1](#) From: R1/R2 To: R2/R1.....
- 15**
- Changed [Equation 1](#)
- 15**
- Changed [Equation 15](#)
- 26**

5 Device Comparison Table

	bq24620	bq24630
Cell chemistry	Lithium phosphate	Lithium phosphate
Number of cells in series (minimum to maximum, 4.2 V/cell)	1 to 7	1 to 7
Charge voltage (minimum to maximum) (V)	1.8 to 26	1.8 to 26
Input voltage range (minimum to maximum) (V)	5 to 28	5 to 28
Input overvoltage (V)	32	32
Maximum battery charging current (A)	10	10
Switching frequency (kHz)	300	300
JEITA charging temperature profile	No	No
DPM	No	I _{IN} DPM

6 Pin Configuration and Functions

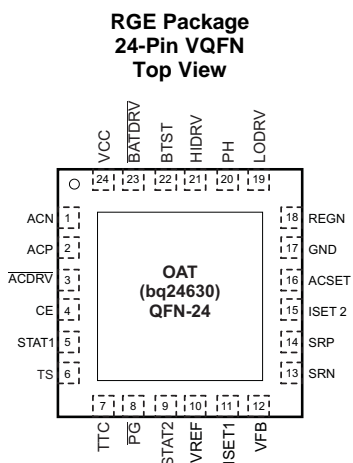

Pin Functions

PIN		I/O	DESCRIPTION
NAME	NO.		
ACDRV	3	O	AC adapter to system MOSFET driver output. Connect through a 1-kΩ resistor to the gate of the ACFET P-channel power MOSFET and the reverse conduction blocking P-channel power MOSFET. The internal gate drive is asymmetrical, allowing a quick turnoff and slow turnon, in addition to the internal break-before-make logic with respect to BATDRV. If needed, an optional capacitor from gate to source of the ACFET is used to slow down the ON and OFF times.
ACN	1	I	Adapter-current sense resistor, negative input. A 0.1-μF ceramic capacitor is placed from ACN to ACP to provide differential-mode filtering. An optional 0.1-μF ceramic capacitor is placed from the ACN pin to GND for common-mode filtering.
ACP	2	I	Adapter-current sense resistor, positive input. A 0.1-μF ceramic capacitor is placed from ACN to ACP to provide differential-mode filtering. A 0.1-μF ceramic capacitor is placed from the ACP pin to GND for common-mode filtering.
ACSET	16	I	Adapter-current set input. The voltage of ACSET pin programs the input current regulation set-point during dynamic power management (DPM).
BATDRV	23	O	Battery-to-system MOSFET-driver output. Gate drive for the battery-to-system load BAT PMOS power FET to isolate the system from the battery to prevent current flow from the system to the battery, while allowing a low-impedance path from battery to system. Connect this pin through a 1-kΩ resistor to the gate of the input BAT P-channel MOSFET. Connect the source of the FET to the system load voltage node. Connect the drain of the FET to the battery pack positive terminal. The internal gate drive is asymmetrical to allow a quick turnoff and slow turnon, in addition to the internal break-before-make logic with respect to ACDRV. If needed, an optional capacitor from gate to source of the BATFET is used to slow down the ON and OFF times.
BTST	22	–	PWM high-side driver positive supply. Connect the 0.1-μF bootstrap capacitor from PH to BTST, and a bootstrap Schottky diode from REGN to BTST.
CE	4	I	Charge-enable active-HIGH logic input. HI enables charge. LO disables charge. It has an internal 1-MΩ pulldown resistor.
GND	17	–	Low-current sensitive analog/digital ground. On PCB layout, connect with the thermal pad underneath the IC.
HIDRV	21	O	PWM high-side driver output. Connect to the gate of the high-side power MOSFET with a short trace.

Pin Functions (continued)

PIN		I/O	DESCRIPTION
NAME	NO.		
ISET1	11	I	Fast-charge current-set input. The voltage of ISET1 pin programs the fast-charge current-regulation set point.
ISET2	15	I	Termination-current set input. The voltage of ISET2 pin programs termination current trigger point.
LODRV	19	O	PWM low-side driver output. Connect to the gate of the low-side power MOSFET with a short trace.
$\overline{\text{PG}}$	8	O	Open-drain power-good status output. Active-LOW when IC has a valid VCC (not in UVLO or ACOV or SLEEP mode). Active-HIGH when IC has an invalid VCC. $\overline{\text{PG}}$ can be used to drive an LED or communicate with a host processor.
PH	20	–	PWM high-side driver negative supply. Connect to the phase-switching node (junction of the low-side power MOSFET drain, high-side power MOSFET source, and output inductor).
REGN	18	O	PWM low-side driver positive 6-V supply output. Connect a 1- μF ceramic capacitor from REGN to the GND pin, close to the IC. Use for low-side driver and high-side driver bootstrap voltage by connecting a small-signal Schottky diode from REGN to BTST.
SRN	13	I	Charge-current sense resistor, negative input. A 0.1- μF ceramic capacitor is placed from SRN to SRP to provide differential-mode filtering. An optional 0.1- μF ceramic capacitor is placed from the SRN pin to GND for common-mode filtering.
SRP	14	I	Charge-current sense resistor, positive input. A 0.1- μF ceramic capacitor is placed from SRN to SRP to provide differential-mode filtering. A 0.1- μF ceramic capacitor is placed from the SRP pin to GND for common-mode filtering.
STAT1	5	–	Open-drain charge-status pin to indicate various charger operations.
STAT2	9	–	Open-drain charge-status pin to indicate various charger operations.
Thermal pad	—	–	Exposed pad beneath the IC. Always solder the thermal pad to the board, and have vias on the thermal pad plane star-connecting to GND and ground plane for high-current power converter. It also serves as a thermal pad to dissipate the heat.
TS	6	I	Temperature qualification voltage input for battery pack negative-temperature-coefficient thermistor. Program the hot and cold temperature window with a resistor divider from VREF to TS to GND.
TTC	7	I	SafetyTimer and termination control. Connect a capacitor from this node to GND to set the timer. When this input is LOW, the timer and termination are disabled. When this input is HIGH, the timer is disabled but termination is allowed.
VCC	24	–	IC power positive supply. Connect through a 10- Ω resistor to the common-source (diode-OR) point: source of high-side P-channel MOSFET and source of reverse-blocking P-channel power MOSFET. Place a 1- μF ceramic capacitor from VCC to the GND pin close to the IC.
VFB	12	O	Output-voltage analog feedback adjustment. Connect the output of a resistive voltage divider from the battery terminals to this node to adjust the output battery-regulation voltage.
VREF	10	O	3.3-V regulated voltage output. Place a 1- μF ceramic capacitor from VREF to the GND pin close to the IC. This voltage could be used for programming of voltage and current regulation and for programming the TS threshold.

7 Specifications

7.1 Absolute Maximum Ratings

over operating free-air temperature range (unless otherwise noted) ⁽¹⁾ ⁽²⁾ ⁽³⁾

		MIN	MAX	UNIT
Voltage range	VCC, ACP, ACN, SRP, SRN, $\overline{\text{BATDRV}}$, $\overline{\text{ACDRV}}$, CE, STAT1, STAT2, $\overline{\text{PG}}$	–0.3	33	V
	PH	–2	36	V
	VFB	–0.3	16	V
	REGN, LODRV, ACSET, TS, TTC	–0.3	7	V
	BTST, HIDRV with respect to GND	–0.3	39	V
	VREF, ISET1, ISET2	–0.3	3.6	V
Maximum difference voltage	ACP–ACN, SRP–SRN	–0.5	0.5	V
Junction temperature range, T_J		–40	155	°C
Storage temperature range, T_{stg}		–55	155	°C

- (1) Stresses beyond those listed under *Absolute Maximum Ratings* may cause permanent damage to the device. These are stress ratings only, and functional operation of the device at these or any other conditions beyond those indicated under *Recommended Operating Conditions* is not implied. Exposure to absolute-maximum-rated conditions for extended periods may affect device reliability.
- (2) All voltages are with respect to GND if not specified. Currents are positive into, negative out of the specified terminal. Consult Packaging Section of the data book for thermal limitations and considerations of packages.
- (3) Must have a series resistor between battery pack to VFB if Battery Pack voltage is expected to be greater than 16 V. Usually, the resistor divider top resistor takes care of this.

7.2 ESD Ratings

		VALUE	UNIT
$V_{(ESD)}$ Electrostatic discharge	Human-body model (HBM), per ANSI/ESDA/JEDEC JS-001 ⁽¹⁾	±2000	V
	Charged-device model (CDM), per JEDEC specification JESD22-C101 ⁽²⁾	±500	

(1) JEDEC document JEP155 states that 500-V HBM allows safe manufacturing with a standard ESD control process.

(2) JEDEC document JEP157 states that 250-V CDM allows safe manufacturing with a standard ESD control process.

7.3 Recommended Operating Conditions

		MIN	NOM	MAX	UNIT
Voltage range	V_{CC} , ACP, ACN, SRP, SRN, BATDRV, ACDRV, CE, STAT1, STAT2, PG	-0.3		28	V
	PH	-2		30	V
	VFB	-0.3		14	V
	REGN, LODRV, ACSET, TS, TTC	-0.3		6.5	V
	BTST, HIDRV with respect to GND	-0.3		34	V
	ISET1, ISET2	-0.3		3.3	V
	VREF			3.3	V
Maximum difference voltage	ACP-ACN, SRP-SRN	-0.2		0.2	V
T_J Junction temperature range		0		125	°C

7.4 Thermal Information

THERMAL METRIC ⁽¹⁾		bq24630		UNIT
		RGE (VQFN)		
		24 PINS		
$R_{\theta JA}$	Junction-to-ambient thermal resistance	43		°C/W
$R_{\theta JC(top)}$	Junction-to-case (top) thermal resistance	54.3		°C/W
$R_{\theta JB}$	Junction-to-board thermal resistance	20		°C/W
Ψ_{JT}	Junction-to-top characterization parameter	0.6		°C/W
Ψ_{JB}	Junction-to-board characterization parameter	19		°C/W
$R_{\theta JC(bot)}$	Junction-to-case (bottom) thermal resistance	4		°C/W

(1) For more information about traditional and new thermal metrics, see the *Semiconductor and IC Package Thermal Metrics* application report, [SPRA953](#).

7.5 Electrical Characteristics

5 V ≤ V_{VCC} ≤ 28 V, 0°C < T_J < 125°C, typical values are at T_A = 25°C, with respect to GND unless otherwise noted

PARAMETER		TEST CONDITIONS	MIN	TYP	MAX	UNIT
OPERATING CONDITIONS						
V_{VCC_OP}	VCC input voltage operating range		5		28	V
QUIESCENT CURRENTS						
I_{BAT}	Total battery discharge current (sum of currents into VCC, BTST, PH, ACP, ACN, SRP, SRN, VFB), VFB ≤ 2.1 V	$V_{VCC} < V_{SRN}$; $V_{VCC} > V_{UVLO}$ (SLEEP)			15	μA
		$V_{VCC} > V_{SRN}$; $V_{VCC} > V_{UVLO}$ CE = LOW			5	
		$V_{VCC} > V_{SRN}$; $V_{VCC} > V_{VCCLOW}$ CE = HIGH, charge done			5	
I_{AC}	Adapter supply current (current into VCC, ACP, ACN pin)	$V_{VCC} > V_{SRN}$; $V_{VCC} > V_{UVLO}$ CE = LOW		1	1.5	mA
		$V_{VCC} > V_{SRN}$; $V_{VCC} > V_{VCCLOW}$, CE = HIGH, charge done		2	5	
		$V_{VCC} > V_{SRN}$; $V_{VCC} > V_{VCCLOW}$, CE = HIGH, charging, $Q_{g_total} = 20$ nC, $V_{VCC} = 20$ V		12		
V_{FB}	Feedback regulation voltage			1.8		V
	Charge voltage regulation accuracy	$T_J = 0^\circ\text{C}$ to 125°C	-0.5%		0.5%	
		$T_J = -40^\circ\text{C}$ to 125°C	-0.7%		0.7%	

Electrical Characteristics (continued)

5 V ≤ V_{VCC} ≤ 28 V, 0°C < T_J < 125°C, typical values are at T_A = 25°C, with respect to GND unless otherwise noted

PARAMETER		TEST CONDITIONS	MIN	TYP	MAX	UNIT
Input leakage current into VFB pin		VFB = 1.8 V			100	nA
CURRENT REGULATION – FAST CHARGE						
V _{ISET1}	ISET1 voltage range				2	V
V _{IREG_CHG}	SRP–SRN current sense voltage range	V _{IREG_CHG} = V _{SRP} – V _{SRN}			100	mV
K _(ISET1)	Charger current set factor amps of charge current per volt on ISET1 pin)	R _{SENSE} = 10 mΩ		5		A/V
Charge current regulation accuracy		V _{IREG_CHG} = 40 mV	–3%		3%	
		V _{IREG_CHG} = 20 mV	–4%		4%	
		V _{IREG_CHG} = 5 mV	–25%		25%	
		V _{IREG_CHG} = 1.5 mV (V _{SRN} > 3.1 V)	–40%		40%	
I _{ISET1}	Leakage current in to ISET1 Pin	V _{ISET1} = 2 V			100	nA
CURRENT REGULATION – PRECHARGE						
Precharge current		R _{SENSE} = 10 mΩ, VFB < V _{LOWV}	50	125	200	mA
CHARGE TERMINATION						
V _{ISET2}	ISET2 voltage range				2	V
Termination current range		R _{SENSE} = 10 mΩ			2	A
K _{TERM}	Termination current set factor (amps of termination current per volt on ISET2 pin)			1		A/V
Termination current accuracy		V _{ITERM} = 20 mV	–4%		4%	
		V _{ITERM} = 5 mV	–25%		25%	
		V _{ITERM} = <1.5 mV	–45%		45%	
Deglitch time for termination (both edge)				100		ms
t _{QUAL}	Termination qualification time	V _{BAT} > V _{RECH} and I _{CHARGE} < I _{TERM}		250		ms
I _{QUAL}	Termination qualification time	Discharge current once termination is detected		2		mA
I _{ISET2}	Leakage current into ISET2 pin	V _{ISET2} = 2 V			100	nA
INPUT CURRENT REGULATION						
V _{ACSET}	ACSET voltage range		0		2	V
V _{IREG_DPM}	ACP–ACN current sense voltage range	V _{IREG_DPM} = V _{ACP} – V _{ACN}	0		100	mV
K _(ACSET)	Input current set factor (amps of input current per volt on ACSET pin)	R _{SENSE} = 10 mΩ		5		A/V
Input current regulation accuracy		V _{IREG_DPM} = 40 mV	–3%		3%	
		V _{IREG_DPM} = 20 mV	–4%		4%	
		V _{IREG_DPM} = 5 mV	–25%		25%	
I _{ACSET}	Leakage current into ACSET pin	V _{ACSET} = 2 V			100	nA
INPUT UNDERVOLTAGE LOCKOUT COMPARATOR (UVLO)						
V _{UVLO}	AC undervoltage rising threshold	Measure on VCC	3.65	3.85	4	V
V _{UVLO_HYS}	AC undervoltage hysteresis, falling			350		mV
VCC LOWV COMPARATOR						
Falling threshold, disable charge		Measure on VCC		4.1		V
Rising threshold, resume charge				4.35	4.5	V
SLEEP COMPARATOR (REVERSE DISCHARGING PROTECTION)						
V _{SLEEP_FALL}	SLEEP falling threshold	V _{VCC} – V _{SRN} to enter SLEEP	40	100	150	mV
V _{SLEEP_HYS}	SLEEP hysteresis			500		mV
SLEEP rising delay		VCC falling below SRN, delay to turn off ACFET		1		μs
SLEEP falling delay		VCC rising above SRN, delay to turn on ACFET		30		μs
SLEEP rising shutdown deglitch		VCC falling below SRN, delay to enter SLEEP mode		100		ms
SLEEP falling powerup deglitch		VCC rising above SRN, delay to exit out of SLEEP mode		30		ms
ACN / SRN COMPARATOR						
V _{ACN-SRN_FALL}	ACN to SRN falling threshold	V _{ACN} – V _{SRN} to turn on BATFET	100	200	310	mV
V _{ACN-SRN_HYS}	ACN to SRN rising hysteresis			100		mV
ACN to SRN rising deglitch		V _{ACN} – V _{SRN} > V _{ACN-SRN_RISE}		2		ms

Electrical Characteristics (continued)

5 V ≤ V_{VCC} ≤ 28 V, 0°C < T_J < 125°C, typical values are at T_A = 25°C, with respect to GND unless otherwise noted

PARAMETER		TEST CONDITIONS	MIN	TYP	MAX	UNIT
ACN to SRN falling deglitch		V _{ACN} – V _{SRN} < V _{ACN-SRN_FALL}		50		μs
BAT LOWV COMPARATOR						
V _{LOWV}	Precharge to fastcharge transition (LOWV threshold)	Measured on VFB pin, rising	0.333	0.35	0.367	V
V _{LOWV_HYS}	LOWV hysteresis			100		mV
	LOWV rising deglitch	VFB falling below VLOWV		25		ms
	LOWV falling deglitch	VFB rising above VLOWV		25		ms
RECHARGE COMPARATOR						
V _{RECHG}	Recharge threshold (with respect to VREG)	Measured on VFB pin, rising	110	125	140	mV
	Recharge rising deglitch	VFB decreasing below V _{RECHG}		10		ms
	Recharge falling deglitch	VFB increasing above V _{RECHG}		10		ms
BAT OVERVOLTAGE COMPARATOR						
V _{OV_RISE}	Overvoltage rising threshold	As percentage of V _{FB}		108%		
V _{OV_FALL}	Overvoltage falling threshold	As percentage of V _{FB}		105%		
INPUT OVERVOLTAGE COMPARATOR (ACOV)						
V _{ACOV}	AC overvoltage, rising threshold on VCC		31.04	32	32.96	V
V _{ACOV_HYS}	AC overvoltage, falling hysteresis			1		V
	AC overvoltage, deglitch (both edges)	Delay to changing the STAT pins		1		ms
	AC overvoltage, rising deglitch	Delay to disable charge		1		ms
	AC overvoltage, falling deglitch	Delay to resume charge		20		ms
THERMAL SHUTDOWN COMPARATOR						
T _{SHUT}	Thermal shutdown, rising temperature	Temperature increasing		145		°C
T _{SHUT_HYS}	Thermal shutdown hysteresis			15		°C
	Thermal shutdown rising deglitch	Temperature increasing		100		μs
	Thermal shutdown falling deglitch	Temperature decreasing		10		ms
THERMISTOR COMPARATOR						
V _{LTF}	Cold temperature, rising threshold	Charger suspended below this temperature	72.5%	73.5%	74.5%	
V _{LTF_HYS}	Cold temperature hysteresis		0.2%	0.4%	0.6%	
V _{COOL}	Cool temperature rising threshold	Charger enabled, cuts back to I _{CHARGE} /8 below this temperature	70.2%	70.7%	71.2%	
V _{COOL_HYS}	Cool temperature hysteresis		0.2%	0.6%	1.0%	
V _{WARM}	Warm temperature rising threshold	Charger cuts back to I _{CHARGE} /8 above this temperature	47.5%	48%	48.5%	
V _{WARM_HYS}	Warm temperature hysteresis		1.0%	1.2%	1.4%	
V _{HTF}	Hot temperature rising threshold	Charger suspended above this temperature before initiating charge	36.2%	37%	37.8%	
V _{TCO}	Cutoff temperature rising threshold	Charger suspended above this temperature during initiating charge	33.7%	34.4%	35.1%	
	Deglitch time for temperature out-of-range detection	V _{TS} > V _{LTF} , or V _{TS} < V _{TCO} , or V _{TS} < V _{HTF}		400		ms
	Deglitch time for temperature in-valid-range detection	V _{TS} < V _{LTF} – V _{LTF_HYS} or V _{TS} > V _{TCO} or V _{TS} > V _{HTF}		20		ms
	Deglitch time for current reduction to I _{CHARGE} /8 due to warm or cool temperature	V _{TS} > V _{COOL} , or V _{TS} < V _{WARM}		25		ms
	Deglitch time to charge at I _{CHARGE} from I _{CHARGE} /8 when resuming from warm or cool temperatures	V _{TS} < V _{COOL} – V _{COOL_HYS} , or V _{TS} > V _{WARM} – V _{WARM_HYS}		25		ms
	Charge current due to warm or cool temperatures	V _{COOL} < V _{TS} < V _{LTF} , or V _{WARM} < V _{TS} < V _{HTF} , or V _{WARM} < V _{TS} < V _{TCO}		I _{CHARGE} /8		
CHARGE OVERCURRENT COMPARATOR (CYCLE-BY-CYCLE)						

Electrical Characteristics (continued)

5 V ≤ V_{VCC} ≤ 28 V, 0°C < T_J < 125°C, typical values are at T_A = 25°C, with respect to GND unless otherwise noted

PARAMETER		TEST CONDITIONS	MIN	TYP	MAX	UNIT
V _{OC}	Charge overcurrent falling threshold	Current rising, in non-synchronous mode, measure on V _(SRP-SRN) , V _{SRP} < 2 V		45.5		mV
		Current rising, as percentage of V _(IREG_CHG) , in synchronous mode, V _{SRP} > 2.2 V		160%		
	Charge overcurrent threshold floor	Minimum OCP threshold in synchronous mode, measure on V _(SRP-SRN) , V _{SRP} > 2.2 V		50		mV
	Charge overcurrent threshold ceiling	Maximum OCP threshold in synchronous mode, measure on V _(SRP-SRN) , V _{SRP} > 2.2 V		180		mV
CHARGE UNDERCURRENT COMPARATOR (CYCLE-BY-CYCLE)						
V _{ISYNSET}	Charge under-current falling threshold	Switch from SYNCH to NON-SYNCH, V _{SRP} > 2.2 V	1	5	9	mV
BATTERY SHORTED COMPARATOR (BATSHORT)						
V _{BATSHT}	BAT short falling threshold, forced non-synchronous mode	V _{SRP} falling		2		V
V _{BATSHT_HYS}	BAT short rising hysteresis			200		mV
V _{BATSHT_DEG}	Deglitch on both edge			1		μs
LOW CHARGE CURRENT COMPARATOR						
V _{LC}	Average low charge current falling threshold	Measure on V _(SRP-SRN) , forced into non-synchronous mode		1.25		mV
V _{LC_HYS}	Low charge current rising hysteresis			1.25		mV
V _{LC_DEG}	Deglitch on both edge			1		μs
VREF REGULATOR						
V _{VREF_REG}	VREF regulator voltage	V _{VCC} > V _{UVLO} , (0 – 35 mA load)	3.267	3.3	3.333	V
I _{VREF_LIM}	VREF current limit	V _{VREF} = 0 V, V _{VCC} > V _{UVLO}	35			mA
REGN REGULATOR						
V _{REGN_REG}	REGN regulator voltage	V _{VCC} > 10 V, CE = HIGH (0–40 mA load)	5.7	6	6.3	V
I _{REGN_LIM}	REGN current limit	V _{REGN} = 0 V, V _{VCC} > V _{UVLO}	40			mA
TTC INPUT						
T _{PRECHG}	Precharge safety timer range ⁽¹⁾	Precharge time before fault occurs	1440	1800	2160	s
T _{CHARGE}	Fast-charge safety timer range, with ±10% accuracy ⁽¹⁾	Tchg = C _{TTC} × K _{TTC}	1		10	h
		Fast charge timer accuracy ⁽¹⁾	–10%		10%	
K _{TTC}	Timer multiplier	0.047 μF ≤ C _{TTC} ≤ 0.47 μF		1.4		min/nF
	TTC low threshold	V _{TTC} below this threshold disables the safety timer and termination			0.4	V
	TTC comparator high threshold			1.5		V
	TTC comparator low threshold			1		V
	TTC source/sink current		45	50	55	μA
BATTERY SWITCH (BATFET) DRIVER						
R _{DS_BAT_OFF}	BATFET turnoff resistance	V _{ACN} > 5 V			150	Ω
R _{DS_BAT_ON}	BATFET turnon resistance	V _{ACN} > 5 V			20	kΩ
V _{BATDRV_REG}	BATFET drive voltage	V _{BATDRV_REG} = V _{ACN} – V _{BATDRV} when V _{ACN} > 5 V and BATFET is on	4.2		7	V
AC SWITCH (ACFET) DRIVER						
R _{DS_AC_OFF}	ACFET turnoff resistance	V _{VCC} > 5 V			30	Ω
R _{DS_AC_ON}	ACFET turnon resistance	V _{VCC} > 5 V			20	kΩ
V _{ACDRV_REG}	ACFET drive voltage	V _{ACDRV_REG} = V _{VCC} – V _{ACDRV} when V _{VCC} > 5 V and ACFET is on	4.2		7	V
AC / BAT MOSFET DRIVERS TIMING						
	Driver dead time	Dead time when switching between AC and BAT		10		μs
BATTERY DETECTION						
t _{WAKE}	Wake timer	Max. time charge is enabled		500		ms
I _{WAKE}	Wake current	R _{SENSE} = 10 mΩ	50	125	200	mA

(1) Verified by design.

Electrical Characteristics (continued)

5 V ≤ V_{VCC} ≤ 28 V, 0°C < T_J < 125°C, typical values are at T_A = 25°C, with respect to GND unless otherwise noted

PARAMETER		TEST CONDITIONS	MIN	TYP	MAX	UNIT
t _{DISCHARGE}	Discharge timer	Max time discharge current is applied		1		sec
I _{DISCHARGE}	Discharge current			8		mA
I _{FAULT}	Fault current after a timeout fault			2		mA
V _{WAKE}	Wake threshold (with respect to V _{REG})	Voltage on VFB to detect battery absent during wake		125		mV
V _{DISCH}	Discharge threshold	Voltage on VFB to detect battery absent during discharge		0.35		V
PWM HIGH SIDE DRIVER (HIDRV)						
R _{DS_HI_ON}	High Side driver (HSD) turnon resistance	V _{BTST} – V _{PH} = 5.5 V		3.3	6	Ω
R _{DS_HI_OFF}	High Side driver turnoff resistance	V _{BTST} – V _{PH} = 5.5 V		1	1.3	Ω
V _{BTST_REFRESH}	Bootstrap refresh comparator threshold voltage	V _{BTST} – V _{PH} when low side refresh pulse is requested	4	4.2		V
PWM LOW SIDE DRIVER (LODRV)						
R _{DS_LO_ON}	Low side driver (LSD) turnon resistance			4.1	7	Ω
R _{DS_LO_OFF}	Low side driver turnoff resistance			1	1.4	Ω
PWM DRIVERS TIMING						
	Driver dead time	Dead time when switching between LSD and HSD, no load at LSD and HSD		30		ns
PWM OSCILLATOR						
V _{RAMP_HEIGHT}	PWM ramp height	As percentage of VCC		7%		
	PWM switching frequency ⁽¹⁾		255	300	345	kHz
INTERNAL SOFT START (8 Steps to Regulation Current ICHG)						
	Soft-start steps			8		step
	Soft-start step time			1.6		ms
CHARGER SECTION POWER-UP SEQUENCING						
	Charge-enable delay after power up	Delay from when adapter is detected to when the charger is allowed to turn on		1.5		s
LOGIC IO PIN CHARACTERISTICS						
V _{IN_LO}	CE input low threshold voltage				0.8	V
V _{IN_HI}	CE input high threshold voltage		2.1			V
V _{BIAS_CE}	CE input bias current	V = 3.3 V (CE has internal 1-MΩ pulldown resistor)			6	μA
V _{OUT_LO}	STAT1, STAT2, \overline{PG} output low saturation voltage	Sink current = 5 mA			0.5	V
I _{OUT_HI}	Leakage current	V = 32 V			1.2	μA

7.6 Typical Characteristics

Table 1. Table of Graphs

	FIGURE
REF, REGN, and PG Power Up (CE = 1)	Figure 1
Charge Enable	Figure 2
Current Soft-Start (CE = 1)	Figure 3
Charge Disable	Figure 4
Continuous-Conduction-Mode Switching Waveforms	Figure 5
Cycle-by-Cycle Synchronous to Nonsynchronous	Figure 6
100% Duty and Refresh Pulse	Figure 7
Transient System Load (DPM)	Figure 8
Battery Insertion	Figure 9
Battery-to-Ground Short Protection	Figure 10
Battery-to-Ground Short Transition	Figure 11
Efficiency vs Output Current	Figure 12
Input ACOV Transition	Figure 13
Input ACOV Resume Normal Transition	Figure 14

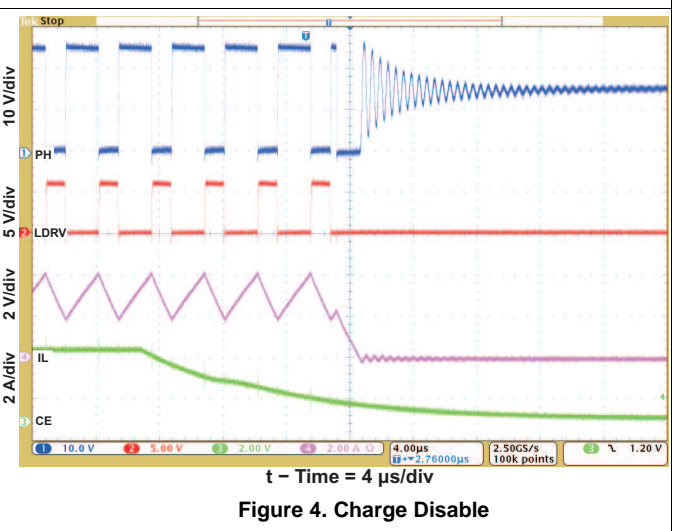
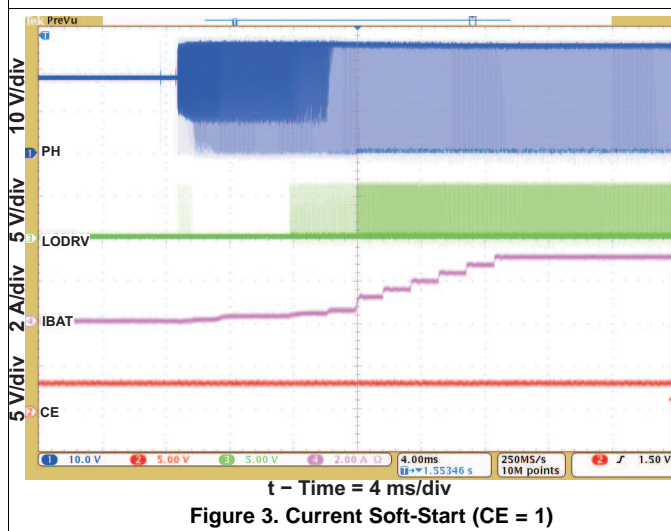
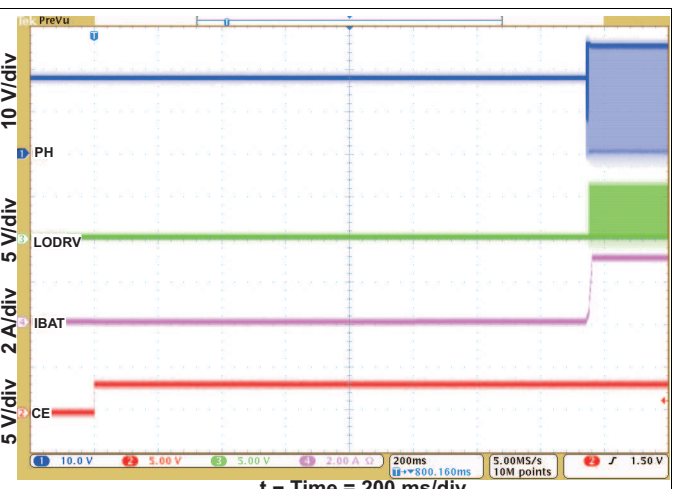
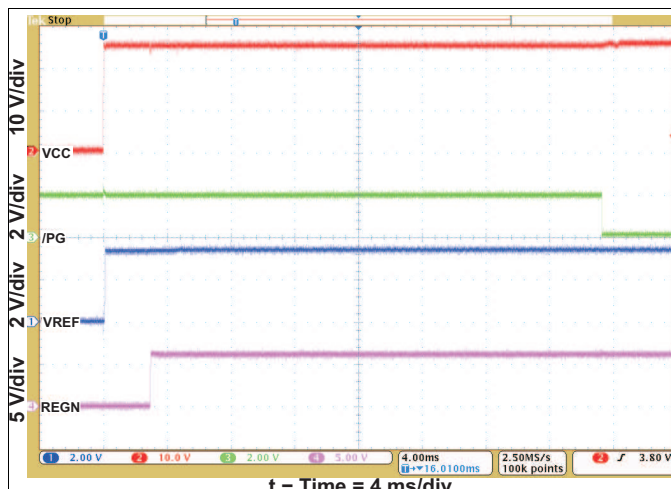

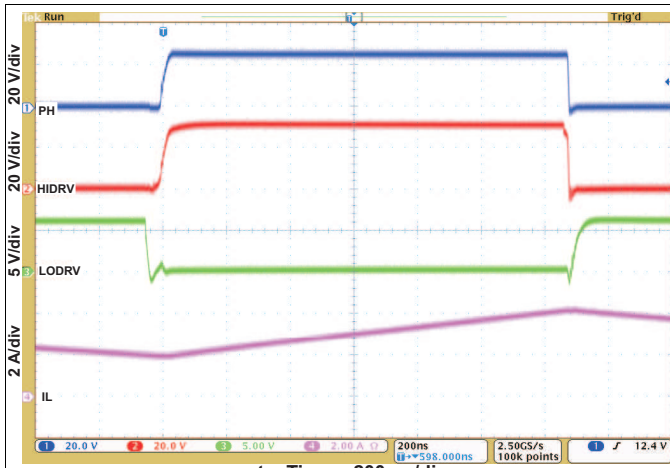

Figure 5. Continuous-Conduction Mode Switching Waveform

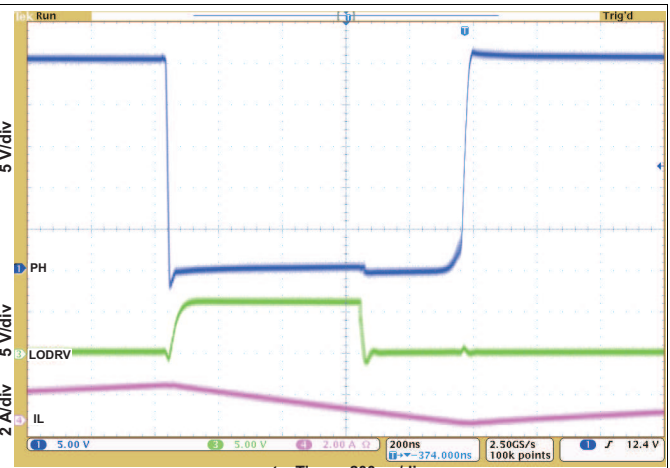

Figure 6. Cycle-by-Cycle Synchronous to Nonsynchronous

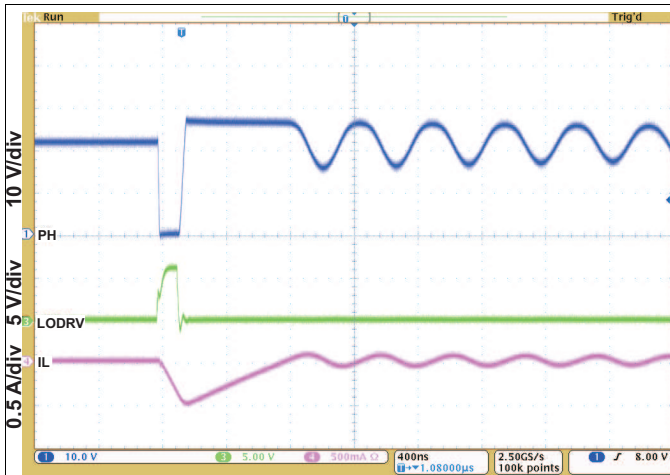

Figure 7. 100% Duty and Refresh Pulse

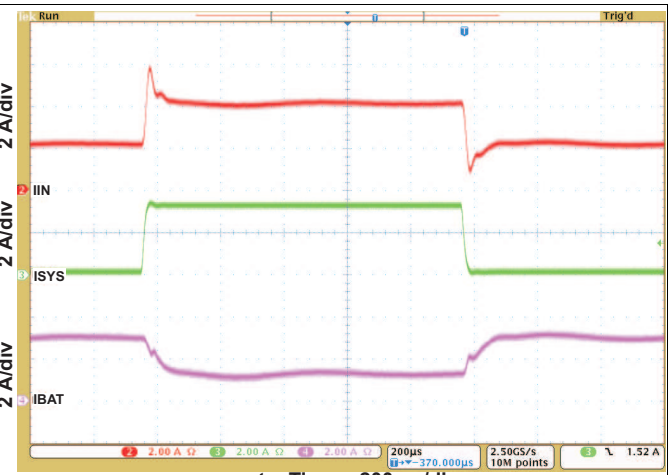

Figure 8. Transient System Load (DPM)

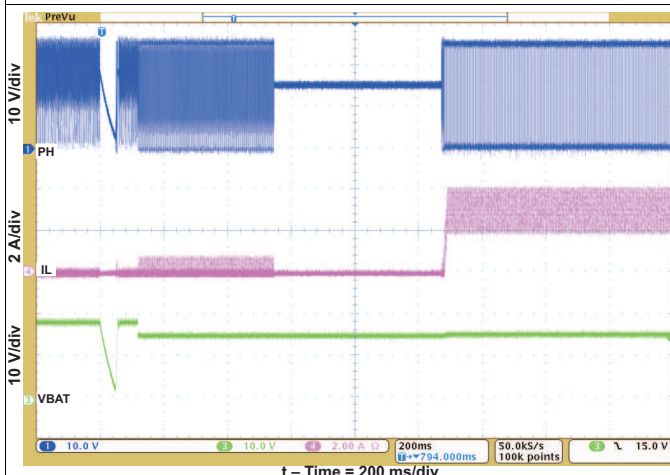

Figure 9. Battery Insertion

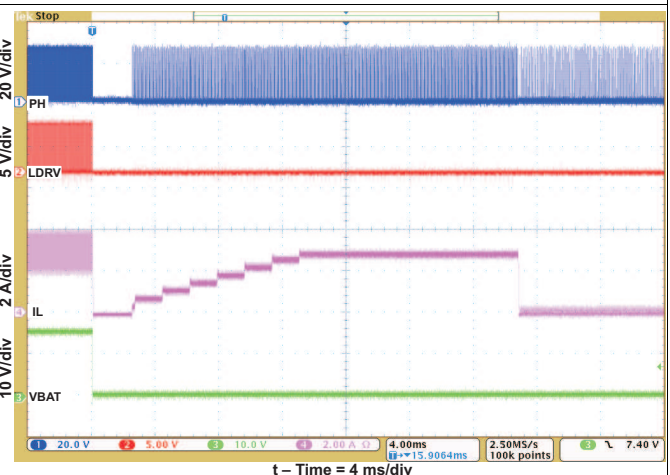

Figure 10. Battery-to-GND Short Protection

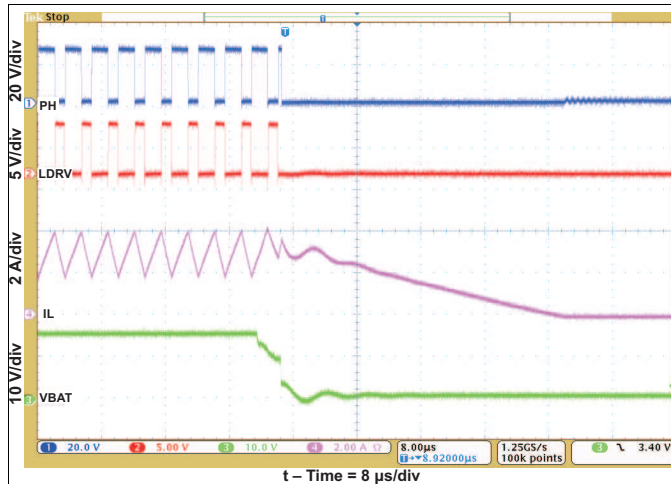

Figure 11. Battery-to-GND Short Transition

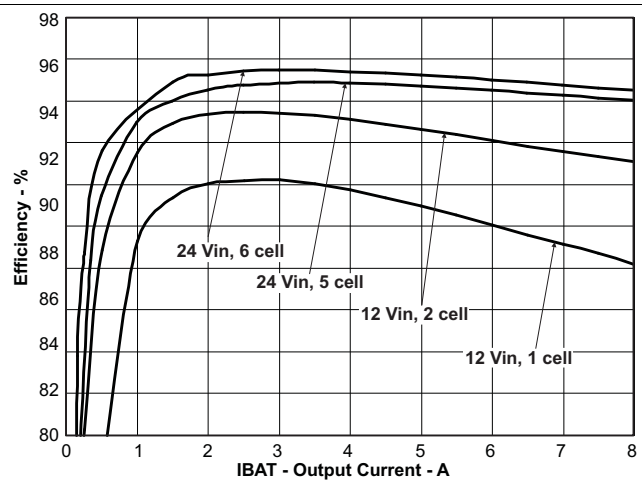

Figure 12. Efficiency vs Output Current

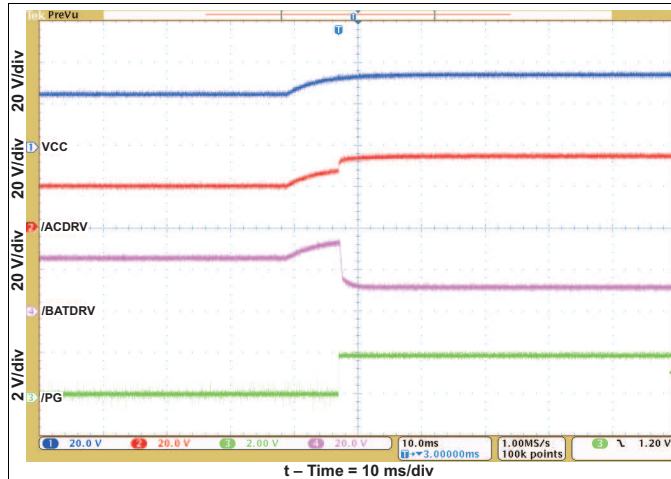

Figure 13. Input ACOV Transition

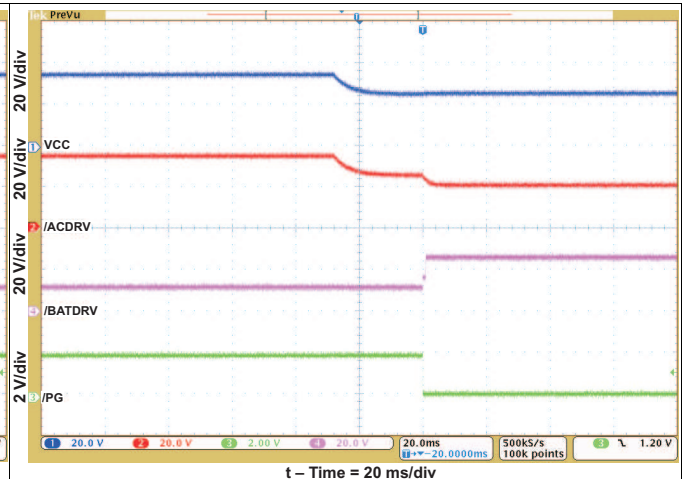

Figure 14. Input ACOV Resume Normal Transition

8 Detailed Description

8.1 Overview

The bq24630 device is a stand-alone, integrated lithium phosphate battery charger. The device employs a switched-mode synchronous buck PWM controller with constant switching frequency. The device controls external switches to prevent battery discharge back to the input, connect the adapter to the system, and connect the battery to the system using 6-V gate drives for better system efficiency. The bq24630 features Dynamic Power Management (DPM) which reduces battery charge current when the input power limit is reached to avoid overloading the AC adapter when supplying current to the system and the battery charger simultaneously. A highly accurate current-sense amplifier enables precise measurement of input current from the AC adapter to monitor the overall system power. The input current limit can be configured through the ACSET pin of the device.

The bq24630 has a battery detect scheme that allows it to automatically detect the presence and absence of a battery. When the battery is detected, charging begins in one of three phases (depending upon battery voltage): precharge, constant current (fast-charge current regulation), and constant voltage (fast-charge voltage regulation). The device will terminate charging when the termination current threshold has been reached and will begin a recharge cycle when the battery voltage has dropped below the recharge threshold (V_{RECHG}). Precharge, constant current, and termination current can be configured through the ISET1 and ISET2 pins, allowing for flexibility in battery charging profile. During charging, the integrated fault monitors of the device, such as battery overvoltage protection, battery short detection (V_{BATSHD}), thermal shutdown (internal T_{SHUT} and TS pin), safety timer expiration (TTC pin), and input voltage protection (V_{ACOV}), ensure battery safety.

The bq24630 has three status pins (STAT1, STAT2, and \overline{PG}) to indicate the charging status and input voltage (AC adapter) status. These pins can be used to drive LEDs or communicate with a host processor.

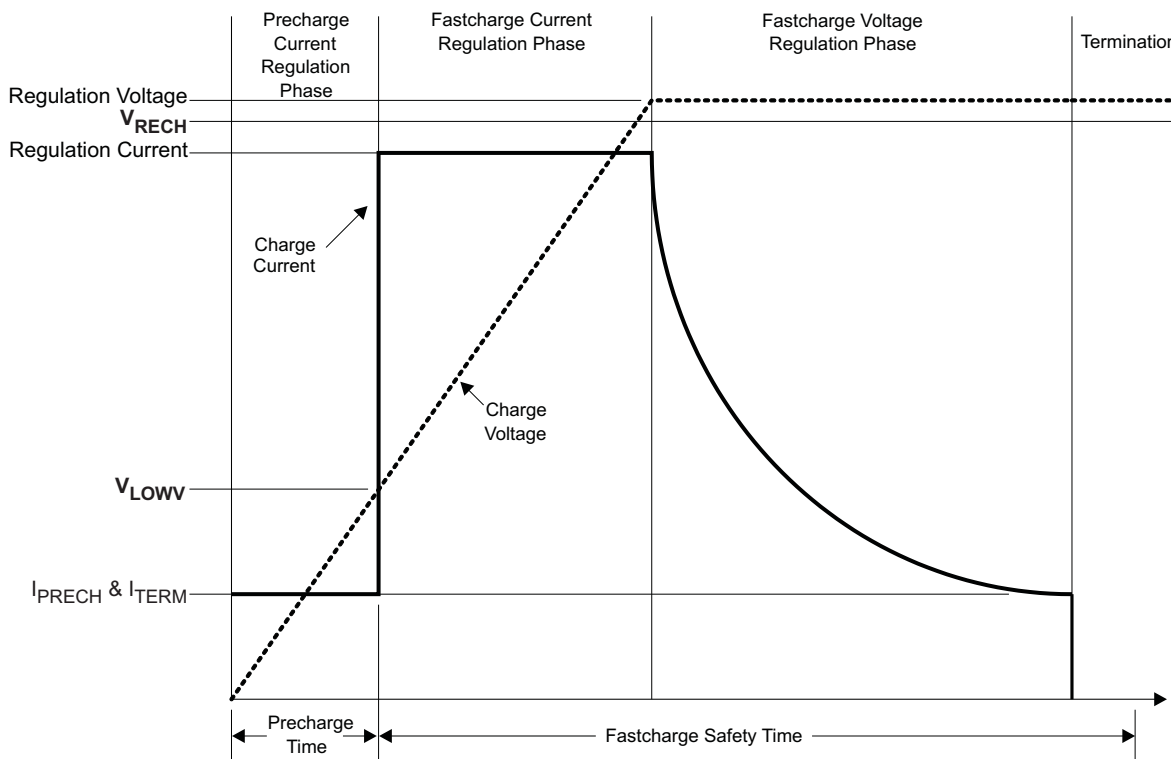
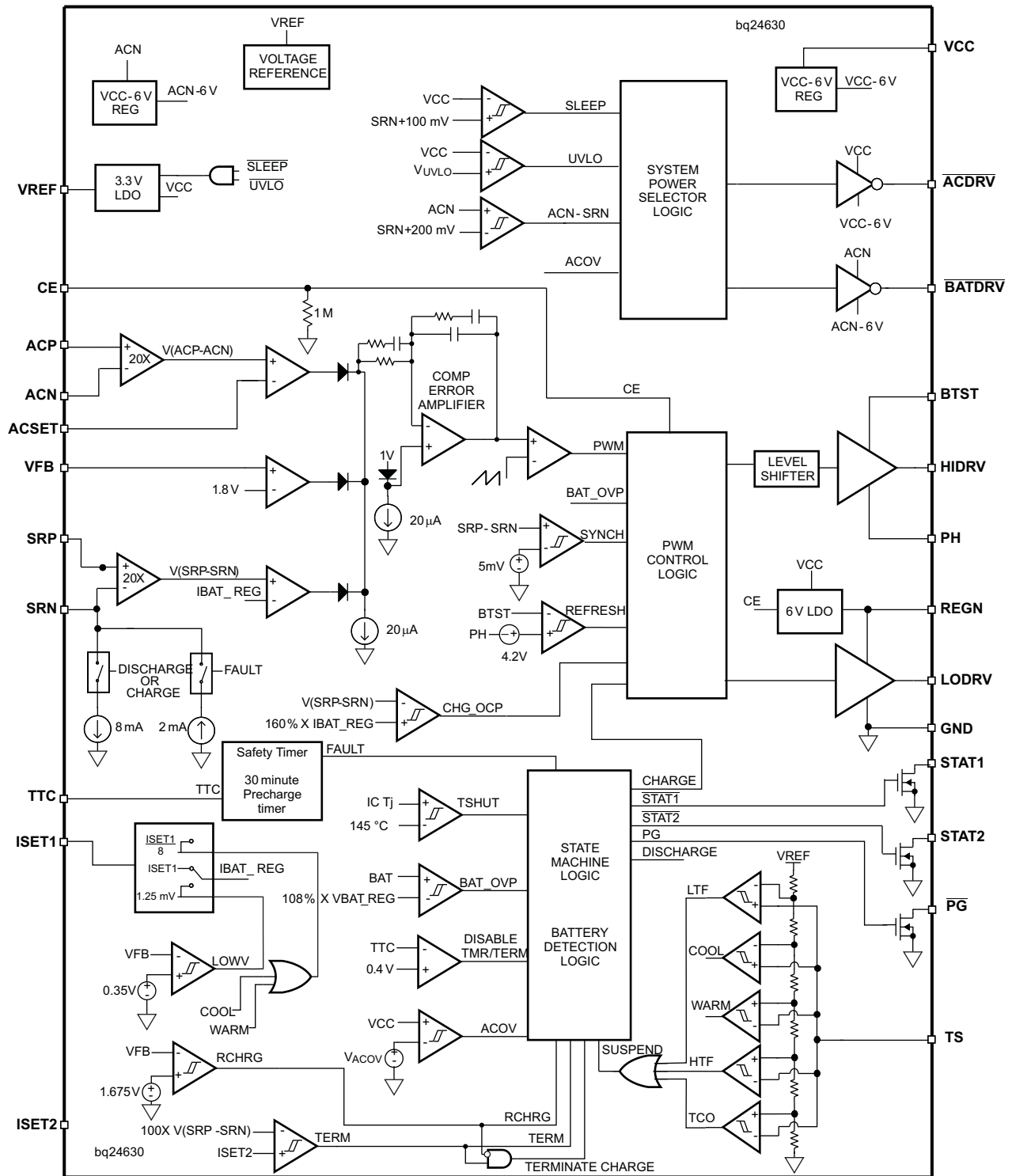

Figure 15. Typical Charging Profile

8.2 Functional Block Diagram



8.3 Feature Description

8.3.1 Battery Voltage Regulation

The bq24630 uses a high-accuracy voltage band gap and regulator for the high-accuracy charging voltage. The charge voltage is programmed via a resistor divider from the battery to ground, with the midpoint tied to the VFB pin. The voltage at the VFB pin is regulated to 1.8 V, giving Equation 1 for the regulation voltage:

$$V_{\text{BAT}} = 1.8 \text{ V} \times \left[1 + \frac{R_2}{R_1} \right] \quad (1)$$

Where R2 is connected from VFB to the battery and R1 is connected from VFB to GND.

8.3.2 Battery Current Regulation

The ISET1 input sets the maximum fast-charge current. Battery charge current is sensed by resistor R_{SR} connected between SRP and SRN. The full-scale differential voltage between SRP and SRN is 100 mV. Thus, for a 10-mΩ sense resistor, the maximum charging current is 10 A. Equation 2 is for charge current:

$$I_{\text{CHARGE}} = \frac{V_{\text{ISET1}}}{20 \times R_{\text{SR}}} \quad (2)$$

V_{ISET1}, the input voltage range of ISET1, is between 0 and 2 V. The SRP and SRN pins are used to sense voltage across R_{SR} with default value of 10 mΩ. However, resistors of other values can also be used. A larger sense resistor gives a larger sense voltage and a higher regulation accuracy, but at the expense of higher conduction loss.

8.3.3 Precharge

On powerup, if the battery voltage is below the V_{LOWV} threshold, the bq24630 applies 125 mA precharge current to the battery ⁽¹⁾. The precharge feature is intended to revive deeply discharged cells. If the V_{LOWV} threshold is not reached within 30 minutes of initiating precharge, the charger turns off and a FAULT is indicated on the status pins.

8.3.4 Input Adapter Current Regulation

The total input from an ac adapter or other dc source is a function of the system supply current and the battery charging current. System current normally fluctuates as portions of the system are powered up or down. Without dynamic power management (DPM), the source must be able to supply the maximum system current and the maximum charger input current simultaneously. By using DPM, the input current regulator reduces the charging current when the input current exceeds the input current limit set by ACSET. The current capability of the ac adaptor can be lowered, reducing system cost.

Similar to setting battery regulation current, adaptor current is sensed by resistor R_{AC} connected between ACP and ACN. Its maximum value is set by ACSET using Equation 3:

$$I_{\text{DPM}} = \frac{V_{\text{ACSET}}}{20 \times R_{\text{AC}}} \quad (3)$$

V_{ACSET}, the input voltage range of ACSET is between 0 and 2 V. The ACP and ACN pins are used to sense voltage across R_{AC} with a default value of 10 mΩ. However, resistors of other values can also be used. A larger the sense resistor gives a larger sense voltage and a higher regulation accuracy, but at the expense of higher conduction loss.

8.3.5 Charge Termination, Recharge, and Safety Timer

The bq24630 monitors the charging current during the voltage regulation phase. When V_{TTC} is valid, termination is detected while the voltage on the VFB pin is higher than the V_{RECH} threshold AND the charge current is less than the I_{TERM} threshold, as calculated in Equation 4:

$$I_{\text{TERM}} = \frac{V_{\text{ISET2}}}{100 \times R_{\text{SR}}} \quad (4)$$

(1) Assuming a 10-mΩ sense resistor. 1.25 mV is regulated across SRP-SRN, regardless of the value of the sense resistor.

Feature Description (continued)

V_{ISET2} , the input voltage of ISET2 is between 0 and 2 V. The minimum termination current is clamped to be around 125 mA with a default 10-m Ω sensing resistor. To avoid early termination during WARM/COOL condition, set $I_{TERM} \leq I_{CHARGE}/10$. As a safety backup, the bq24630 also provides a programmable charge timer. The charge time is programmed by the capacitor connected between the TTC pin and GND, and is given by [Equation 5](#):

$$t_{CHARGE} = C_{TTC} \times K_{TTC} \quad (5)$$

Where C_{TTC} (range from 0.047 μ F to 0.47 μ F to give 1-h to 10-h safety timer) is the capacitor connected from TTC pin to GND, and K_{TTC} is the constant multiplier (1.4 min/nF).

A new charge cycle is initiated and the safety timer is reset when one of the following conditions occurs:

- The battery voltage falls below the recharge threshold.
- A power-on-reset (POR) event occurs.
- CE is toggled.

The TTC pin may be taken LOW to disable termination and to disable the safety timer. If TTC is pulled to VREF, the bq24630 continues to allow termination but disables the safety timer. TTC taken low resets the safety timer. When ACOV, VCLOWV, and SLEEP mode resume normal, the safety timer is reset.

8.3.6 Power Up

The bq24630 uses a SLEEP comparator to determine the source of power on the VCC pin, because VCC can be supplied either from the battery or the adapter. If the VCC voltage is greater than the SRN voltage, the bq24630 enables ACFET and disables BATFET. If all other conditions are met for charging, the bq24630 then attempts to charge the battery (see [Enable and Disable Charging](#) section). If the SRN voltage is greater than VCC, indicating that the battery is the power source, the bq24630 enables the BATFET and enters a low-quiescent-current (<15- μ A) SLEEP mode to minimize current drain from the battery.

If VCC is below the UVLO threshold, the device is disabled, ACFET turns off, and BATFET turns on.

8.3.7 Enable and Disable Charging

The following conditions must be valid before charge is enabled:

- CE is HIGH.
- The device is not in undervoltage lockout (UVLO) and not in VCLOWV mode.
- The device is not in SLEEP mode.
- The VCC voltage is lower than the ac overvoltage threshold ($VCC < V_{ACOV}$).
- 30-ms delay is complete after initial power up.
- The REGN LDO and VREF LDO voltages are at the correct levels.
- Thermal shut (TSHUT) is not valid.
- TS fault is not detected.

Any of the following conditions stops ongoing charging:

- CE is LOW.
- Adapter is removed, causing the device to enter UVLO, VCLOWV, or SLEEP mode.
- Adapter is over voltage.
- The REGN or VREF LDOs are overloaded.
- TSHUT IC temperature threshold is reached (145°C on rising edge with 15°C hysteresis).
- TS voltage goes out of range, indicating the battery temperature is too hot or too cold.
- TTC safety timer times out.

8.3.8 System Power Selector

The bq24630 automatically switches adapter or battery power to the system load. The battery is connected to the system by default during power up or during SLEEP mode. The battery is disconnected from the system and then the adapter is connected to the system 30 ms after exiting SLEEP. Automatic break-before-make logic prevents shoot-through currents when the selectors switch.

Feature Description (continued)

$\overline{\text{ACDRV}}$ is used to drive a pair of back-to-back p-channel power MOSFETs between adapter and ACP with sources connected together and to VCC. The FET connected to the adapter prevents reverse discharge from the battery to the adapter when turned off. The p-channel FET with the drain connected to the adapter input provides reverse battery discharge protection when off; and also minimizes system power dissipation, with its low $r_{\text{DS(on)}}$, compared to a Schottky diode. The other p-channel FET connected to ACP separates the battery from the adapter, and provides a limited dI/dt when connecting the adapter to the system by controlling the FET turnon time. $\overline{\text{BATDRV}}$ controls a p-channel power MOSFET placed between BAT and the system.

When an adapter is not detected, $\overline{\text{ACDRV}}$ is pulled to VCC to keep ACFET off, disconnecting the adapter from system. $\overline{\text{BATDRV}}$ stays at ACN-6V to connect the battery to the system.

Approximately 30 ms after the device comes out of SLEEP mode, the system begins to switch from battery to adapter. The break-before-make logic keeps both ACFET and BATFET off for 10 μs before ACFET turns on. This prevents shoot-through current or any large discharging current from going into the battery. $\overline{\text{BATDRV}}$ is pulled up to ACN and the $\overline{\text{ACDRV}}$ pin is set to VCC-6V by an internal regulator to turn on p-channel ACFET, connecting the adapter to the system.

When the adapter is removed, the system waits until VCC drops back to within 200 mV above SRN to switch from the adapter back to the battery. The break-before-make logic still keeps 10- μs dead time. $\overline{\text{ACDRV}}$ is pulled up to VCC and the $\overline{\text{BATDRV}}$ pin is set to ACN-6V by an internal regulator to turn on p-channel BATFET, connecting the battery to the system.

Asymmetrical gate drive for the $\overline{\text{ACDRV}}$ and $\overline{\text{BATDRV}}$ drivers provides fast turnoff and slow turnon of ACFET and BATFET to help the break-before-make logic and to allow a soft-start at turnon of either FET. The soft-start time can be further increased by putting a capacitor from gate to source of the p-channel power MOSFETs.

8.3.9 Automatic Internal Soft-Start Charger Current

The charger automatically soft-starts the charger regulation current every time the charger goes into fast-charge to ensure there is no overshoot or stress on the output capacitors or the power converter. The soft-start consists of stepping up the charge regulation current in eight evenly divided steps up to the programmed charge current. Each step lasts around 1.6 ms, for a typical rise time of 12.8 ms. No external components are needed for this function.

8.3.10 Converter Operation

The synchronous buck PWM converter uses a fixed-frequency voltage mode with feed-forward control scheme. A type-III compensation network allows using ceramic capacitors at the output of the converter. The compensation input stage is connected internally between the feedback output (FBO) and the error amplifier input (EAI). The feedback compensation stage is connected between the error amplifier input (EAI) and error amplifier output (EAO). The LC output filter is selected to give a resonant frequency of 10 kHz to 15 kHz for the bq24630, where the resonant frequency, f_o , is given by [Equation 6](#):

$$f_o = \frac{1}{2\pi\sqrt{L_o C_o}} \quad (6)$$

An internal saw-tooth ramp is compared to the internal EAO error control signal to vary the duty cycle of the converter. The ramp height is 7% of the input adapter voltage making it always directly proportional to the input adapter voltage. This cancels out any loop gain variation due to a change in input voltage, and simplifies the loop compensation. The ramp is offset by 300 mV in order to allow zero-percent duty cycle when the EAO signal is below the ramp. The EAO signal is also allowed to exceed the saw-tooth ramp signal in order to get a 100% duty-cycle PWM request. Internal gate drive logic allows achieving 99.95% duty cycle while ensuring the N-channel upper device always has enough voltage to stay fully on. If the BTST pin to PH pin voltage falls below 4.2 V for more than three cycles, then the high-side n-channel power MOSFET is turned off and the low-side n-channel power MOSFET is turned on to pull the PH node down and recharge the BTST capacitor. Then the high-side driver returns to 100% duty-cycle operation until the BTST-to-PH voltage is detected to fall low again due to leakage current discharging the BTST capacitor below 4.2 V, and the reset pulse is reissued.

The fixed-frequency oscillator keeps tight control of the switching frequency under all conditions of input voltage, battery voltage, charge current, and temperature, simplifying output filter design and keeping it out of the audible noise region. Also see the [Application Information](#) section for how to select the inductor, capacitor, and MOSFET.

Feature Description (continued)

8.3.11 Synchronous and Non-Synchronous Operation

The charger operates in synchronous mode when the SRP-SRN voltage is above 5 mV (0.5-A inductor current for a 10-m Ω sense resistor). During synchronous mode, the internal gate-drive logic ensures there is break-before-make complementary switching to prevent shoot-through currents. During the 30-ns dead time where both FETs are off, the body diode of the low-side power MOSFET conducts the inductor current. Having the low-side FET turn on keeps the power dissipation low, and allows safely charging at high currents. During synchronous mode, the inductor current is always flowing and the converter operates in continuous-conduction mode (CCM), creating a fixed two-pole system.

The charger operates in non-synchronous mode when the SRP-SRN voltage is below 5 mV (0.5-A inductor current for a 10-m Ω sense resistor). The charger is forced into non-synchronous mode when battery voltage is lower than 2 V or when the average SRP-SRN voltage is lower than 1.25 mV.

During non-synchronous operation, the body-diode of the low-side MOSFET can conduct the positive inductor current after the high-side n-channel power MOSFET turns off. When the load current decreases and the inductor current drops to zero, the body diode is naturally turned off and the inductor current becomes discontinuous. This mode is called discontinuous-conduction mode (DCM). During DCM, the low-side n-channel power MOSFET turns on for around 80 ns when the bootstrap capacitor voltage drops below 4.2 V; then the low-side power MOSFET turns off and stays off until the beginning of the next cycle, where the high-side power MOSFET is turned on again. The 80-ns low-side MOSFET on-time is required to ensure the bootstrap capacitor is always recharged and able to keep the high-side power MOSFET on during the next cycle. This is important for battery chargers, where unlike regular dc-dc converters, there is a battery load that maintains a voltage and can both source and sink current. The 80-ns low-side pulse pulls the PH node (connection between high- and low-side MOSFETs) down, allowing the bootstrap capacitor to recharge up to the REGN LDO value. After 80 ns, the low-side MOSFET is kept off to prevent negative inductor current from occurring.

At very low currents during non-synchronous operation, there may be a small amount of negative inductor current during the 80-ns recharge pulse. The charge should be low enough to be absorbed by the input capacitance. Whenever the converter goes into zero-percent duty cycle, the high-side MOSFET does not turn on, and the low-side MOSFET does not turn on (only 80-ns recharge pulse) either, and there is almost no discharge from the battery.

During the DCM mode, the loop response automatically changes and has a single-pole system at which the pole is proportional to the load current, because the converter does not sink current, and only the load provides a current sink. This means at very low currents the loop response is slower, as there is less sinking current available to discharge the output voltage.

8.3.12 Cycle-By-Cycle Charge Undercurrent Protection

If the SRP-SRN voltage decreases below 5 mV (the charger is also forced into non-synchronous mode when the average SRP-SRN voltage is lower than 1.25 mV), the low-side FET is turned off for the remainder of the switching cycle to prevent negative inductor current. During DCM, the low-side FET only turns on for at around 80 ns when the bootstrap capacitor voltage drops below 4.2 V to provide refresh charge for the bootstrap capacitor. This is important to prevent negative inductor current from causing a boost effect in which the input voltage increases as power is transferred from the battery to the input capacitors and leads to an overvoltage stress on the VCC node and potentially causes damage to the system.

8.3.13 Input Overvoltage Protection (ACOV)

ACOV provides protection to prevent system damage due to high input voltage. Once the adapter voltage reaches the ACOV threshold, charge is disabled and the battery is switched to the system instead of the adapter.

8.3.14 Input Undervoltage Lockout (UVLO)

The system must have a minimum VCC voltage to allow proper operation. This VCC voltage could come from either the input adapter or the battery, because a conduction path exists from the battery to VCC through the high-side NMOS body diode. When VCC is below the UVLO threshold, all circuits on the IC are disabled, and the gate drive bias to ACFET and BATFET is disabled.

Feature Description (continued)

8.3.15 Battery Overvoltage Protection

The converter does not allow the high-side FET to turn on until the BAT voltage goes below 105% of the regulation voltage. This allows one-cycle response to an overvoltage condition, such as occurs when the load is removed or the battery is disconnected. An 8-mA current sink from SRP to GND is on only during charge and allows discharging the stored output inductor energy that is transferred to the output capacitors. BATOVP also suspends the safety timer.

8.3.16 Cycle-By-Cycle Charge Overcurrent Protection

The charger has a secondary cycle-to-cycle overcurrent protection. It monitors the charge current, and prevents the current from exceeding 160% of the programmed charge current. The high-side gate drive turns off when the overcurrent is detected, and automatically resumes when the current falls below the overcurrent threshold.

8.3.17 Thermal Shutdown Protection

The QFN package has low thermal impedance, which provides good thermal conduction from the silicon to the ambient, to keep junction temperatures low. As an added level of protection, the charger converter turns off and self-protects whenever the junction temperature exceeds the TSHUT threshold of 145°C. The charger stays off until the junction temperature falls below 130°C. Then the charger soft-starts again if all other enable-charge conditions are valid. Thermal shutdown also suspends the safety timer.

8.3.18 Temperature Qualification

The controller continuously monitors battery temperature by measuring the voltage between the TS pin and GND. A negative-temperature-coefficient thermistor (NTC) and an external voltage divider typically develop this voltage. The controller compares this voltage against its internal thresholds to determine if charging is allowed. To initiate a charge cycle, the battery temperature must be within the V_{LTF} to V_{HTF} thresholds. If battery temperature is outside of this range, the controller suspends charge and the safety timer, and waits until the battery temperature is within the V_{LTF} to V_{HTF} range. During the charge cycle, the battery temperature must be within the V_{LTF} to V_{TCO} thresholds. If the battery temperature is outside of this range, the controller suspends charge and the safety timer, and waits until the battery temperature is within the V_{LTF} to V_{HTF} range. If the battery temperature is between the V_{LTF} and V_{COOL} thresholds or between the V_{HTF} and V_{WARM} thresholds, charge is automatically reduced to $I_{CHARGE}/8$. To avoid early termination during a COOL/WARM condition, set $I_{TERM} \leq I_{CHARGE}/10$. The controller suspends charge by turning off the PWM charge FETs. [Figure 16](#) and [Figure 17](#) summarize the operation.

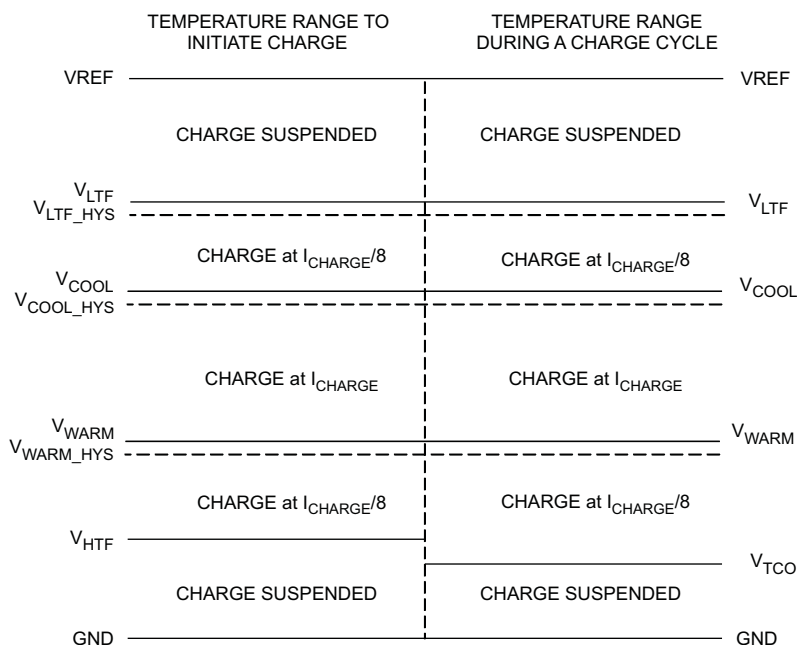
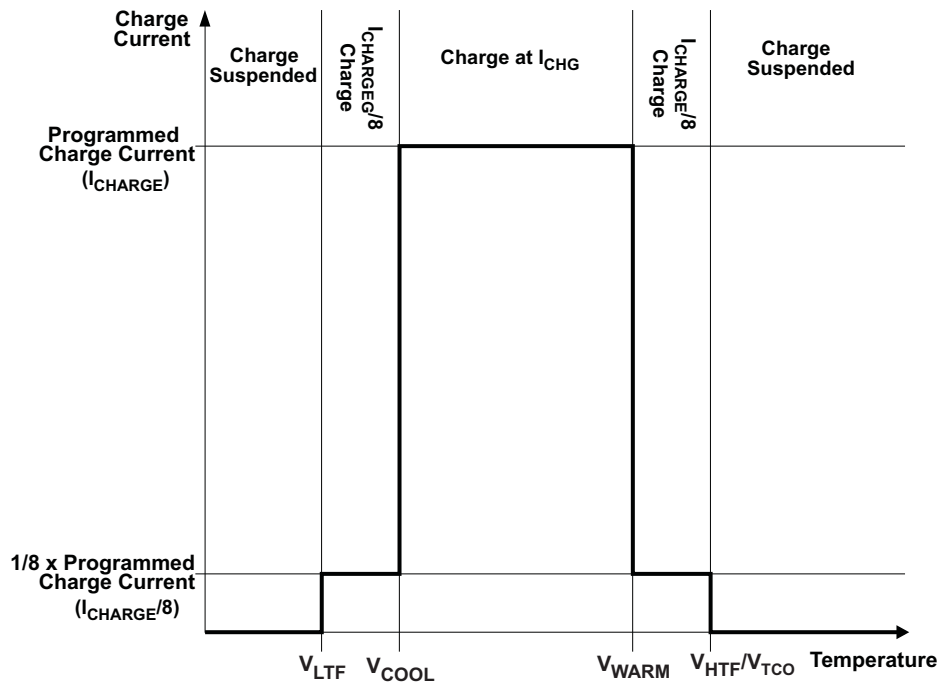

Figure 16. TS, Thermistor Sense Thresholds

Feature Description (continued)

Figure 17. Typical Charge Current vs Temperature Profile

Assuming a 103AT NTC thermistor on the battery pack as shown in the [Figure 22](#), the value RT1 and RT2 can be determined by using [Equation 7](#) and [Equation 8](#):

$$RT2 = \frac{V_{VREF} \times R_{TH_{COOL}} \times R_{TH_{WARM}} \times \left(\frac{1}{V_{COOL}} - \frac{1}{V_{WARM}} \right)}{R_{TH_{WARM}} \times \left(\frac{V_{VREF}}{V_{WARM}} - 1 \right) - R_{TH_{COOL}} \times \left(\frac{V_{VREF}}{V_{COOL}} - 1 \right)} \quad (7)$$

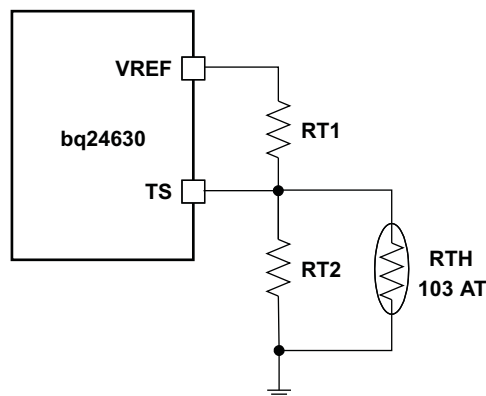
$$RT1 = \frac{\frac{V_{VREF}}{V_{COOL}} - 1}{\frac{1}{RT2} + \frac{1}{R_{TH_{COOL}}}} \quad (8)$$

Figure 18. TS Resistor Network

Feature Description (continued)

For example, a 103AT NTC thermistor is used to monitor the battery pack temperature. Select $T_{COOL} = 0^{\circ}\text{C}$, $T_{WARM} = 60^{\circ}\text{C}$. From the calculation and select standard 5% resistor value, $R_{T1} = 2.2\text{ k}\Omega$, $R_{T2} = 6.8\text{ k}\Omega$, and T_{COLD} is -17°C (target -20°C); T_{HOT} is 77°C (target 75°C), and $T_{CUT-OFF}$ is 86°C (target 80°C). A small RC filter is suggested to protect the TS pin from system-level ESD.

8.3.19 Timer Fault Recovery

The bq24630 provides a recovery method to deal with timer fault conditions. The following summarizes this method:

Condition 1: The battery voltage is above the recharge threshold and a time-out fault occurs.

Recovery Method: The timer fault clears when the battery voltage falls below the recharge threshold, and battery detection begins. Taking CE low, or a POR condition, also clears the fault.

Condition 2: The battery voltage is below the RECHARGE threshold and a time-out fault occurs.

Recovery Method: Under this scenario, the bq24630 applies the IFAULT current to the battery. This small current is used to detect a battery removal condition and remains on as long as the battery voltage stays below the recharge threshold. If the battery voltage goes above the recharge threshold, the bq24630 disables the fault current and executes the recovery method described in Condition 1. Taking CE low, or a POR condition, also clears the fault.

8.3.20 $\overline{\text{PG}}$ Output

The open drain $\overline{\text{PG}}$ (power-good) output indicates whether the VCC voltage is valid or not. The open-drain FET turns on whenever bq24630 has a valid VCC input (not in UVLO or ACOV or SLEEP mode). The PG pin can be used to drive an LED or communicate with the host processor.

8.3.21 CE (Charge Enable)

The CE digital input is used to disable or enable the charge process. A high-level signal on this pin enables charge, provided all the other conditions for charge are met (see [Enable and Disable Charging](#)). A high-to-low transition on this pin also resets all timers and fault conditions. There is an internal 1-M Ω pulldown resistor on the CE pin, so if CE is floated the charge does not turn on.

8.3.22 Charge Status Outputs

The open-drain STAT1 and STAT2 outputs indicate various charger operations as shown in [Table 2](#). These status pins can be used to drive LEDs or communicate with the host processor. Note that OFF indicates that the open-drain transistor is turned off.

Table 2. Stat Pin Definition for bq24630

CHARGE STATE	STAT1	STAT2
Charge in progress	ON	OFF
Charge complete	OFF	ON
Charge suspend, timer fault, overvoltage, sleep mode, battery absent	OFF	OFF

8.3.23 Battery Detection

For applications with removable battery packs, the bq24630 provides a battery-absent detection scheme to reliably detect the insertion or removal of battery packs.

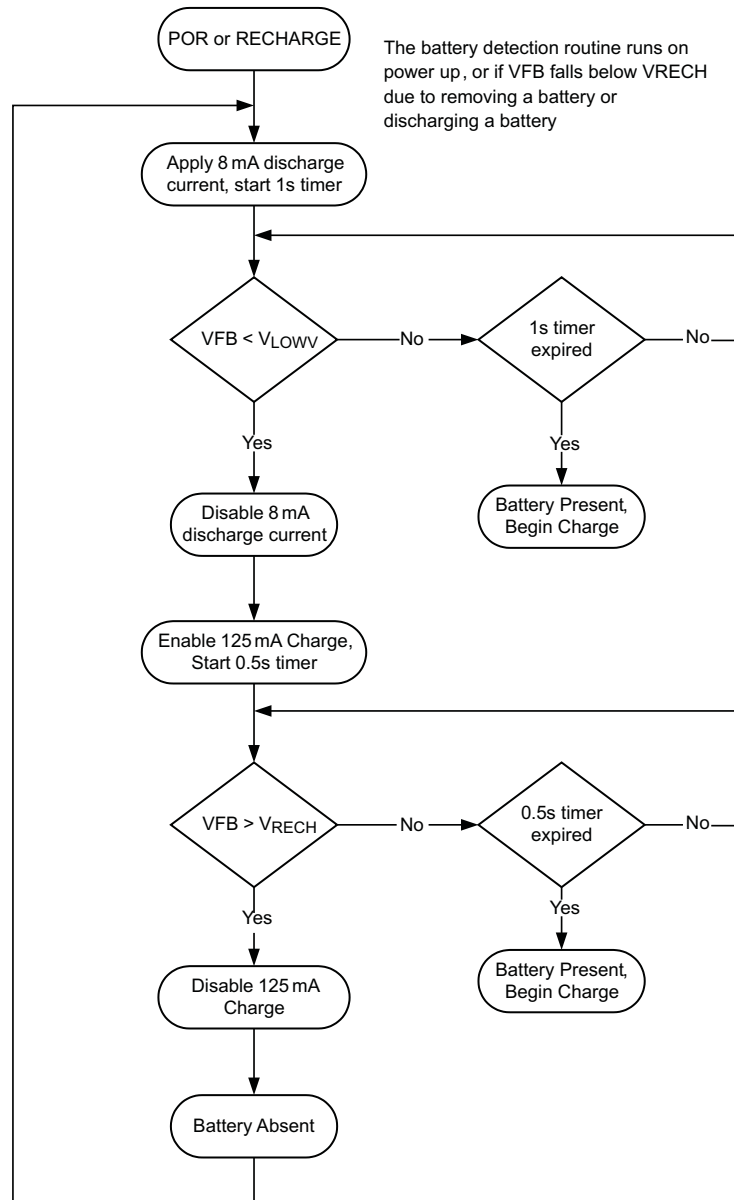

Figure 19. Battery Detection Flowchart

Once the device has powered up, an 8-mA discharge current is applied to the SRN terminal. If the battery voltage falls below the LOWV threshold within 1 second, the discharge source is turned off, and the charger is turned on at low charge current (125 mA). If the battery voltage rises above the recharge threshold within 500 ms, there is no battery present and the cycle restarts. If either the 500-ms or 1-second timer times out before the respective thresholds are hit, a battery is detected and a charge cycle is initiated.

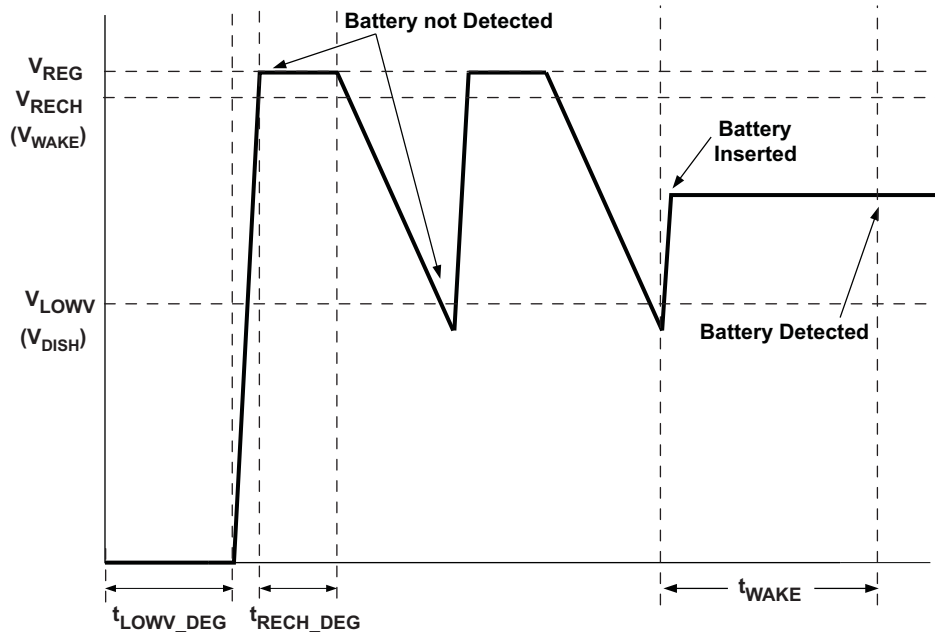

Figure 20. Battery Detect Timing Diagram

Care must be taken that the total output capacitance at the battery node is not so large that the discharge current source cannot pull the voltage below the LOWV threshold during the 1-second discharge time. The maximum output capacitance can be calculated as seen in Equation 9:

$$C_{MAX} = \frac{I_{DISCH} \times t_{DISCH}}{1.425 \times \left[1 + \frac{R_2}{R_1} \right]} \quad (9)$$

Where C_{MAX} is the maximum output capacitance, I_{DISCH} is the discharge current, t_{DISCH} is the discharge time, and R_2 and R_1 are the voltage feedback resistors from the battery to the VFB pin. The 1.425 factor is the difference between the RECHARGE and the LOWV thresholds at the VFB pin.

EXAMPLE

For a 3-cell LiFePO₄ charger, with $R_2 = 500 \text{ k}\Omega$, $R_1 = 100 \text{ k}\Omega$ (giving 10.8 V for voltage regulation), $I_{DISCH} = 8 \text{ mA}$, $t_{DISCH} = 1 \text{ second}$,

$$C_{MAX} = \frac{8\text{mA} \times 1\text{sec}}{1.425 \times \left[1 + \frac{500\text{k}}{100\text{k}} \right]} = 930 \text{ }\mu\text{F} \quad (10)$$

Based on these calculations, no more than 930 μF should be allowed on the battery node for proper operation of the battery detection circuit.

8.4 Device Functional Modes

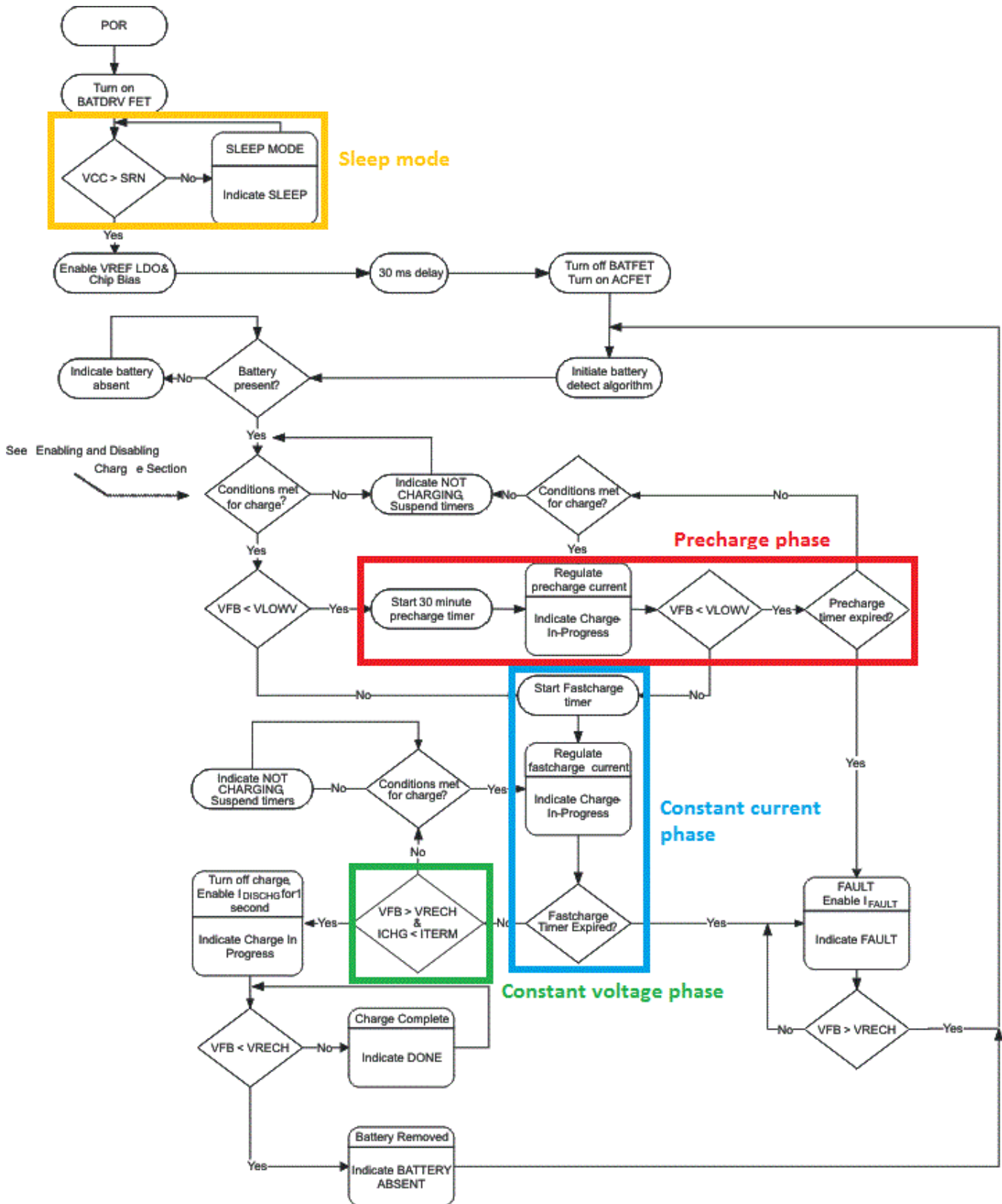

Figure 21. Device Operational Flow Chart

9 Application and Implementation

NOTE

Information in the following applications sections is not part of the TI component specification, and TI does not warrant its accuracy or completeness. TI's customers are responsible for determining suitability of components for their purposes. Customers should validate and test their design implementation to confirm system functionality.

9.1 Application Information

The bq24630 battery charger is ideal for high current charging (up to 10 A) and can charge battery packs consisting of single cells or multiple cells in series. The bq24630EVM is a complete charge module for evaluating the bq24630. The application curves were taken using the bq24630EVM. Refer to the EVM user's guide (SLUU396) for EVM information.

9.2 Typical Application

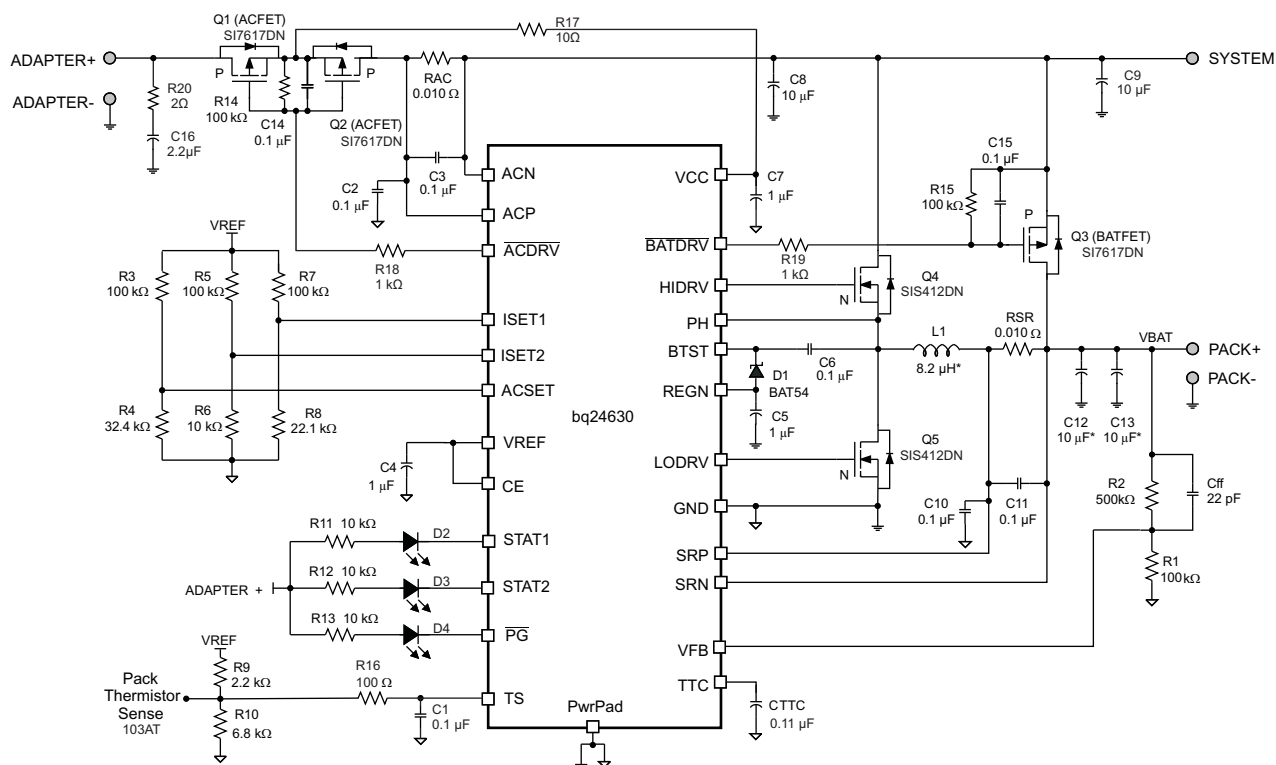

NOTE: VIN = 19 V, BAT = 3-cell LiFePO₄, I_{adapter_limit} = 4 A, I_{charge} = 3 A, I_{pre-charge} = 0.125 A, I_{term} = 0.3 A, 2.5-h safety timer

Figure 22. Typical System Schematic

9.2.1 Design Requirements

For this design example, use the parameters listed in Table 3 as the input parameters.

Table 3. Design Parameters

DESIGN PARAMETER	EXAMPLE VALUE
AC adapter voltage (VIN)	19 V
AC adapter current limit	4 A
Battery charge voltage (number of cells in series)	10.8 V (3 cells)
Battery charge current (during constant current phase)	3 A

Table 3. Design Parameters (continued)

DESIGN PARAMETER	EXAMPLE VALUE
Precharge current	0.125 A
Termination current	0.3 A
Safety timer	2.5 hours

9.2.2 Detailed Design Procedure

9.2.2.1 Inductor Selection

The bq24630 has 300-kHz switching frequency to allow the use of small inductor and capacitor values. Inductor saturation current should be higher than the charging current (I_{CHARGE}) plus half the ripple current (I_{RIPPLE}):

$$I_{\text{SAT}} \geq I_{\text{CHG}} + (1/2) I_{\text{RIPPLE}} \quad (11)$$

The inductor ripple current depends on input voltage (V_{IN}), duty cycle ($D = V_{\text{OUT}}/V_{\text{IN}}$), switching frequency (f_s) and inductance (L):

$$I_{\text{RIPPLE}} = \frac{V_{\text{IN}} \times D \times (1 - D)}{f_s \times L} \quad (12)$$

The maximum inductor ripple current happens with $D = 0.5$. For example, the battery charging voltage range is from 2.8 V to 14.4 V for a 4-cell battery pack. For 20-V adapter voltage, 10-V battery voltage gives the maximum inductor ripple current.

Usually, inductor ripple is designed in the range of 20%–40% of maximum charging current as a trade-off between inductor size and efficiency for a practical design.

The bq24630 has cycle-by-cycle charge undercurrent protection (UCP) by monitoring the charge-current sensing resistor to prevent negative inductor current. The typical UCP threshold is 5 mV falling edge, corresponding to 0.5-A falling edge for a 10-m Ω charge-current sensing resistor.

9.2.2.2 Input Capacitor

Input capacitor should have enough ripple-current rating to absorb the input switching-ripple current. The worst-case RMS ripple current is half of the charging current when the duty cycle is 0.5. If the converter does not operate at 50% duty cycle, then the worst-case capacitor rms current I_{CIN} occurs where the duty cycle is closest to 50% and can be estimated by the following equation:

$$I_{\text{CIN}} = I_{\text{CHG}} \times \sqrt{D \times (1-D)} \quad (13)$$

A low-ESR ceramic capacitor such as X7R or X5R is preferred for the input decoupling capacitor and should be placed as close as possible to the drain of the high-side MOSFET and source of the low-side MOSFET. The voltage rating of the capacitor must be higher than the normal input voltage level. A 25-V rating or higher capacitor is preferred for 20-V input voltage. A 20- μF capacitance is suggested for typical of 3-A to 4-A charging current.

9.2.2.3 Output Capacitor

Output capacitor also should have enough ripple current rating to absorb output switching ripple current. The output capacitor RMS current I_{COUT} is given:

$$I_{\text{COUT}} = \frac{I_{\text{RIPPLE}}}{2 \times \sqrt{3}} \approx 0.29 \times I_{\text{RIPPLE}} \quad (14)$$

The output capacitor voltage ripple can be calculated as follows:

$$\Delta V_o = \frac{1}{8LCf_s^2} \left(V_{\text{BAT}} - \frac{V_{\text{BAT}}^2}{V_{\text{IN}}} \right) \quad (15)$$

At certain input/output voltage and switching frequency, the voltage ripple can be reduced by increasing the output filter LC.

The bq24630 has internal loop compensator. To get good loop stability, the resonant frequency of the output inductor and output capacitor should be designed between 10 kHz and 15 kHz. The preferred ceramic capacitor is 25 V, X7R or X5R for 4-cell applications.

9.2.2.4 Power MOSFET Selection

Two external N-channel MOSFETs are used for a synchronous switching battery charger. The gate drivers are internally integrated into the IC with 6 V of gate drive voltage. 30-V or higher voltage rating MOSFETs are preferred for a 20-V input voltage and 40-V MOSFETs are preferred for 20-V to 28-V input voltage.

Figure of merit (FOM) is usually used for selecting the proper MOSFET based on a tradeoff between the conduction loss and switching loss. For a top-side MOSFET, FOM is defined as the product of a MOSFET on-resistance, $r_{DS(on)}$, and the gate-to-drain charge, Q_{GD} . For a bottom-side MOSFET, FOM is defined as the product of the MOSFET on-resistance, $r_{DS(on)}$, and the total gate charge, Q_G .

$$FOM_{top} = R_{DS(on)} \times Q_{GD} \quad FOM_{bottom} = R_{DS(on)} \times Q_G \quad (16)$$

The lower the FOM value, the lower the total power loss. Usually, lower $r_{DS(on)}$ has higher cost with the same package size.

The top-side MOSFET loss includes conduction loss and switching loss. It is a function of duty cycle ($D = V_{OUT}/V_{IN}$), charging current (I_{CHARGE}), MOSFET on-resistance ($r_{DS(on)}$), input voltage (V_{IN}), switching frequency (f_s), turnon time (t_{on}) and turnoff time (t_{off}):

$$P_{top} = D \times I_{CHG}^2 \times R_{DS(on)} + \frac{1}{2} \times V_{IN} \times I_{CHG} \times (t_{on} + t_{off}) \times f_s \quad (17)$$

The first item represents the conduction loss. Usually, MOSFET $r_{DS(on)}$ increases by 50% with a 100°C junction temperature rise. The second term represents the switching loss. The MOSFET turnon and turnoff times are given by:

$$t_{on} = \frac{Q_{SW}}{I_{on}}, \quad t_{off} = \frac{Q_{SW}}{I_{off}} \quad (18)$$

where Q_{SW} is the switching charge, I_{on} is the turnon gate-driving current, and I_{off} is the turnoff gate-driving current. If the switching charge is not given in the MOSFET datasheet, it can be estimated by gate-to-drain charge (Q_{GD}) and gate-to-source charge (Q_{GS}):

$$Q_{SW} = Q_{GD} + \frac{1}{2} \times Q_{GS} \quad (19)$$

Total gate-driving current can be estimated by the REGN voltage (V_{REGN}), MOSFET plateau voltage (V_{plt}), total turnon gate resistance (R_{on}), and turnoff gate resistance (R_{off}) of the gate driver:

$$I_{on} = \frac{V_{REGN} - V_{plt}}{R_{on}}, \quad I_{off} = \frac{V_{plt}}{R_{off}} \quad (20)$$

The conduction loss of the bottom-side MOSFET is calculated with the following equation when it operates in synchronous continuous conduction mode:

$$P_{bottom} = (1 - D) \times I_{CHG}^2 \times R_{DS(on)} \quad (21)$$

If the SRP-SRN voltage decreases below 5 mV (the charger is also forced into non-synchronous mode when the average SRP-SRN voltage is lower than 1.25 mV), the low-side FET is turned off for the remainder of the switching cycle to prevent negative inductor current.

As a result, all the freewheeling current goes through the body diode of the bottom-side MOSFET. The maximum charging current in non-synchronous mode can be up to 0.9 A (0.5 A typ.) for a 10-mΩ charging-current sensing resistor, considering IC tolerance. Choose the bottom-side MOSFET with either an internal Schottky or body diode capable of carrying the maximum non-synchronous mode charging current.

MOSFET gate driver power loss contributes to the dominant losses on the controller IC when the buck converter is switching. Choosing a MOSFET with a small Q_{g_total} reduces the IC power loss to avoid thermal shutdown.

$$P_{ICLoss_driver} = V_{IN} \cdot Q_{g_total} \cdot f_s \quad (22)$$

where Q_{g_total} is the total gate charge for both upper and lower MOSFET at 6-V V_{REGN} .

The V_{REF} load current is another component of the VCC input current (Do not overload V_{REF} .), where total IC loss can be described by following equations:

$$P_{VREF} = (V_{IN} - V_{VREF}) \cdot I_{VREF}$$

$$P_{ICLOSS} = P_{ICLOSS_driver} + P_{VREF} + P_{Quiescent} \quad (23)$$

9.2.2.5 Input Filter Design

During adapter hot plug-in, the parasitic inductance and input capacitor from the adapter cable form a second-order system. The voltage spike at the VCC pin may be beyond the IC maximum voltage rating and damage the IC. The input filter must be carefully designed and tested to prevent an overvoltage event on the VCC pin. The ACP/ACN pin must be placed after the input ACFETs in order to avoid overvoltage stress and high dv/dt during hot plug-in.

There are several methods for damping or limiting the overvoltage spike during adapter hot plug-in. An electrolytic capacitor with high ESR as an input capacitor can damp the overvoltage spike well below the IC maximum pin voltage rating. A high-current-capability TVS Zener diode can also limit the overvoltage level to an IC-safe level. However, these two solutions may not have low cost or small size.

A cost-effective and small-size solution is shown in [Figure 23](#). R1 and C1 comprise a damping RC network to damp the hot plug-in oscillation. As a result, the overvoltage spike is limited to a safe level. D1 is used for reverse voltage protection for the VCC pin (it can be the body diode of input ACFET). C2 is VCC pin-decoupling capacitor and it should be placed as close as possible to the VCC pin. R2 and C2 form a damping RC network to further protect the IC from high-dv/dt and high-voltage spikes. The C2 value should be less than the C1 value so R1 can be dominant over the ESR of C1 to get enough damping effect for hot plug-in. The R1 and R2 packages must be sized to handle static current and inrush current power loss according to the resistor manufacturer's datasheet. The values of filter components always must be verified with the real application, and minor adjustments may be needed to fit in the real application circuit.

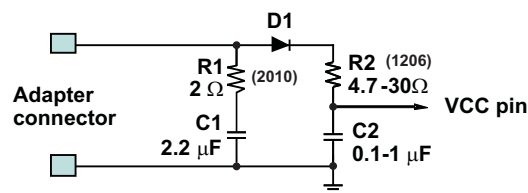

Figure 23. Input Filter

9.2.2.6 Inductor, Capacitor, and Sense Resistor Selection Guidelines

The bq24630 provides internal loop compensation. With this scheme, best stability occurs when the LC resonant frequency, f_o , is approximately 10 kHz to 15 kHz per [Equation 24](#):

$$f_o = \frac{1}{2\pi\sqrt{L_o C_o}} \quad (24)$$

[Table 4](#) provides a summary of typical LC components for various charge currents

Table 4. Typical Inductor, Capacitor, and Sense Resistor Values as a Function of Charge Current

CHARGE CURRENT	2 A	4 A	6 A	8 A	10 A
Output Inductor L_o	8.2 μ H	8.2 μ H	5.6 μ H	4.7 μ H	4.7 μ H
Output capacitor C_o	20 μ F	20 μ F	30 μ F	40 μ F	40 μ F
Sense resistor	10 m Ω	10 m Ω	10 m Ω	10 m Ω	10 m Ω

9.2.2.7 Typical System Circuit Component List

The following table lists the components for the typical system circuit in [Figure 22](#).

PART DESIGNATOR	QTY	DESCRIPTION
Q1, Q2, Q3	3	P-channel MOSFET, -30 V, -35 A, PowerPAK 1212-8, Vishay-Siliconix, Si7617DN
Q4, Q5	2	N-channel MOSFET, 30 V, 12 A, PowerPAK 1212-8, Vishay-Siliconix, Sis412DN
D1	1	Diode, dual Schottky, 30 V, 200 mA, SOT23, Fairchild, BAT54C
D2, D3, D4	3	LED diode, green, 2.1 V, 20 mA, LTST-C190GKT
R _{AC} , R _{SR}	2	Sense resistor, 10 mΩ, 2010, Vishay-Dale, WSL2010R0100F
L1	1	Inductor, 6.8 μH, 5.5 A, Vishay-Dale IHLP2525CZ
C2, C10	2	Capacitor, ceramic, 0.1 μF, 50 V, 10%, X7R
C7	1	Capacitor, ceramic, 1 μF, 50 V, 10%, X7R
C8, C9, C12, C13	4	Capacitor, ceramic, 10 μF, 35 V, 20%, X7R
C4, C5	2	Capacitor, ceramic, 1 μF, 25 V, 10%, X7R
C1, C3, C6, C11	4	Capacitor, ceramic, 0.1 μF, 16 V, 10%, X7R
C14, C15 (Optional)	2	Capacitor, ceramic, 0.1 μF, 50 V, 10%, X7R
C16	1	Capacitor, ceramic, 2.2 μF, 35 V, 10%, X7R
C _{ff}	1	Capacitor, ceramic, 22 pF, 25 V, 10%, X7R
C _{TTC}	1	Capacitor, ceramic, 0.11 μF, 25 V, 5%, X7R
R1, R3, R5, R7	4	Resistor, chip, 100 kΩ, 1/16W, 0.5%
R2	1	Resistor, Chip, 500 kΩ, 1/16W, 0.5%
R4	1	Resistor, chip, 32.4 kΩ, 1/16W, 0.5%
R6	1	Resistor, chip, 10 kΩ, 1/16W, 0.5%
R8	1	Resistor, chip, 22.1 kΩ, 1/16W, 0.5%
R9	1	Resistor, chip, 2.2 kΩ, 1/16W, 5%
R10	1	Resistor, chip, 6.8 kΩ, 1/16W, 5%
R11, R12, R13	3	Resistor, chip, 10 kΩ, 1/16W, 5%
R14, R15 (optional)	2	Resistor, chip, 100 kΩ, 1/16W, 5%
R16	1	Resistor, chip, 100 Ω, 1/16W, 5%
R17	1	Resistor, chip, 10 Ω, 1/4W, 5%
R18, R19	2	Resistor, chip, 1 kΩ, 1/16W, 5%
R20	1	Resistor, chip, 2 Ω, 1W, 5%

9.2.3 Application Curves

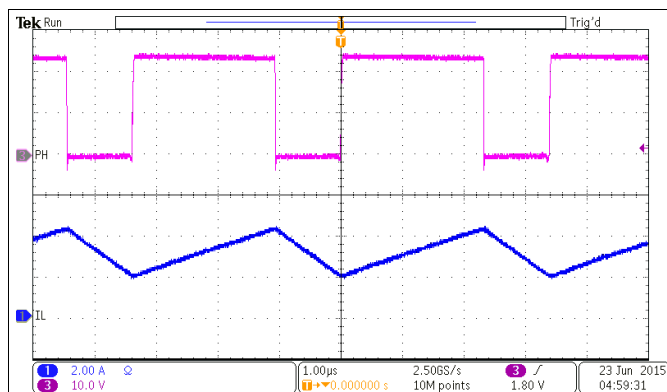

Figure 24. Continuous Conduction Mode Switching Waveform

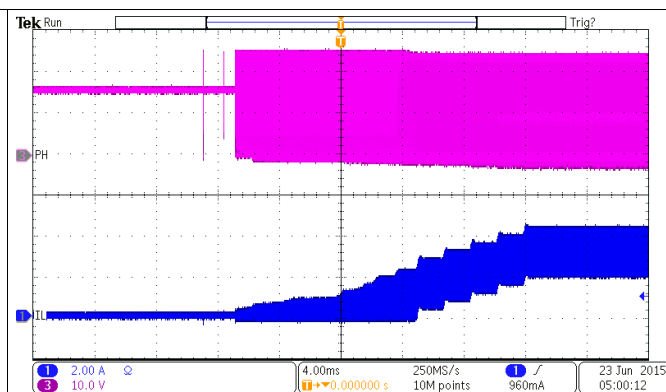

Figure 25. Battery Charging Soft Start

10 Power Supply Recommendations

For proper operation of bq24630, VCC must be from 5 V to 28 V. To begin charging, VCC must be higher than SRN by at least 500 mV (otherwise, the device will be in sleep mode). TI recommends an input voltage of at least 1.5 V to 2 V higher than the battery voltage, taking into consideration the DC losses in the high-side FET ($R_{ds(on)}$), inductor (DCR), and input sense resistor (between ACP and ACN), the body diode drop of RBFET between VCC and input power supply, and battery sense resistor (between SRP and SRN). Power limit for the input supply must be greater than the maximum power required by either the system load or for battery charging (the greater of the two).

11 Layout

11.1 Layout Guidelines

The switching node rise and fall times should be minimized for minimum switching loss. Proper layout of the components to minimize the high-frequency current path loop (see [Figure 26](#)) is important to prevent electrical and magnetic field radiation and high-frequency resonance problems. Here is a PCB layout priority list for proper layout. Layout of the PCB according to this specific order is essential.

1. Place the input capacitor as close as possible to switching the MOSFET supply and ground connections and use the shortest possible copper trace connection. These parts should be placed on the same layer of PCB instead of on different layers using vias to make this connection.
2. The IC should be placed close to the switching MOSFET gate terminals, keeping the gate-drive signal traces short for a clean MOSFET drive. The IC can be placed on the other side of the PCB from the switching MOSFETs.
3. Place the inductor input terminal as close as possible to the switching MOSFET output terminal. Minimize the copper area of this trace to lower electrical and magnetic field radiation, but make the trace wide enough to carry the charging current. Do not use multiple layers in parallel for this connection. Minimize parasitic capacitance from this area to any other trace or plane.
4. The charging-current sensing resistor should be placed right next to the inductor output. Route the sense leads connected across the sensing resistor back to the IC in the same layer, close to each other (minimize loop area), and do not route the sense leads through a high-current path (see [Figure 27](#) for Kelvin connection for best current accuracy). Place a decoupling capacitor on these traces next to the IC.
5. Place the output capacitor next to the sensing resistor output and ground.
6. Output capacitor ground connections must be tied to the same copper that connects to the input capacitor ground before connecting to system ground.
7. Route the analog ground separately from the power ground and use a single ground connection to tie the charger power ground to the charger analog ground. Just beneath the IC, use the copper pour for analog ground, but avoid power pins to reduce inductive and capacitive noise coupling. Connect the analog ground to GND. Connect the analog ground and power ground together using the power pad as the single ground connection point. Or use a 0- Ω resistor to tie the analog ground to power ground (the thermal pad should tie to analog ground in this case). A star-connection under the thermal pad is highly recommended.
8. It is critical that the exposed thermal pad on the backside of the IC package be soldered to the PCB ground. Ensure that there are sufficient thermal vias directly under the IC connecting to the ground plane on the other layers.
9. Decoupling capacitors should be placed next to the IC pins; make the trace connections as short as possible.
10. All via sizes and numbers should be adequate for a given current path.

See the EVM design ([SLUU396](#)) for recommended component placement of trace and via locations.

For VQFN information, see [SCBA017](#) and [SLUA271](#).

11.2 Layout Example

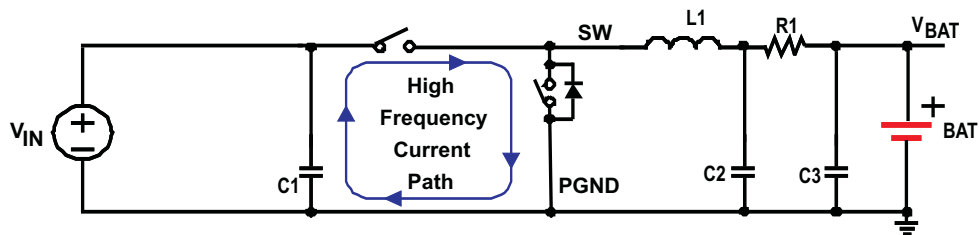

Figure 26. High Frequency Current Path

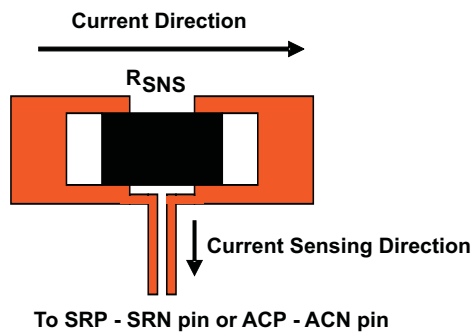

Figure 27. Sensing Resistor PCB Layout

12 Device and Documentation Support

12.1 Device Support

12.1.1 Third-Party Products Disclaimer

TI'S PUBLICATION OF INFORMATION REGARDING THIRD-PARTY PRODUCTS OR SERVICES DOES NOT CONSTITUTE AN ENDORSEMENT REGARDING THE SUITABILITY OF SUCH PRODUCTS OR SERVICES OR A WARRANTY, REPRESENTATION OR ENDORSEMENT OF SUCH PRODUCTS OR SERVICES, EITHER ALONE OR IN COMBINATION WITH ANY TI PRODUCT OR SERVICE.

12.2 Documentation Support

12.2.1 Related Documentation

[bq2461x/bq2463x EVM \(HPA422\) Multi-Cell Synchronous Switch-Mode Charger EVM User's Guide \(SLUU396\)](#)

[Quad Flatpack No-Lead Logic Packages Application Report \(SCBA017\)](#)

[QFN/SON PCB Attachment Application Report \(SLUA271\)](#)

12.3 Community Resources

The following links connect to TI community resources. Linked contents are provided "AS IS" by the respective contributors. They do not constitute TI specifications and do not necessarily reflect TI's views; see TI's [Terms of Use](#).

TI E2E™ Online Community *TI's Engineer-to-Engineer (E2E) Community*. Created to foster collaboration among engineers. At e2e.ti.com, you can ask questions, share knowledge, explore ideas and help solve problems with fellow engineers.

Design Support *TI's Design Support* Quickly find helpful E2E forums along with design support tools and contact information for technical support.

12.4 Trademarks

E2E is a trademark of Texas Instruments.
All other trademarks are the property of their respective owners.

12.5 Electrostatic Discharge Caution



These devices have limited built-in ESD protection. The leads should be shorted together or the device placed in conductive foam during storage or handling to prevent electrostatic damage to the MOS gates.

12.6 Glossary

[SLYZ022](#) — *TI Glossary*.

This glossary lists and explains terms, acronyms, and definitions.

13 Mechanical, Packaging, and Orderable Information

The following pages include mechanical, packaging, and orderable information. This information is the most current data available for the designated devices. This data is subject to change without notice and revision of this document. For browser-based versions of this data sheet, refer to the left-hand navigation.

PACKAGING INFORMATION

Orderable Device	Status (1)	Package Type	Package Drawing	Pins	Package Qty	Eco Plan (2)	Lead/Ball Finish (6)	MSL Peak Temp (3)	Op Temp (°C)	Device Marking (4/5)	Samples
BQ24630RGER	ACTIVE	VQFN	RGE	24	3000	Green (RoHS & no Sb/Br)	NIPDAU	Level-2-260C-1 YEAR	-40 to 85	OAT	Samples
BQ24630RGET	ACTIVE	VQFN	RGE	24	250	Green (RoHS & no Sb/Br)	NIPDAU	Level-2-260C-1 YEAR	-40 to 85	OAT	Samples

(1) The marketing status values are defined as follows:

ACTIVE: Product device recommended for new designs.

LIFEBUY: TI has announced that the device will be discontinued, and a lifetime-buy period is in effect.

NRND: Not recommended for new designs. Device is in production to support existing customers, but TI does not recommend using this part in a new design.

PREVIEW: Device has been announced but is not in production. Samples may or may not be available.

OBsolete: TI has discontinued the production of the device.

(2) **RoHS:** TI defines "RoHS" to mean semiconductor products that are compliant with the current EU RoHS requirements for all 10 RoHS substances, including the requirement that RoHS substance do not exceed 0.1% by weight in homogeneous materials. Where designed to be soldered at high temperatures, "RoHS" products are suitable for use in specified lead-free processes. TI may reference these types of products as "Pb-Free".

RoHS Exempt: TI defines "RoHS Exempt" to mean products that contain lead but are compliant with EU RoHS pursuant to a specific EU RoHS exemption.

Green: TI defines "Green" to mean the content of Chlorine (Cl) and Bromine (Br) based flame retardants meet JS709B low halogen requirements of <=1000ppm threshold. Antimony trioxide based flame retardants must also meet the <=1000ppm threshold requirement.

(3) MSL, Peak Temp. - The Moisture Sensitivity Level rating according to the JEDEC industry standard classifications, and peak solder temperature.

(4) There may be additional marking, which relates to the logo, the lot trace code information, or the environmental category on the device.

(5) Multiple Device Markings will be inside parentheses. Only one Device Marking contained in parentheses and separated by a "-" will appear on a device. If a line is indented then it is a continuation of the previous line and the two combined represent the entire Device Marking for that device.

(6) Lead/Ball Finish - Orderable Devices may have multiple material finish options. Finish options are separated by a vertical ruled line. Lead/Ball Finish values may wrap to two lines if the finish value exceeds the maximum column width.

Important Information and Disclaimer:The information provided on this page represents TI's knowledge and belief as of the date that it is provided. TI bases its knowledge and belief on information provided by third parties, and makes no representation or warranty as to the accuracy of such information. Efforts are underway to better integrate information from third parties. TI has taken and continues to take reasonable steps to provide representative and accurate information but may not have conducted destructive testing or chemical analysis on incoming materials and chemicals. TI and TI suppliers consider certain information to be proprietary, and thus CAS numbers and other limited information may not be available for release.

In no event shall TI's liability arising out of such information exceed the total purchase price of the TI part(s) at issue in this document sold by TI to Customer on an annual basis.

TAPE AND REEL INFORMATION



QUADRANT ASSIGNMENTS FOR PIN 1 ORIENTATION IN TAPE



*All dimensions are nominal

Device	Package Type	Package Drawing	Pins	SPQ	Reel Diameter (mm)	Reel Width W1 (mm)	A0 (mm)	B0 (mm)	K0 (mm)	P1 (mm)	W (mm)	Pin1 Quadrant
BQ24630RGER	VQFN	RGE	24	3000	330.0	12.4	4.25	4.25	1.15	8.0	12.0	Q2
BQ24630RGET	VQFN	RGE	24	250	180.0	12.4	4.25	4.25	1.15	8.0	12.0	Q2

TAPE AND REEL BOX DIMENSIONS

*All dimensions are nominal

Device	Package Type	Package Drawing	Pins	SPQ	Length (mm)	Width (mm)	Height (mm)
BQ24630RGER	VQFN	RGE	24	3000	367.0	367.0	35.0
BQ24630RGET	VQFN	RGE	24	250	210.0	185.0	35.0

RGE 24

GENERIC PACKAGE VIEW

VQFN - 1 mm max height

PLASTIC QUAD FLATPACK - NO LEAD



Images above are just a representation of the package family, actual package may vary.
Refer to the product data sheet for package details.

4204104/H



4219013/A 05/2017

NOTES:

1. All linear dimensions are in millimeters. Any dimensions in parenthesis are for reference only. Dimensioning and tolerancing per ASME Y14.5M.
2. This drawing is subject to change without notice.
3. The package thermal pad must be soldered to the printed circuit board for thermal and mechanical performance.

EXAMPLE BOARD LAYOUT

RGE0024B

VQFN - 1 mm max height

PLASTIC QUAD FLATPACK - NO LEAD

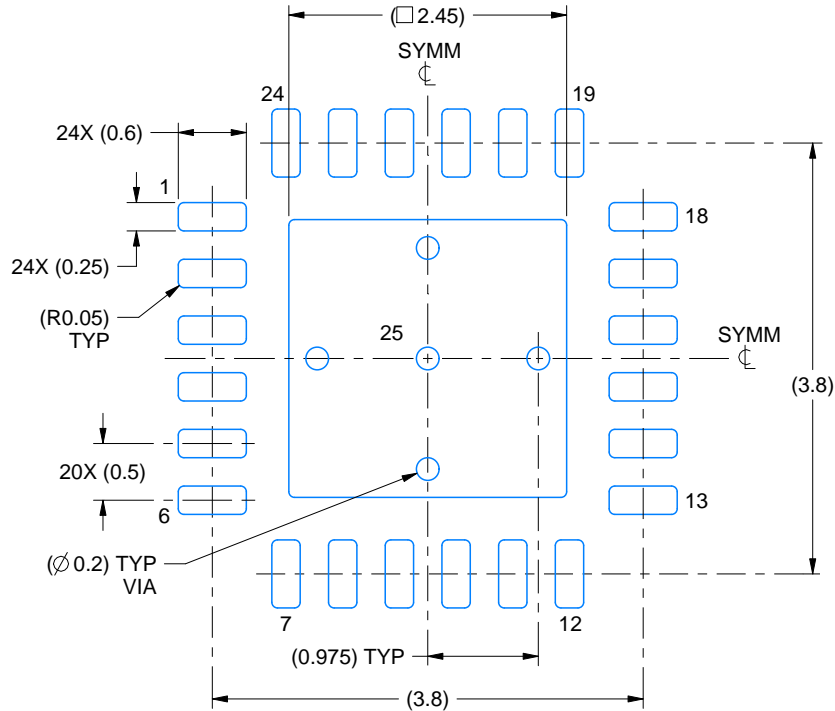

LAND PATTERN EXAMPLE
EXPOSED METAL SHOWN
SCALE:15X

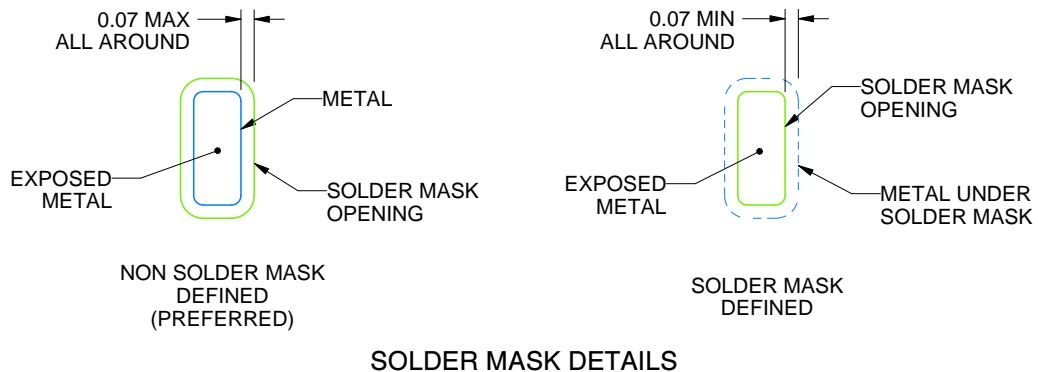

SOLDER MASK DETAILS

4219013/A 05/2017

NOTES: (continued)

- This package is designed to be soldered to a thermal pad on the board. For more information, see Texas Instruments literature number SLUA271 (www.ti.com/lit/slua271).
- Vias are optional depending on application, refer to device data sheet. If any vias are implemented, refer to their locations shown on this view. It is recommended that vias under paste be filled, plugged or tented.

EXAMPLE STENCIL DESIGN

RGE0024B

VQFN - 1 mm max height

PLASTIC QUAD FLATPACK - NO LEAD



SOLDER PASTE EXAMPLE
 BASED ON 0.125 mm THICK STENCIL

EXPOSED PAD 25
 78% PRINTED SOLDER COVERAGE BY AREA UNDER PACKAGE
 SCALE:20X

4219013/A 05/2017

NOTES: (continued)

- 6. Laser cutting apertures with trapezoidal walls and rounded corners may offer better paste release. IPC-7525 may have alternate design recommendations.

IMPORTANT NOTICE AND DISCLAIMER

TI PROVIDES TECHNICAL AND RELIABILITY DATA (INCLUDING DATASHEETS), DESIGN RESOURCES (INCLUDING REFERENCE DESIGNS), APPLICATION OR OTHER DESIGN ADVICE, WEB TOOLS, SAFETY INFORMATION, AND OTHER RESOURCES "AS IS" AND WITH ALL FAULTS, AND DISCLAIMS ALL WARRANTIES, EXPRESS AND IMPLIED, INCLUDING WITHOUT LIMITATION ANY IMPLIED WARRANTIES OF MERCHANTABILITY, FITNESS FOR A PARTICULAR PURPOSE OR NON-INFRINGEMENT OF THIRD PARTY INTELLECTUAL PROPERTY RIGHTS.

These resources are intended for skilled developers designing with TI products. You are solely responsible for (1) selecting the appropriate TI products for your application, (2) designing, validating and testing your application, and (3) ensuring your application meets applicable standards, and any other safety, security, or other requirements. These resources are subject to change without notice. TI grants you permission to use these resources only for development of an application that uses the TI products described in the resource. Other reproduction and display of these resources is prohibited. No license is granted to any other TI intellectual property right or to any third party intellectual property right. TI disclaims responsibility for, and you will fully indemnify TI and its representatives against, any claims, damages, costs, losses, and liabilities arising out of your use of these resources.

TI's products are provided subject to TI's Terms of Sale (www.ti.com/legal/termsofsale.html) or other applicable terms available either on ti.com or provided in conjunction with such TI products. TI's provision of these resources does not expand or otherwise alter TI's applicable warranties or warranty disclaimers for TI products.

Mailing Address: Texas Instruments, Post Office Box 655303, Dallas, Texas 75265
Copyright © 2020, Texas Instruments Incorporated