



## SERIES: PQD6-D | DESCRIPTION: DC-DC CONVERTER

### FEATURES

- up to 6 W isolated output
- smaller package
- 4:1 input range (9~36 V, 18~75 V)
- single/dual regulated output
- 1,500 Vdc isolation
- continuous short circuit, over current protection
- six-sided shielded case
- temperature range (-40~85°C)
- high efficiency at light load
- efficiency up to 88%



MODEL	input voltage		output voltage (Vdc)	output current		output power max (W)	ripple and noise <sup>1</sup> max (mVp-p)	efficiency typ (%)
	typ (Vdc)	range (Vdc)		min (mA)	max (mA)			
PQD6-Q24-S3-D	24	9~36	3.3	75	1500	5	75	79
PQD6-Q24-S5-D	24	9~36	5	60	1200	6	75	83
PQD6-Q24-S12-D	24	9~36	12	25	500	6	75	87
PQD6-Q24-S15-D	24	9~36	15	20	400	6	75	88
PQD6-Q24-S24-D	24	9~36	24	12	250	6	75	88
PQD6-Q24-D5-D	24	9~36	±5	±30	±600	6	75	83
PQD6-Q24-D12-D	24	9~36	±12	±12	±250	6	75	87
PQD6-Q24-D15-D	24	9~36	±15	±10	±200	6	75	88
PQD6-Q48-S3-D	48	18~75	3.3	75	1500	5	75	79
PQD6-Q48-S5-D	48	18~75	5	60	1200	6	75	83
PQD6-Q48-S12-D	48	18~75	12	25	500	6	75	87
PQD6-Q48-S15-D	48	18~75	15	20	400	6	75	88
PQD6-Q48-S24-D	48	18~75	24	12	250	6	75	88
PQD6-Q48-D5-D	48	18~75	±5	±30	±600	6	75	83
PQD6-Q48-D12-D	48	18~75	±12	±12	±250	6	75	87
PQD6-Q48-D15-D	48	18~75	±15	±10	±200	6	75	88

Notes: 1. ripple and noise are measured at 20 MHz BW by "parallel cable" method

### PART NUMBER KEY

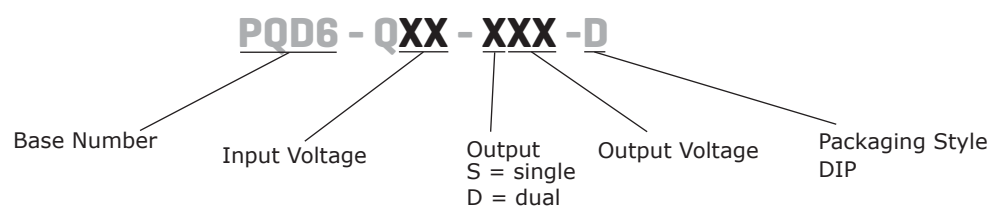

## INPUT

parameter	conditions/description	min	typ	max	units
operating input voltage	24 V input models	9	24	36	Vdc
	48 V input models	18	48	75	Vdc
start-up voltage	24 V input models			9	Vdc
	48 V input models			18	Vdc
surge voltage	for maximum of 1 second				
	24 V input models	-0.7		50	Vdc
	48 V input models	-0.7		100	Vdc
filter	pi filter				
no-load power consumption			0.15	0.3	W

## OUTPUT

parameter	conditions/description	min	typ	max	units
line regulation	full load, input voltage from low to high		±0.2	±0.5	%
load regulation	5% to 100% load		±0.5	±1	%
cross regulation	dual output				
	main output 50% load, secondary output 10%-100% load			±5	%
voltage accuracy			±1	±2	%
voltage balance <sup>1</sup>	dual output, balanced loads		±0.5	±1.5	%
switching frequency			300		KHz
transient recovery time	25% load step change		300	500	µs
transient response deviation	25% load step change		±3	±5	%
temperature coefficient	100% load			±0.03	%/°C

Note: 1. For dual output models, unbalanced load can not exceed ±5%. If ±5% is exceeded, it may not meet all specifications.

## PROTECTIONS

parameter	conditions/description	min	typ	max	units
short circuit protection	continuous, automatic recovery				
over current protection		120		180	%Io
over voltage protection		110		140	%Vo

## SAFETY AND COMPLIANCE

parameter	conditions/description	min	typ	max	units
isolation voltage	for 1 minute at 1 mA max.	1,500			Vdc
isolation resistance	at 500 Vdc	1,000			MΩ
isolation capacitance	input to output, 100 KHz/0.1 V		1,000		pF
safety approvals	CE				
conducted emissions	CISPR22/EN55022, class A, class B (external circuit required, see Figure 1-b)				
radiated emissions	CISPR22/EN55022, class A, class B (external circuit required, see Figure 1-b)				
ESD	IEC/EN61000-4-2, class B, contact ± 4kV				
radiated immunity	IEC/EN61000-4-3, class A, 10V/m				
EFT/burst	IEC/EN61000-4-4, class B, ± 2kV (external circuit required, see Figure 1-a)				
surge	IEC/EN61000-4-5, class B, ± 2kV (external circuit required, see Figure 1-a)				
conducted immunity	IEC/EN61000-4-6, class A, 3 Vr.m.s				
voltage dips & interruptions	IEC/EN61000-4-29, class B, 0%-70%				
MTBF	as per MIL-HDBK-217F @ 25°C	1,000,000			hours
RoHS compliant	2011/65/EU				

## ENVIRONMENTAL

parameter	conditions/description	min	typ	max	units
operating temperature	see derating curve	-40		85	°C
storage temperature		-55		125	°C
storage humidity	non-condensing	5		95	%
case temperature	at full load, Ta=71°C			105	°C
vibration	10~55 Hz for 30 min. along X, Y, and Z axis		10		G

## SOLDERABILITY

parameter	conditions/description	min	typ	max	units
hand soldering	1.5 mm from case for 10 seconds			300	°C
wave soldering	see wave soldering profile			260	°C

## MECHANICAL

parameter	conditions/description	min	typ	max	units
dimensions	25.40 x 25.40 x 11.70 (1.00 x 1.00 x 0.461 inch)				mm
case material	aluminum alloy				
weight			14		g

## MECHANICAL DRAWING

units: mm[inch]

tolerance: ±0.25[±0.010]

pin diameter tolerance: ±0.10[±0.004]

pin height tolerance: ±0.50[±0.020]

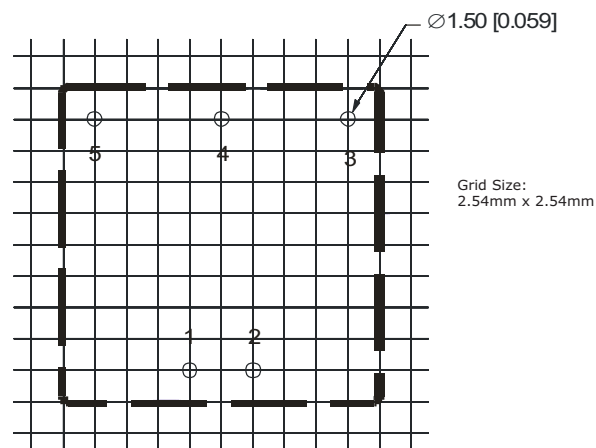
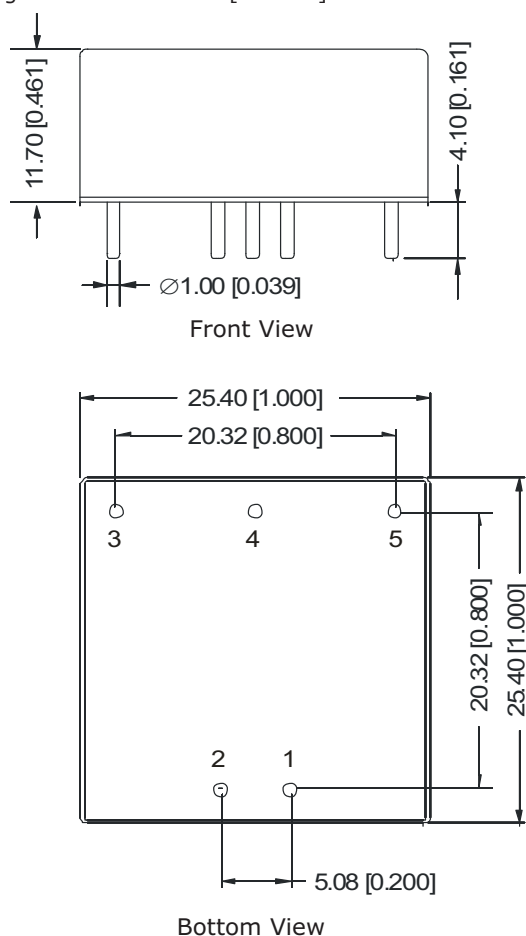

PCB Layout  
Top View

PIN CONNECTIONS		
PIN	Single Output	Dual Output
1	GND	GND
2	Vin	Vin
3	+Vo	+Vo
4	NO PIN	0V
5	0V	-Vo

## DERATING CURVES

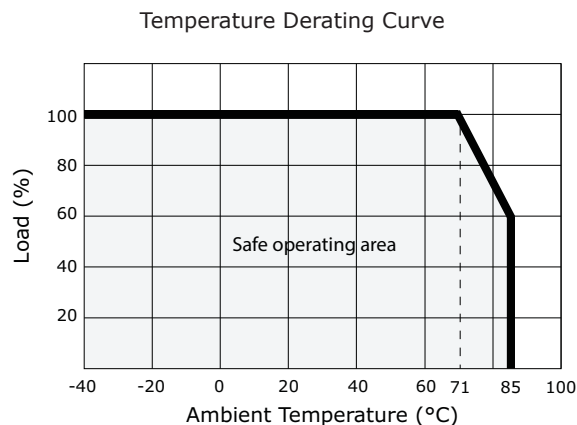
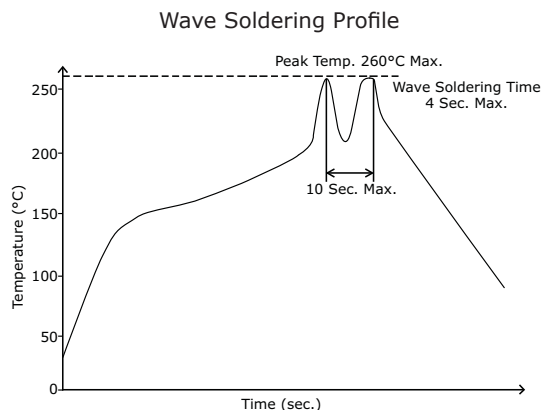

## EMC RECOMMENDED CIRCUIT

Figure 1

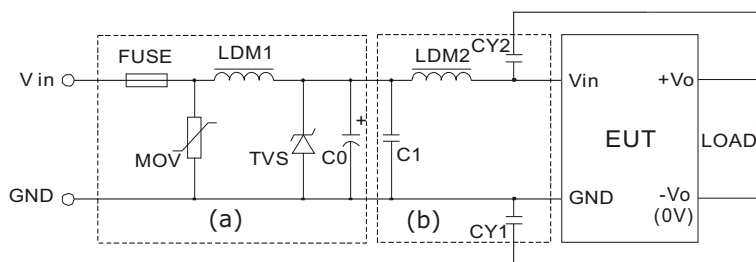

Table 1

Recommended external circuit components		
Vin (Vdc)	24	48
FUSE	choose according to practical input current	
MOV	10D560K	10D101K
LDM1	56μH	56μH
TVS	SMCJ48A	SMCJ90A
C0	120μF/50V	120μF/100V
C1	225K/50V	225K/100V
LDM2	4.7μH	4.7μH
CY1	102K/2000V	102K/2000V
CY2	102K/2000V	102K/2000V

## TEST CONFIGURATION

Figure 2

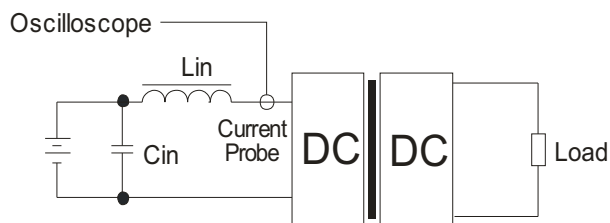

Table 2

External components	
Lin	4.7μH
Cin	220μF, ESR < 1.0Ω at 100 KHz

Note: Input reflected-ripple current is measured with an inductor Lin and Capacitor Cin to simulate source impedance.

## APPLICATION NOTES

### 1. Recommended circuit

This series has been tested according to the following recommended testing circuit before leaving the factory. This series should be tested under load (see Figure 3). If you want to further decrease the input/output ripple, you can increase the capacitance accordingly or choose capacitors with low ESR (see Table 3). However, the capacitance of the output filter capacitor must be appropriate. If the capacitance is too high, a startup problem might arise. For every channel of the output, to ensure safe and reliable operation, the maximum capacitance must be less than the maximum capacitive load (see Table 4).

Figure 3

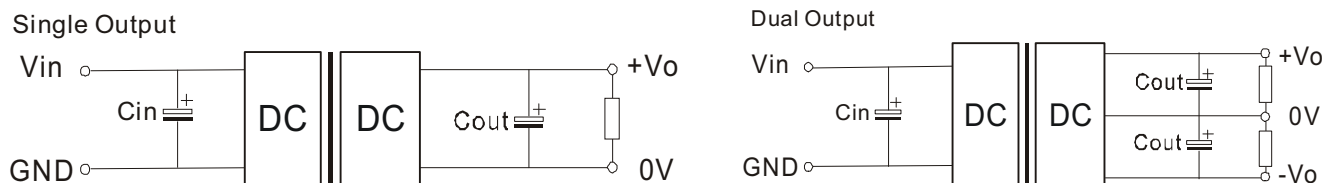

Table 3

Vin (Vdc)	Cin (μF)	Cout (μF)
24	100	10
48	10~47	10

Table 4

Single Vout (Vdc)	Max. Capacitive Load (μF)	Dual Vout (Vdc)	Max. Capacitive Load <sup>1</sup> (μF)
3.3	1800	--	--
5	1000	±5	470
12	100	±12	100
15	100	±15	100
24	47	--	--

Note: 1. For each output.

Note: 1. Minimum load shouldn't be less than 5%, otherwise ripple may increase dramatically. Operation under minimum load will not damage the converter, however, they may not meet all specifications listed.  
 2. Maximum capacitive load is tested at input voltage range and full load.  
 3. All specifications are measured at Ta=25°C, humidity<75%, nominal input voltage and rated output load unless otherwise specified.

## REVISION HISTORY

---

rev.	description	date
1.0	initial release	06/17/2013
1.01	added CE safety approval	10/29/2013

The revision history provided is for informational purposes only and is believed to be accurate.



**Headquarters**  
20050 SW 112th Ave.  
Tualatin, OR 97062  
**800.275.4899**

Fax 503.612.2383  
**cui.com**  
techsupport@cui.com

CUI offers a two (2) year limited warranty. Complete warranty information is listed on our website.

CUI reserves the right to make changes to the product at any time without notice. Information provided by CUI is believed to be accurate and reliable. However, no responsibility is assumed by CUI for its use, nor for any infringements of patents or other rights of third parties which may result from its use.

CUI products are not authorized or warranted for use as critical components in equipment that requires an extremely high level of reliability. A critical component is any component of a life support device or system whose failure to perform can be reasonably expected to cause the failure of the life support device or system, or to affect its safety or effectiveness.

# Mouser Electronics

Authorized Distributor

Click to View Pricing, Inventory, Delivery & Lifecycle Information:

## CUI Inc.:

[PQD6-Q48-S5-D](#) [PQD6-Q48-S3-D](#) [PQD6-Q24-S3-D](#) [PQD6-Q24-S5-D](#) [PQD6-Q24-D12-D](#) [PQD6-Q48-D15-D](#)  
[PQD6-Q24-D15-D](#) [PQD6-Q48-S12-D](#) [PQD6-Q48-D12-D](#) [PQD6-Q24-D5-D](#) [PQD6-Q24-S15-D](#) [PQD6-Q24-S24-D](#)  
[PQD6-Q48-S15-D](#) [PQD6-Q48-S24-D](#) [PQD6-Q48-D5-D](#) [PQD6-Q24-S12-D](#)