

IEC Plug I, Cord Connector (Rewireable), Angled



4789 - IEC connector 1 for cable mounting
 angled
 black



Example with assembled cable angled



See below:

Approvals and Compliances

Description

- Rewireable plug for cable 90° entry :
 Screwing cable terminal
- 1 Function
- Appliance Inlet , Pin temperature 70 °C , Protection class I
- Screw clamps

Characteristics

- Suitable for use in equipment according to IEC/UL 60950

References

Substitute for type [1611](#)

Weblinks

[pdf data sheet](#), [html datasheet](#), [General Product Information](#), [Distributor-Stock-Check](#), [Accessories](#), [Detailed request for product](#)

Technical Data

Ratings IEC	16A / 250VAC; 50Hz	appliance inlet/-outlet	I acc. to IEC 60320-1, UL 60320-1, CSA C22.2 no. 60320-1 (for cold conditions) pin-temperature 70 °C, 16A, Protection Class I
Ratings UL/CSA	20A / 250VAC; 60Hz		
Dielectric Strength	> 2 kVAC between L-N > 2 kVAC between L/N-PE (1 min/50Hz)		
Allowable Operation Temperature	-25 °C to 70 °C		
Protection against electric shock	Suitable for appliances with protection class I acc. to IEC 61140		
Terminal	Screw		
Material: Housing	Thermoplastic, black, UL 94V-0		

Approvals and Compliances

Detailed information on product approvals, code requirements, usage instructions and detailed test conditions can be looked up in [Details about Approvals](#)

SCHURTER products are designed for use in industrial environments. They have approvals from independent testing bodies according to national and international standards. Products with specific characteristics and requirements such as required in the automotive sector according to IATF 16949, medical technology according to ISO 13485 or in the aerospace industry can be offered exclusively with customer-specific, individual agreements by SCHURTER.

Approvals



The approval mark is used by the testing authorities to certify compliance with the safety requirements placed on electronic products.

Approval Reference Type: 4789

Approval Logo	Certificates	Certification Body	Description
	VDE Approvals	VDE	Certificate Number: 40008629
	UL Approvals	UL	UL File Number: E96454
	CCC Approvals	CCC	CCC Certificate Number: 2014010204709155

Product standards

Product standards that are referenced

Organization	Design	Standard	Description
	Designed according to	IEC 60320-1	Appliance couplers for household and similar general purposes
	Designed according to	UL 60320-1	Standard for Attachment Plugs and Receptacles
	Designed according to	CSA C22.2 no. 60320-1	General Use Receptacles, Attachment Plugs, and Similar Wiring Devices





Application standards

Application standards where the product can be used

Organization	Design	Standard	Description
	Designed for applications acc.	IEC/UL 60950	IEC 60950-1 includes the basic requirements for the safety of information technology equipment.

Compliances

The product complies with following Guide Lines

Identification	Details	Initiator	Description
	CE declaration of conformity	SCHURTER AG	The CE marking declares that the product complies with the applicable requirements laid down in the harmonisation of Community legislation on its affixing in accordance with EU Regulation 765/2008.
	RoHS	SCHURTER AG	Directive RoHS 2011/65/EU, Amendment (EU) 2015/863
	China RoHS	SCHURTER AG	The law SJ / T 11363-2006 (China RoHS) has been in force since 1 March 2007. It is similar to the EU directive RoHS.
	REACH	SCHURTER AG	On 1 June 2007, Regulation (EC) No 1907/2006 on the Registration, Evaluation, Authorization and Restriction of Chemicals 1 (abbreviated as "REACH") entered into force.

Dimensions [mm]

4789

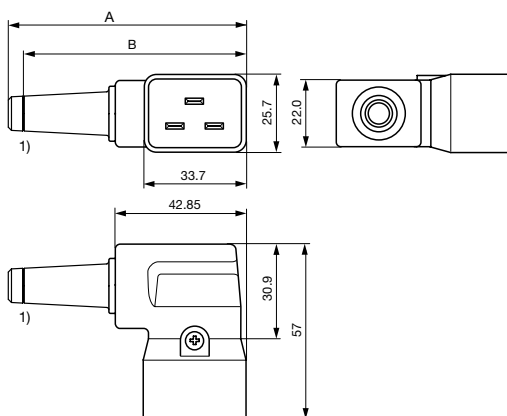

1) Cut strain relief 8 (10) mm here for 10 mm cable

A: Strain relief 8 mm: 77.85 mm

B: Strain relief 10 mm: 72.85 mm

All Variants

Color	Recommended cable diameter	Max. wire size	L = Length of cable guard	Order Number
black	8 (10) mm	3 x 1.5 mm ² / 3 x 14 AWG	-	4789.1100
black	10 mm	3 x 1.5 mm ² / 3 x 14 AWG	-	4789.1200

 Most Popular.

Availability for all products can be searched real-time: <https://www.schurter.com/en/Stock-Check/Stock-Check-SCHURTER>

Max. torque for screws: Terminals: 0.8 Nm, Cable clamps: 0.8 Nm, Cover: 0.5 Nm

Packaging unit 50 Pcs

Mating Outlets/Connectors

Category / Description



[Appliance Outlet Overview complete](#)

4797-5, Mounting: Snap-in version, For PCB mounting, 250 VAC, 16 A, Appliance Outlet: IEC type J	4797-5
4797, Mounting: Snap-in or screw-on mounting, Solder terminals or quick connect terminals, 250 VAC, 16 A, Appliance Outlet: IEC type J	4797
5017, Mounting: Screw-on mounting, 250 VAC, 16 A, Appliance Outlet: IEC	5017
5216, Mounting: Screw-on mounting, Quick connect terminals, 250 VAC, 16 A, Appliance Outlet: IEC type J	5216

[Appliance Outlet further types to 4789](#)



[Connector Overview complete](#)

4795, Mounting: Power Cord, Cable Connector: IEC C19	4795
4790, Mounting: Power Cord, Screw Connector: IEC C19	4790
0104U, Mounting: Power Supply Cord, Screw clamps Connector: IEC C19	0104U

[Connector further types to 4789](#)

Mouser Electronics

Authorized Distributor

Click to View Pricing, Inventory, Delivery & Lifecycle Information:

[Schurter:](#)

[4789.1100](#) [4789.1200](#)