

Sensor/actuator cable - SAC-8P-M 8MS/ 0,3-PUR/M 8FR - 1404201

Please be informed that the data shown in this PDF Document is generated from our Online Catalog. Please find the complete data in the user's documentation. Our General Terms of Use for Downloads are valid (<http://phoenixcontact.com/download>)



Sensor/actuator cable, 8-position, PUR halogen-free, black-gray RAL 7021, Plug straight M8, on Socket angled M8, cable length: 0.3 m

Your advantages

- ✓ Easy and safe: 100% electrically tested plug-in components
- ✓ Our standard: robust halogen-free PUR cable
- ✓ Save space – with high-pos. connectors

RoHS

Key Commercial Data

Packing unit	1 pc
GTIN	 4 046356 681216
GTIN	4046356681216

Technical data

Dimensions

Length of cable	0.3 m
-----------------	-------

Ambient conditions

Ambient temperature (operation)	-25 °C ... 85 °C (Plug / socket)
Degree of protection	IP65
	IP67
	IP68

General

Rated current at 40°C	1.5 A
Rated voltage	30 V AC
	30 V DC
Number of positions	8
Insulation resistance	≥ 100 MΩ

Sensor/actuator cable - SAC-8P-M 8MS/ 0,3-PUR/M 8FR - 1404201

Technical data

General

Coding	A - standard
Standards/regulations	M8 connector IEC 61076-2-104
Status display	No
Protective circuit/component	unwired
Degree of pollution	3
Insertion/withdrawal cycles	≥ 100
Torque	0.2 Nm (M8 connectors)

Material

Flammability rating according to UL 94	HB
Contact material	CuSn
Contact surface material	Ni/Au
Contact carrier material	TPU GF
Material of grip body	TPU, hardly inflammable, self-extinguishing
Material, knurls	Zinc die-cast, nickel-plated

Standards and Regulations

Standards/specifications	M8 connector IEC 61076-2-104
Flammability rating according to UL 94	HB

Cable

Cable abbreviation	Li9Y11Y
UL AWM style	20549
Conductor cross section	8x 0.14 mm ² (Signal line)
AWG signal line	26
Conductor structure signal line	18x 0.10 mm
Core diameter including insulation	1 mm ±0.02 mm (Signal line)
Thickness, insulation	≥ 0.21 mm (Signal line)
	≥ 0.38 mm (Outer cable sheath)
Wire colors	white, brown, green, yellow, gray, pink, blue, red
Overall twist	8 wires around filler to the core
Length of twist, overall twist	58 mm
External sheath, color	black-gray RAL 7021
External cable diameter D	5.1 mm ±0.15 mm
Smallest bending radius, fixed installation	25.5 mm
Smallest bending radius, movable installation	51 mm
Number of bending cycles	4000000
Bending radius	51 mm
Traversing path	10 m
Traversing rate	3 m/s
Acceleration	10 m/s ²
Outer sheath, material	PUR

Sensor/actuator cable - SAC-8P-M 8MS/ 0,3-PUR/M 8FR - 1404201

Technical data

Cable

Material, filler	PE
Material conductor insulation	PP
Conductor material	Bare Cu litz wires
Insulation resistance	1 GΩ*km (at 20 °C)
Conductor resistance	139 Ω/km (at 20 °C)
Nominal voltage, cable	≤ 300 V AC
Test voltage, cable	≥ 3000 V AC (Spark test)
Flame resistance	according to UL 758/1581 (horizontal)
	in accordance with UL 758/1581 FT2
Halogen-free	in accordance with DIN VDE 0472 part 815
	in accordance with DIN EN 50267-2-1
Resistance to oil	According to DIN EN 60811-2-1, 168 h at 100°C
Other resistance	hydrolysis and microbe resistant
	Resistant to salt water
	Low adhesion
	abrasion-resistant
	partly UV-resistant in accordance with DIN EN ISO 4892-2-A
Ambient temperature (operation)	-40 °C ... 80 °C (cable, fixed installation)
	-25 °C ... 80 °C (cable, flexible installation)

Environmental Product Compliance

	Lead 7439-92-1
China RoHS	Environmentally Friendly Use Period = 50
	For details about hazardous substances go to tab "Downloads", Category "Manufacturer's declaration"

Drawings

Sensor/actuator cable - SAC-8P-M 8MS/ 0,3-PUR/M 8FR - 1404201

Schematic diagram

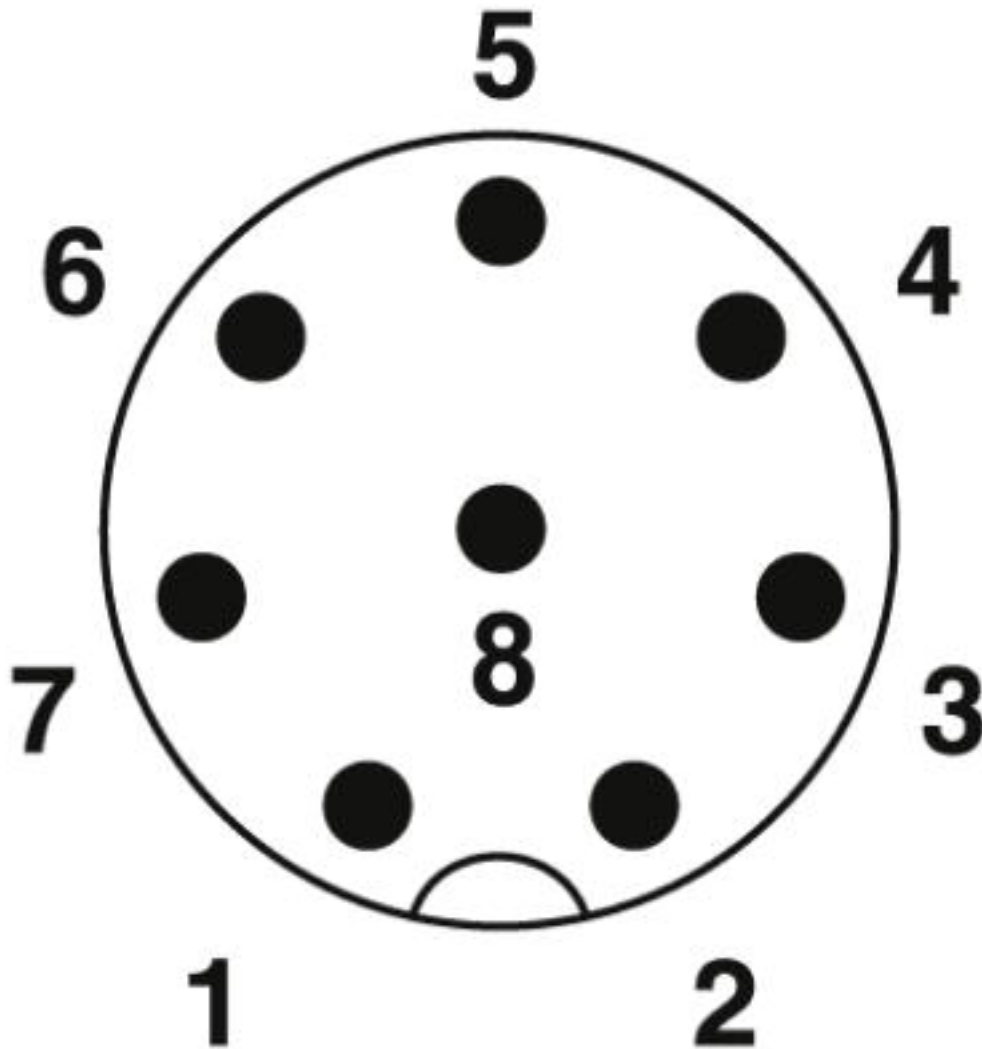

M8 plug pin assignment, 8-pos., view of pin side

Sensor/actuator cable - SAC-8P-M 8MS/ 0,3-PUR/M 8FR - 1404201

Schematic diagram

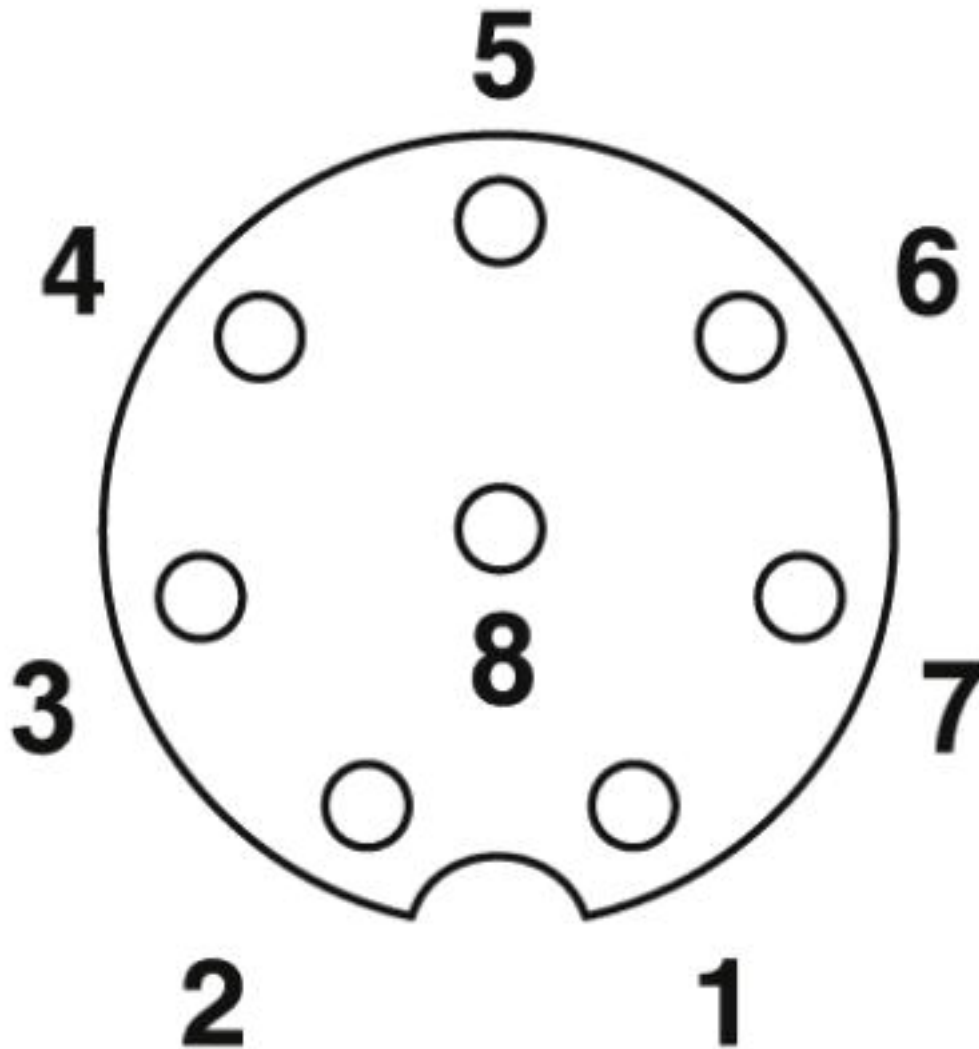

Connector pin assignment of M8 socket, 8-pos., view of socket side

Sensor/actuator cable - SAC-8P-M 8MS/ 0,3-PUR/M 8FR - 1404201

Dimensional drawing

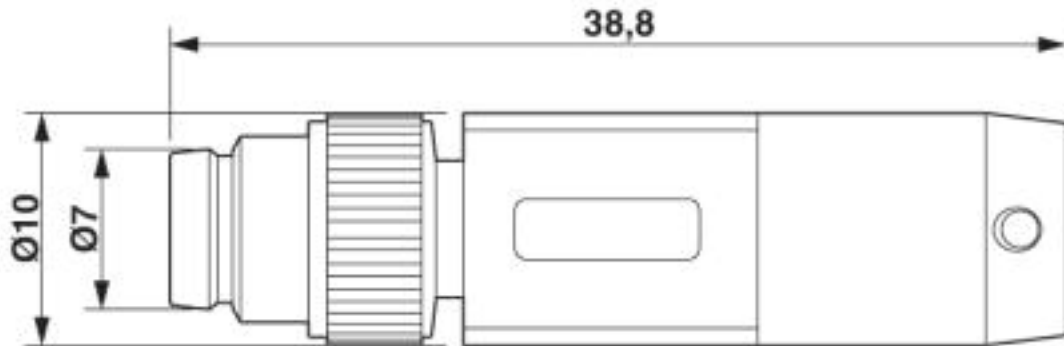

M8 x 1 male plug, straight version

Dimensional drawing

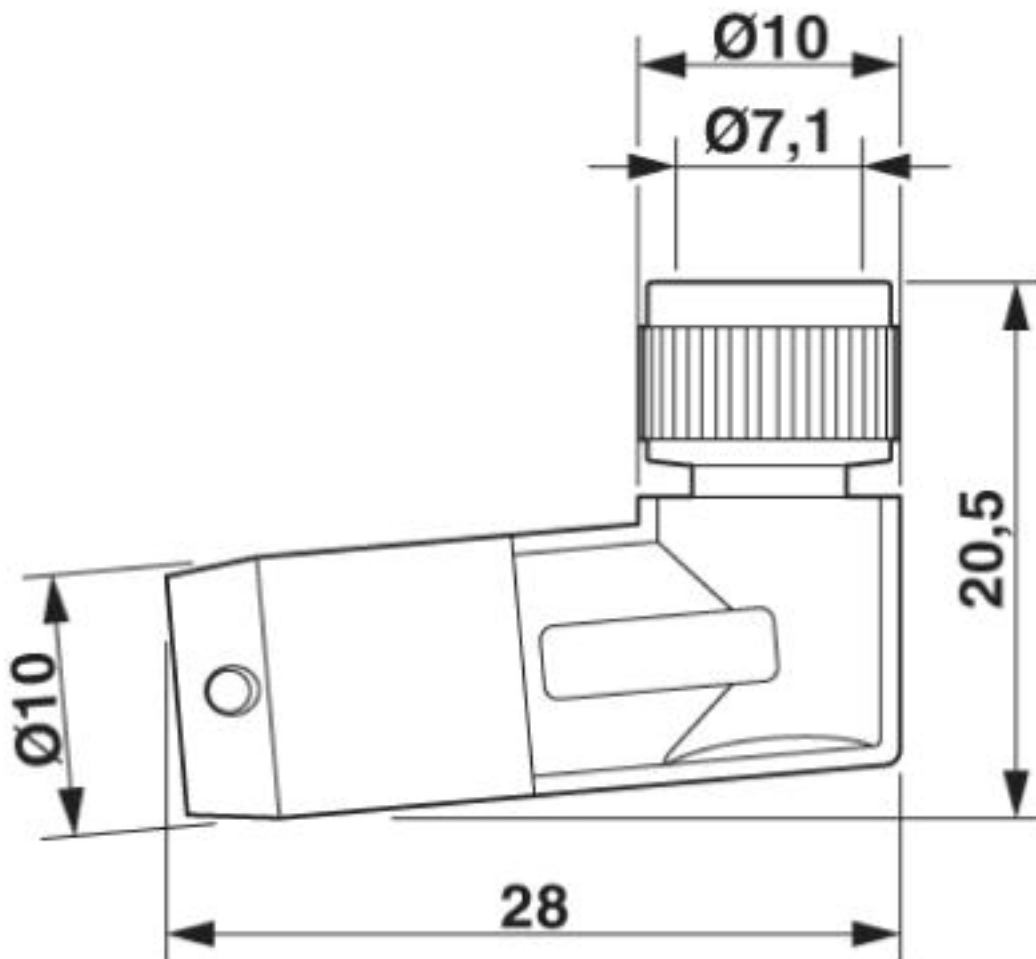

Socket M8 x 1, angled

Sensor/actuator cable - SAC-8P-M 8MS/ 0,3-PUR/M 8FR - 1404201

Circuit diagram

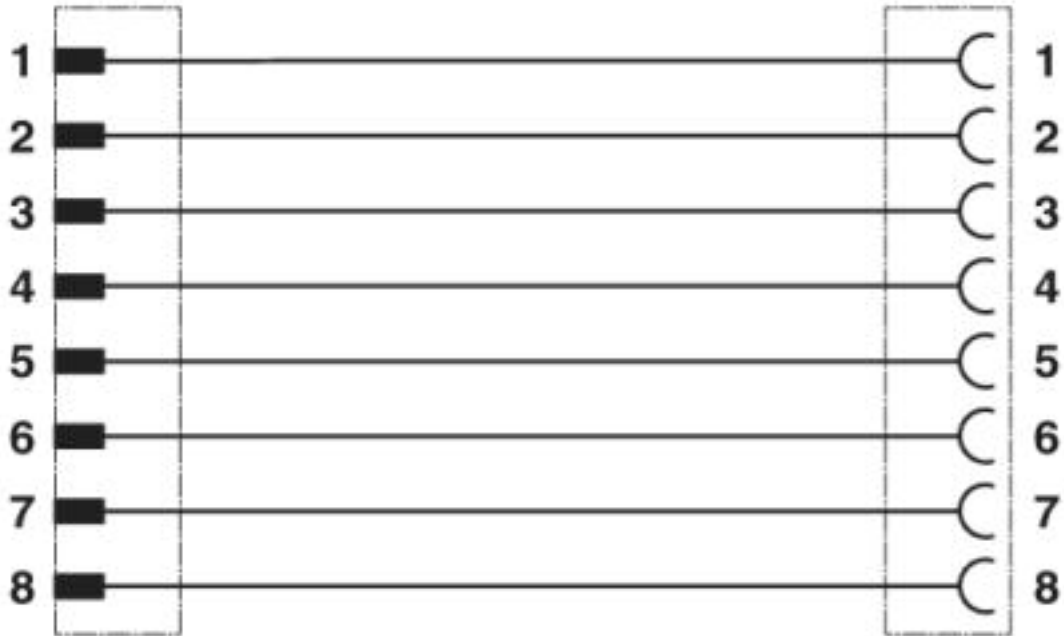

Contact assignment of M8 plugs/sockets

Sensor/actuator cable - SAC-8P-M 8MS/ 0,3-PUR/M 8FR - 1404201

Cable cross section



PUR halogen-free black [PUR]

Classifications

eCl@ss

eCl@ss 4.0	27060300
eCl@ss 4.1	27060300
eCl@ss 5.0	27061800
eCl@ss 5.1	27061800
eCl@ss 6.0	27279200
eCl@ss 7.0	27279218
eCl@ss 8.0	27279218
eCl@ss 9.0	27060311

Sensor/actuator cable - SAC-8P-M 8MS/ 0,3-PUR/M 8FR - 1404201

Classifications

ETIM

ETIM 3.0	EC001855
ETIM 4.0	EC001855
ETIM 5.0	EC001855
ETIM 6.0	EC001855
ETIM 7.0	EC001855

UNSPSC

UNSPSC 6.01	31251501
UNSPSC 7.0901	31251501
UNSPSC 11	31251501
UNSPSC 12.01	31251501
UNSPSC 13.2	31251501
UNSPSC 19.0	31251501
UNSPSC 20.0	31251501
UNSPSC 21.0	31251501

Approvals

Approvals

Approvals

UL Listed / cUL Listed / EAC / cULus Listed

Ex Approvals

Approval details

UL Listed		http://database.ul.com/cgi-bin/XYV/template/LISEXT/1FRAME/index.htm	FILE E 221474
Nominal voltage UN	30 V		
Nominal current IN	1.5 A		

cUL Listed		http://database.ul.com/cgi-bin/XYV/template/LISEXT/1FRAME/index.htm	FILE E 221474
Nominal voltage UN	30 V		
Nominal current IN	1.5 A		

Sensor/actuator cable - SAC-8P-M 8MS/ 0,3-PUR/M 8FR - 1404201

Approvals

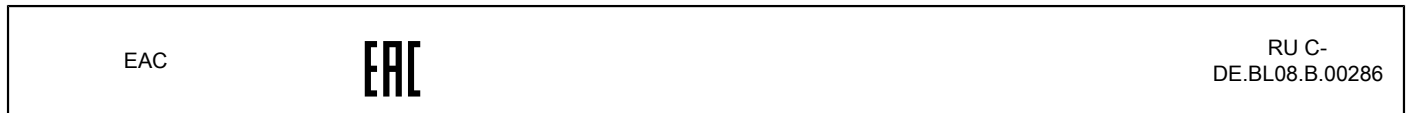

Accessories

Accessories

Conductor marking

Insert label - PABA WH/23 - 1013779



Insert label, Strip, white, unlabeled, can be labeled with: CMS-P1-PLOTTER, mounting type: thread on, cable diameter range: 1.5 ... 35 mm, lettering field size: 23 x 4 mm, Number of individual labels: 20

Insert label - PABA YE/23 - 1013782



Insert label, Strip, yellow, unlabeled, can be labeled with: CMS-P1-PLOTTER, mounting type: thread on, cable diameter range: 1.5 ... 35 mm, lettering field size: 23 x 4 mm, Number of individual labels: 20

Marker pen

Marker pen - B-STIFT - 1051993



Marker pen, for manual labeling of unprinted Zack strips, smear-proof and waterproof, line thickness 0.5 mm

Plug for cable screw gland

Sensor/actuator cable - SAC-8P-M 8MS/ 0,3-PUR/M 8FR - 1404201

Accessories

Screw plug - PROT-M 8 MS-PA-CHAIN - 1430860

M8 sealing cap made of plastic with fixing band for sensor cables, for M8 sockets



Protective cap

Sealing cap - PROT-M 8 FS-PA-CHAIN - 1430857

M8 sealing cap made of plastic with fixing band for sensor cables, for M8 plugs



Screwdriver tools

Tool - SAC BIT M8-D10 - 1208461



Nut for assembling M8 connectors with longitudinal knurl and a knurl diameter of 10 mm, for 4 mm hexagonal drive

Torque tool

Torque screwdriver - TSD 02 SAC - 1208487



Torque screwdriver, with preset torque of 0.2 Nm and 4 mm hexagonal drive for M8 connectors