

CERAMIC WIRE WOUND INDUCTORS

AISC-0603

RoHS/RoHS II Compliant



1.80 x 1.12 x 1.02mm

FEATURES:

- Ceramic construction assures the utmost thermal stability & high SRF
- Exceptionally high Q compared to non-wirewound inductors, especially at high frequencies
- Inductance options from 1.8nH to 560nH
- Epoxy coating protects wound wire

APPLICATIONS:

- Widely applied in VCO, SAW circuit for GSM, and CDMA communications

ELECTRICAL SPECIFICATIONS:

Part Number AISC-0603- Inductance Code	Inductance	Tolerance	Min. Quality Factor	L/Q Test Freq.	Max. DC Resistance	Max. Rated Current	Min. Self-resonant Frequency
Units	nH	-	-	MHz	Ω	mA	MHz
Symbol	L	-	Q	Freq.	DCR	Ir	S.R.F
AISC-0603-R0018	1.8	C, S, D J, K	18	250	0.043	1000	> 6000
AISC-0603-R0027	2.7	C, S, D J, K	25	250	0.043	1000	> 6000
AISC-0603-R0033	3.3	C, S, D J, K	25	250	0.059	850	> 6000
AISC-0603-R0036	3.6	C, S, D J, K	25	250	0.059	850	> 6000
AISC-0603-R0039	3.9	C, S, D J, K	25	250	0.059	850	> 6000
AISC-0603-R0043	4.3	C, S, D J, K	25	250	0.059	850	> 6000
AISC-0603-R0047	4.7	C, S, D J, K	25	250	0.065	800	> 6000
AISC-0603-R0051	5.1	C, S, D J, K	21	250	0.130	600	> 6000
AISC-0603-R0062	6.2	C, S, D J, K	29	250	0.095	700	> 6000
AISC-0603-R0068	6.8	C, S, D, G, J, K	29	250	0.095	700	> 6000
AISC-0603-R0075	7.5	C, S, D, G, J, K	33	250	0.095	700	> 6000
AISC-0603-R0082	8.2	C, S, D, G, J, K	31	250	0.095	700	> 6000
AISC-0603-R0087	8.7	C, S, D, G, J, K	31	250	0.095	700	> 6000
AISC-0603-R0091	9.1	C, S, D, G, J, K	30	250	0.120	620	6000
AISC-0603-R0095	9.5	C, S, D, G, J, K	26	250	0.160	540	6000
AISC-0603-R010	10	C, S, D, G, J, K	30	250	0.130	600	6000
AISC-0603-R011	11	C, S, D, G, J, K	35	250	0.130	600	6000
AISC-0603-R012	12	C, S, D, G, J, K	35	250	0.130	600	6000
AISC-0603-R013	13	C, S, D, G, J, K	35	250	0.130	600	6000
AISC-0603-R015	15	C, S, D, G, J, K	37	250	0.150	550	6000
AISC-0603-R016	16	C, S, D, G, J, K	37	250	0.150	550	5500
AISC-0603-R018	18	C, S, D, G, J, K	37	250	0.150	550	5500
AISC-0603-R020	20	C, S, D, G, J, K	37	250	0.150	550	4900
AISC-0603-R022	22	C, S, D, G, J, K	38	250	0.190	490	4600
AISC-0603-R023	23	C, S, D, G, J, K	40	250	0.190	490	3800
AISC-0603-R024	24	C, S, D, G, J, K	40	250	0.190	490	3800
AISC-0603-R025	25	C, S, D, G, J, K	40	250	0.190	490	3700
AISC-0603-R027	27	C, S, D, G, J, K	38	250	0.190	490	3700
AISC-0603-R030	30	C, S, D, G, J, K	38	250	0.210	470	3300
AISC-0603-R033	33	C, S, D, G, J, K	40	250	0.210	470	3200
AISC-0603-R036	36	C, S, D, G, J, K	40	250	0.220	460	2900
AISC-0603-R039	39	C, S, D, G, J, K	40	250	0.220	460	2800
AISC-0603-R043	43	C, S, D, G, J, K	40	250	0.270	400	2700
AISC-0603-R047	47	C, S, D, G, J, K	36	200	0.270	400	2600
AISC-0603-R051	51	C, S, D, G, J, K	35	200	0.300	390	2400
AISC-0603-R056	56	C, S, D, G, J, K	38	200	0.350	360	2400
AISC-0603-R062	62	C, S, D, G, J, K	36	200	0.380	350	2300



CERAMIC WIRE WOUND INDUCTORS

AISC-0603

RoHS/RoHS II Compliant



1.80 x 1.12 x 1.02mm

ELECTRICAL SPECIFICATIONS (cont'd):

Part Number AISC-0603- Inductance Code	Inductance	Tolerance	Min. Quality Factor	L/Q Test Freq.	Max. DC Resistance	Max. Rated Current	Min. Self-resonant Frequency
Units	nH	-	-	MHz	Ω	mA	MHz
Symbol	L	-	Q	Freq.	DCR	Ir	S.R.F
AISC-0603-R068	68	C, S, D, G, J, K	36	200	0.380	350	2200
AISC-0603-R072	72	C, S, D, G, J, K	34	150	0.430	320	2100
AISC-0603-R082	82	C, S, D, G, J, K	34	150	0.500	300	2000
AISC-0603-R091	91	C, S, D, G, J, K	34	150	0.520	300	1900
AISC-0603-R10	100	C, S, D, G, J, K	31	150	0.660	260	1800
AISC-0603-R11	110	C, S, D, G, J, K	32	150	0.730	250	1700
AISC-0603-R12	120	C, S, D, G, J, K	32	150	0.750	240	1600
AISC-0603-R15	150	C, S, D, G, J, K	32	150	1.120	200	1400
AISC-0603-R16	160	C, S, D, G, J, K	32	150	1.120	200	1400
AISC-0603-R18	180	C, S, D, G, J, K	25	100	1.380	180	1300
AISC-0603-R20	200	C, S, D, G, J, K	25	100	1.900	150	1250
AISC-0603-R22	220	C, S, D, G, J, K	25	100	2.100	140	1200
AISC-0603-R25	250	C, S, D, G, J, K	25	100	2.800	120	1100
AISC-0603-R27	270	C, S, D, G, J, K	26	100	3.000	120	960
AISC-0603-R33	330	C, S, D, G, J, K	26	100	4.200	100	800
AISC-0603-R39	390	C, S, D, G, J, K	27	100	4.500	100	800
AISC-0603-R42	420	C, S, D, G, J, K	27	100	5.400	90	800
AISC-0603-R47	470	C, S, D, G, J, K	27	100	5.700	90	700
AISC-0603-R56	560	C, S, D, G, J, K	27	100	8.100	70	650

Definition of Rated Current (Ir): Ir is direct electric current as chip surface temperature rose just 20°C against chip initial surface temperature (Ta)

Operating Temperature: -40°C to +125°C

Storage Temperature: -10°C to +40°C, 70% RH max.

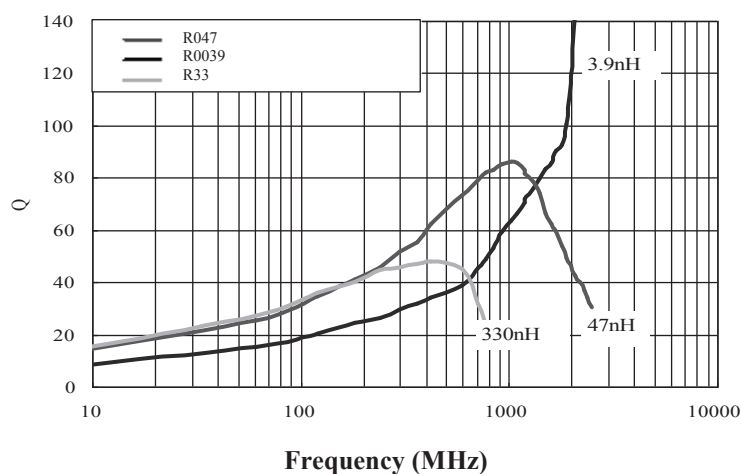
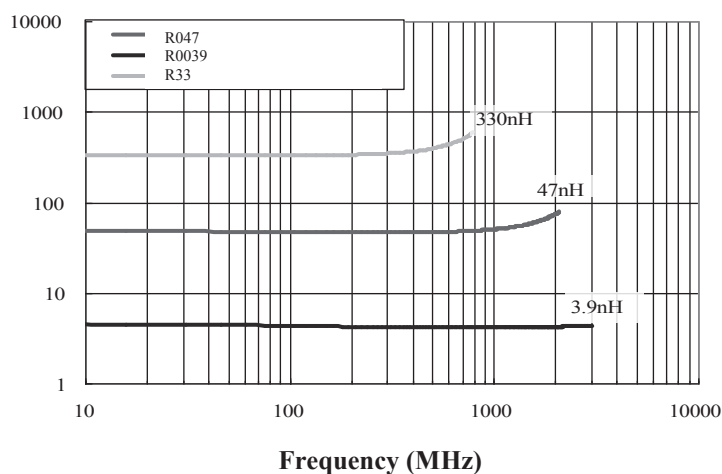

CERAMIC WIRE WOUND INDUCTORS

AISC-0603

RoHS/RoHS II Compliant



1.80 x 1.12 x 1.02mm

OPTIONS AND PART IDENTIFICATION:

AISC-0603- -

Inductance Code	Tolerance Code	Packaging
Please refer to the Table	C: $\pm 0.2\text{nH}$	T: 3kpcs/reel
	S: $\pm 0.3\text{nH}$	
	D: $\pm 0.5\text{nH}$	
	G: $\pm 2\%$	
	J: $\pm 5\%$	
	K: $\pm 10\%$	

MECHANICAL DIMENSIONS:

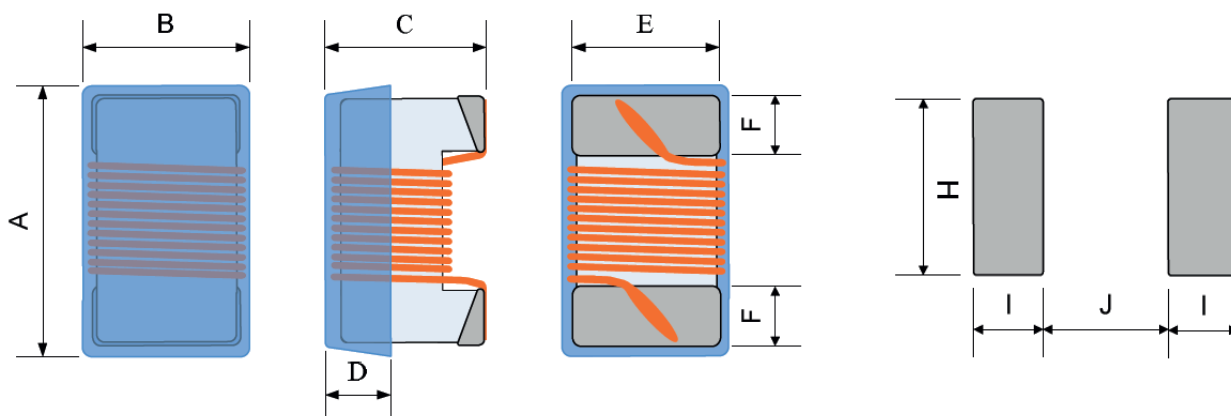

A MAX.	B MAX.	C MAX.	D REF.	E REF.	F REF.	H REF.	I REF.	J REF.
1.8	1.12	1.02	0.38	0.80	0.30	1.02	0.64	0.64

Dimension: mm

MATERIALS:

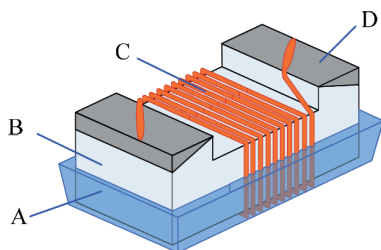

No.	Components	Material
A	Coating	Ultraviolet epoxy resin
B	Core	Ceramic
C	Wire	Polyurethane system enameled copper wire
D	Electrodes	Ag-Pd with Ni and Au plating

CERAMIC WIRE WOUND INDUCTORS

AISC-0603

RoHS/RoHS II Compliant



1.80 x 1.12 x 1.02mm

PACKING:

T= tape and reel (3,000pcs/reel)

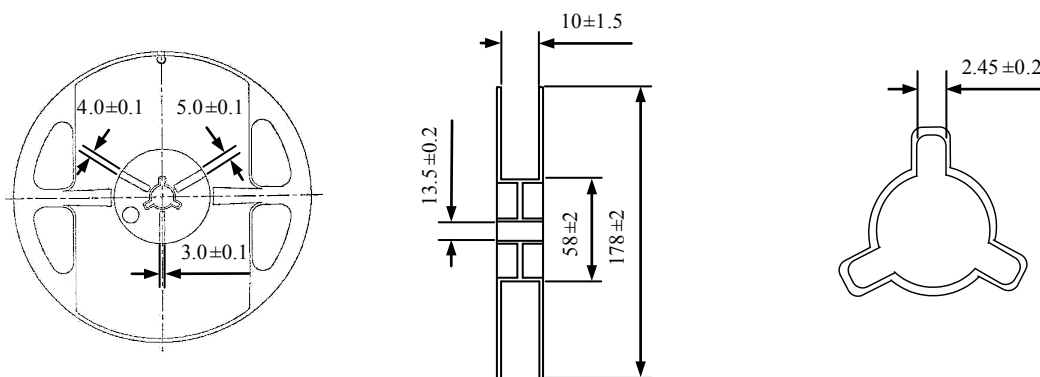
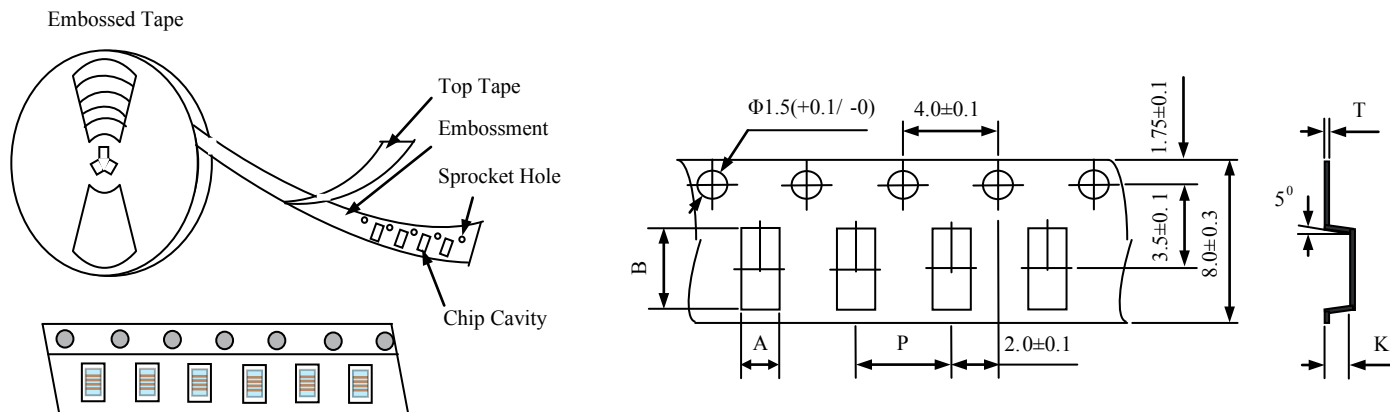

Dimension: mm

REFLOW PROFILE:

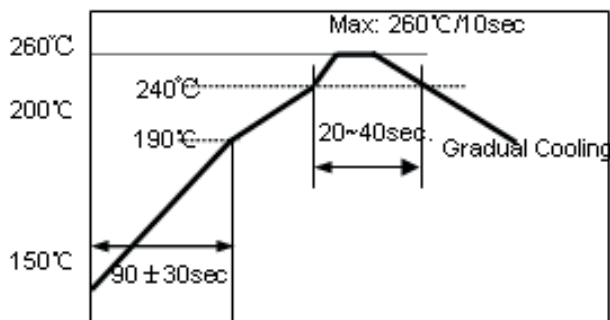

- 1~2 °C/sec. Ramp
- Pre-heating: 150~190°C/90±30 sec.
- Time above 240°C: 20~40sec
- Peak temperature: 260°C Max./10sec.
- Solder paste: Sn/3.0Ag/0.5Cu
- Max.2 times for re-flowing

ATTENTION Abracon Corporation's products are COTS – Commercial-Off-The-Shelf products; suitable for Commercial, Industrial and, where designated, Automotive Applications. Abracon's products are not specifically designed for Military, Aviation, Aerospace, Life-dependant Medical applications or any application requiring high reliability where component failure could result in loss of life and/or property. For applications requiring high reliability and/or presenting an extreme operating environment, written consent and authorization from Abracon Corporation is required. Please contact Abracon Corporation for more information.

ABRACON IS
ISO9001:2008
CERTIFIED



Visit www.abracon.com for Terms & Conditions of Sale **Revised: 09.16.13**
30332 Esperanza, Rancho Santa Margarita, California 92688
tel 949-546-8000 | fax 949-546-8001 | www.abracon.com

Mouser Electronics

Authorized Distributor

Click to View Pricing, Inventory, Delivery & Lifecycle Information:

ABRACON:

[AISC-0603-R0068G-T](#) [AISC-0603-R0075G-T](#) [AISC-0603-R0082G-T](#) [AISC-0603-R0087G-T](#) [AISC-0603-R0095G-T](#)
[AISC-0603-R010G-T](#) [AISC-0603-R011G-T](#) [AISC-0603-R012G-T](#) [AISC-0603-R015G-T](#) [AISC-0603-R018G-T](#) [AISC-](#)
[0603-R022G-T](#) [AISC-0603-R024G-T](#) [AISC-0603-R027G-T](#) [AISC-0603-R033G-T](#) [AISC-0603-R037G-T](#) [AISC-0603-](#)
[R039G-T](#) [AISC-0603-R047G-T](#) [AISC-0603-R051G-T](#) [AISC-0603-R056G-T](#) [AISC-0603-R068G-T](#) [AISC-0603-R072G-](#)
[T](#) [AISC-0603-R082G-T](#) [AISC-0603-R10G-T](#) [AISC-0603-R11G-T](#) [AISC-0603-R12G-T](#) [AISC-0603-R15G-T](#) [AISC-](#)
[0603-R18G-T](#) [AISC-0603-R22G-T](#) [AISC-0603-R27G-T](#) [AISC-0603-R33G-T](#) [AISC-0603-R39G-T](#) [AISC-0603-R010J-T](#)
[AISC-0603-R0062J-T](#) [AISC-0603-R0075J-T](#) [AISC-0603-R0056J-T](#) [AISC-0603-R012J-T](#) [AISC-0603-R015J-T](#) [AISC-](#)
[0603-R0068J-T](#) [AISC-0603-R011J-T](#) [AISC-0603-R0095J-T](#) [AISC-0603-R0051J-T](#) [AISC-0603-R0047J-T](#) [AISC-0603-](#)
[R0087J-T](#) [AISC-0603-R0018J-T](#) [AISC-0603-R0082J-T](#) [AISC-0603-R0039J-T](#) [AISC-0603-R0043J-T](#) [AISC-0603-](#)
[R0033J-T](#) [AISC-0603-R047J-T](#) [AISC-0603-R018J-T](#) [AISC-0603-R033J-T](#) [AISC-0603-R024J-T](#) [AISC-0603-R068J-T](#)
[AISC-0603-R022J-T](#) [AISC-0603-R12J-T](#) [AISC-0603-R039J-T](#) [AISC-0603-R33J-T](#) [AISC-0603-R11J-T](#) [AISC-0603-](#)
[R27J-T](#) [AISC-0603-R22J-T](#) [AISC-0603-R027J-T](#) [AISC-0603-R051J-T](#) [AISC-0603-R39J-T](#) [AISC-0603-R056J-T](#)
[AISC-0603-R10J-T](#) [AISC-0603-R072J-T](#) [AISC-0603-R18J-T](#) [AISC-0603-R037J-T](#) [AISC-0603-R15J-T](#) [AISC-0603-](#)
[R082J-T](#)