



# 60×60×15 mm

San Ace 60 9P type

## General Specifications

- Material ..... Frame: Plastic (Flammability: UL 94V-0), Impeller: Plastic (Flammability: UL 94V-1)
- Expected life ..... See the table below. (L10 life: 90% survival rate for continuous operation in free air at 60°C, rated voltage)
- Motor protection function ..... Locked rotor burnout protection, Reverse polarity protection  
For details, please refer to p. 547.
- Dielectric strength ..... 50/60 Hz, 500 VAC, for 1 minute (between lead wire conductors and frame)
- Insulation resistance ..... 10 MΩ or more with a 500 VDC megger (between lead wire conductors and frame)
- Sound pressure level (SPL) ..... At 1 m away from the air inlet
- Storage temperature ..... -30 to +70°C (Non-condensing)
- Lead wire ..... ⊕Red ⊖Black or Blue (Sensor) Yellow
- Mass ..... 60 g

## Specifications

The models listed below **have ribs and pulse sensors.**

Model no.	Rated voltage [V]	Operating voltage range [V]	Rated current [A]	Rated input [W]	Rated speed [min <sup>-1</sup> ]	Max. airflow [m <sup>3</sup> /min] [CFM]	Max. static pressure [Pa] [inchH <sub>2</sub> O]	SPL [dB (A)]	Operating temperature [°C]	Expected life [h]		
<b>109P0605H701</b>	5	4.5 to 5.5	0.26	1.3	4100	0.4 14.1	38.2 0.153	32	-20 to +70	60000/60°C		
<b>109P0605M701</b>			0.15	0.75	3100	0.3 10.6	22.6 0.091	25				
<b>109P0612K701</b>	12	10.2 to 13.8	0.26	3.12	6500	0.62 21.9	99.3 0.399	45	-20 to +60	40000/60°C		
<b>109P0612S701</b>			0.15	1.8	5000	0.48 17.0	58.8 0.236	36				
<b>109P0612H701</b>		7 to 13.8	0.09	1.08	4100	0.4 14.1	38.2 0.153	32			-20 to +70	60000/60°C
<b>109P0612M701</b>			0.07	0.84	3100	0.3 10.6	22.6 0.091	25				
<b>109P0612B701</b>		10.2 to 13.8	0.05	0.6	2200	0.21 7.42	11.7 0.047	21			-20 to +70	60000/60°C
<b>109P0624J701</b>			0.14	3.36	6200	0.61 21.5	86.5 0.347	44				
<b>109P0624S701</b>	24	14 to 27.6	0.08	1.92	5000	0.48 16.9	58.8 0.236	36	-20 to +60	40000/60°C		
<b>109P0624H701</b>			0.06	1.44	4100	0.4 14.1	38.2 0.153	32				
<b>109P0624M701</b>		20.4 to 27.6	0.04	0.96	3100	0.3 10.6	22.6 0.091	25			-20 to +70	60000/60°C

The following sensor and control options are available for selection.

Available for all models. **Without sensor** **Lock sensor**

## Airflow - Static Pressure Characteristics

**109P0605H701** With pulse sensor

Operating voltage range

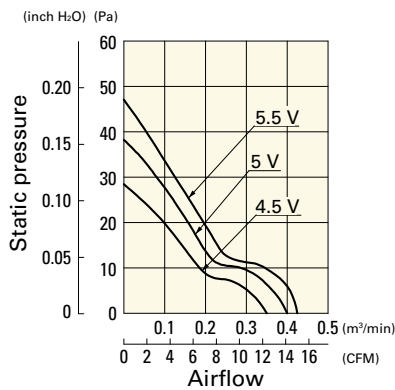

**109P0605M701** With pulse sensor

Operating voltage range

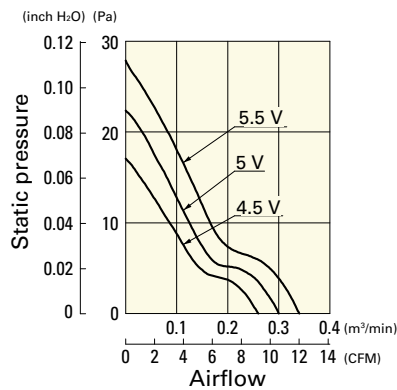

**109P0612K701** With pulse sensor

Operating voltage range

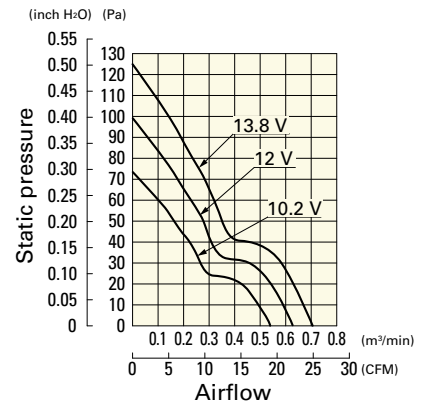

# Airflow - Static Pressure Characteristics

**109P0612S701** With pulse sensor

Operating voltage range

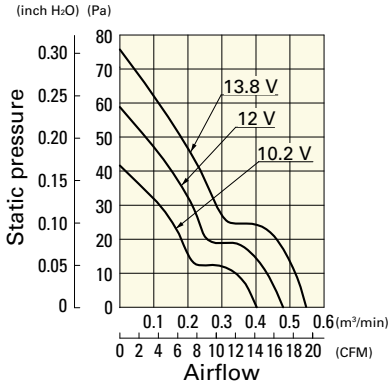

**109P0612H701** With pulse sensor

Operating voltage range

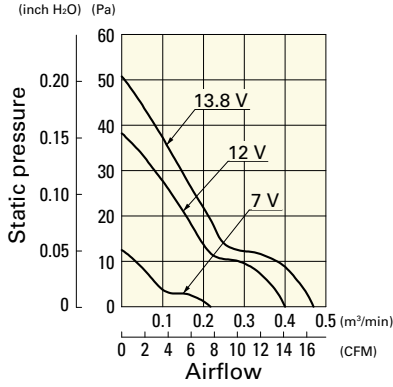

**109P0612M701** With pulse sensor

Operating voltage range

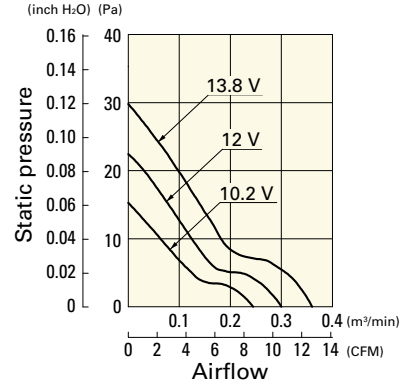

**109P0612B701** With pulse sensor

Operating voltage range

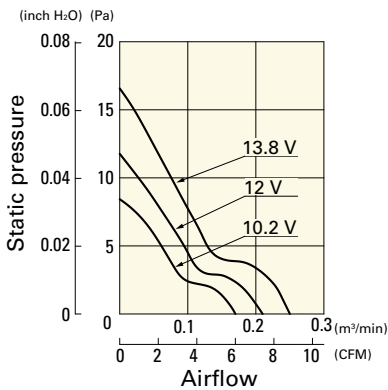

**109P0624J701** With pulse sensor

Operating voltage range

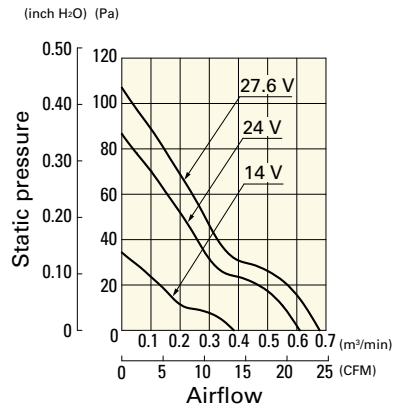

**109P0624S701** With pulse sensor

Operating voltage range

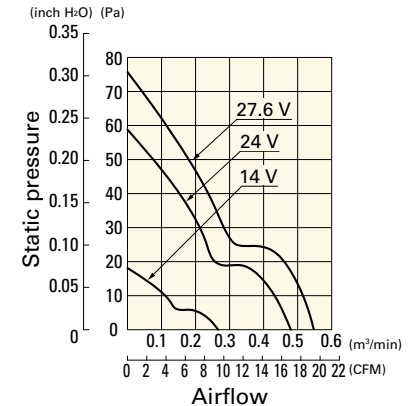

**109P0624H701** With pulse sensor

Operating voltage range

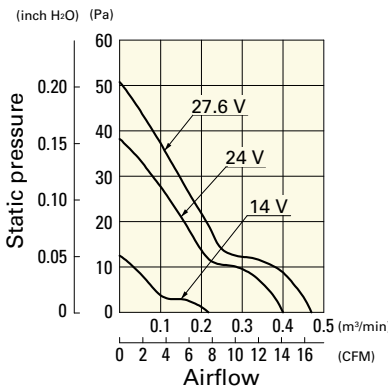

**109P0624M701** With pulse sensor

Operating voltage range

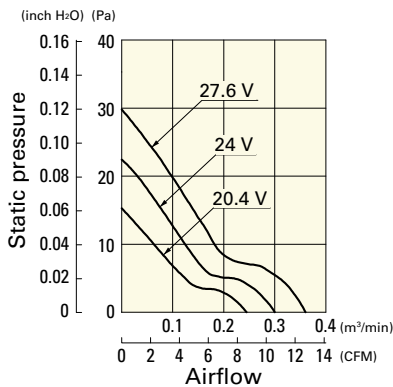

## ■ Dimensions (unit: mm)

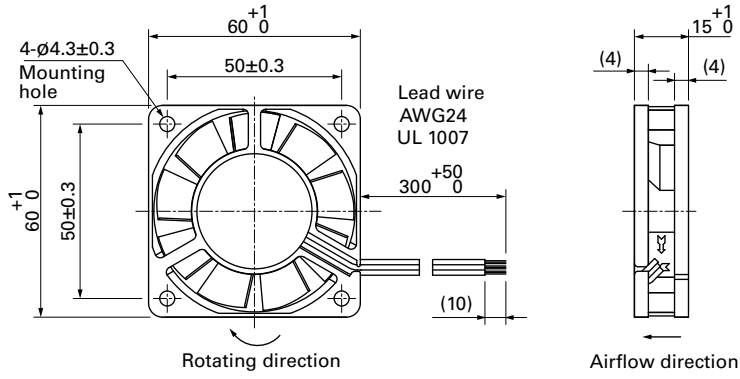

## ■ Reference Dimensions of Mounting Holes and Vent Opening (unit: mm)

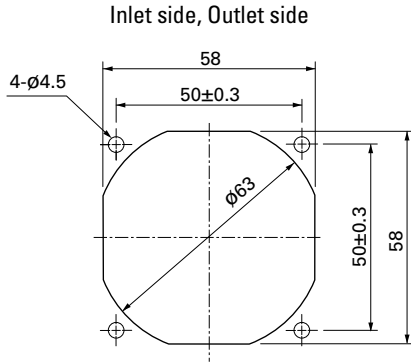

## ■ Options

### Finger guards

page: p. 532

Model no.: 109-139E, 109-139H

### Resin finger guards

page: p. 539

Model no.: 109-1003G

### Resin filter kits

page: p. 540

Model no.: 109-1003F13 (13PPI), 109-1003F20 (20PPI),  
109-1003F30 (30PPI), 109-1003F40 (40PPI)

# Mouser Electronics

Authorized Distributor

Click to View Pricing, Inventory, Delivery & Lifecycle Information:

## Sanyo Denki:

[109P0605H701](#) [109P0605H702](#) [109P0612K701](#) [109P0612S701](#) [109P0624H701](#) [109P0624H702](#) [109P0605M701](#)  
[109P0624M702](#) [109P0612M701](#) [109P0624M701](#) [109P0612S702](#) [109P0612H701](#) [109P0612B701](#) [109P0624J701](#)  
[109P0624S701](#) [109P0624S702](#) [109P0624S7D01](#) [109P0612B702](#) [109P0612K702](#) [109P0612H702](#) [109P0612H7D01](#)  
[109P0624M7D01](#) [109P0612B7D01](#) [109P0612M7D01](#) [109P0624J7D01](#) [109P0612S7D01](#) [109P0605M702](#)  
[109P0624H7D01](#) [109P0612M702](#) [109P0624J702](#) [109P0612K7D01](#) [109P0605H7D01](#) [109P0605M7D01](#)  
[109P0612J701](#) [109P0624K7D01](#) [109P0624B702](#) [109P0624B7D01](#) [109P0624K702](#) [109P0624B701](#) [109P0612J702](#)  
[109P0612J7D01](#) [109P0624K701](#)