

DRA

Automotive grade

High power density, high efficiency, shielded drum core power inductors

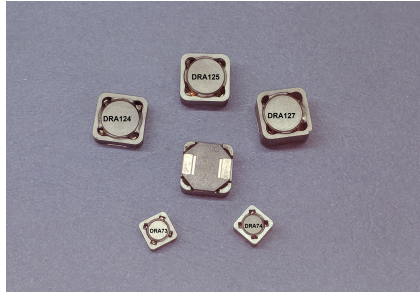

Product features

- AEC-Q200 qualified
- Five different mechanical sizes available
- Magnetically shielded-reduces EMI
- Ferrite core material
- Inductance range from 0.28 μ H to 1000 μ H
- Current range up to 56 A
- Rugged construction for high shock and vibration environments
- Moisture Sensitivity Level (MSL): 1

Applications

- Body electronics
 - Headlamps, tail lamps and interior lighting
 - Heating Ventilation and Air Conditioning controllers (HVAC)
 - Doors, window lift and seat control
- Advanced driver assistance systems
 - Adaptive cruise control (ACC)
 - Collision avoidance system
 - Car black box system
- Infotainment and cluster electronics
 - Audio subsystem: head unit and trunk amp
 - Digital instrument cluster
 - In-Vehicle Infotainment (IVI) and navigation
- Chassis and safety electronics
 - Electronic Stability Control system (ESC)
 - Electric parking brake
 - Electronic Power Steering (EPS)
- Engine and powertrain systems
 - Diesel/gasoline engine management
 - Powertrain Control Module (PCM)/ Engine Control Unit (ECU)
 - Transmission Control Unit (TCU)

Environmental data

- Storage temperature range (component): -40 °C to +165 °C
- Operating temperature range: -40 °C to +165 °C (ambient plus self-temperature rise)
- Solder reflow temperature: J-STD-020 (latest revision) compliant



High power density, high efficiency, shielded drum core power inductors

Product specifications

Part Number ⁶	OCL ¹ ±20% (μH)	I _{rms} ² (A)	I _{sat} ¹³ (A)	I _{sat} ²⁴ (A)	DCR (Ω) @ +25 °C		K-Factor ⁵
					Typical	Maximum	
DRA73-R33-R	0.29	8.42	14.8	11.8	0.0040	0.0048	636.5
DRA73-1R0-R	0.91	6.50	8.22	6.58	0.0067	0.0080	353.6
DRA73-1R5-R	1.36	5.39	6.73	5.38	0.0097	0.0117	289.3
DRA73-2R2-R	2.52	4.18	4.93	3.95	0.016	0.019	212.2
DRA73-3R3-R	3.18	3.59	4.35	3.48	0.022	0.026	187.2
DRA73-4R7-R	4.86	2.92	3.52	2.82	0.033	0.040	151.6
DRA73-6R8-R	6.63	2.62	2.96	2.37	0.041	0.049	127.3
DRA73-8R2-R	8.06	2.30	2.74	2.19	0.053	0.064	117.9
DRA73-100-R	10.27	2.11	2.39	1.91	0.064	0.077	102.7
DRA73-150-R	14.98	1.74	2.00	1.60	0.094	0.112	86.0
DRA73-220-R	22.39	1.42	1.64	1.32	0.141	0.170	70.7
DRA73-330-R	31.84	1.25	1.35	1.08	0.183	0.219	57.9
DRA73-470-R	47.83	1.02	1.10	0.884	0.275	0.330	47.5
DRA73-680-R	66.89	0.845	0.937	0.749	0.397	0.476	40.3
DRA73-820-R	83.77	0.731	0.851	0.680	0.530	0.636	36.6
DRA73-101-R	101.7	0.682	0.763	0.610	0.609	0.731	32.8
DRA73-151-R	151.1	0.551	0.632	0.506	0.932	1.12	27.2
DRA73-221-R	218.8	0.479	0.510	0.408	1.23	1.48	21.9
DRA73-331-R	326.4	0.391	0.423	0.338	1.85	2.22	18.2
DRA73-471-R	472.6	0.326	0.354	0.283	2.67	3.20	15.2
DRA73-681-R	682.9	0.270	0.297	0.238	3.89	4.66	12.8
DRA73-821-R	825.3	0.252	0.267	0.214	4.46	5.35	11.5
DRA73-102-R	991.9	0.235	0.239	0.192	5.15	6.18	10.3

1. Open Circuit Inductance (OCL) Test Parameters: 100 kHz, 0.25 V_{rms}, 0.0A dc @ +25 °C
2. I_{rms}²: DC current for an approximate temperature rise of 40 °C without core loss. Derating is necessary for AC currents. PCB layout, trace thickness and width, air-flow and proximity of other heat generating components will affect the temperature rise. It is recommended that the temperature of the part not exceed +165 °C under worst case operating conditions verified in the end application.
3. I_{sat}¹: Peak current for approximately 30% rolloff at +25 °C.

4. I_{sat}²: Peak current for approximately 40% rolloff at +125 °C.
5. K-factor: Used to determine B_{p-p} for core loss (see graph). B_{p-p} = K * L * ΔI.
B_{p-p}:(Gauss), K: (K-factor from table), L: (Inductance in μH), ΔI (peak-to-peak ripple current in amps).
6. Part Number Definition: DRAxxx-yyy-R
 - DRAxxx = Product code and size
 - yyy= Inductance value in uH, R = decimal point, if no R is present then third character = number of zeros.
 - -R suffix = RoHS compliant

Product specifications

Part Number ⁶	OCL ¹ ±20% (µH)	I _{rms} ² (A)	I _{sat} ¹³ (A)	I _{sat} ²⁴ (A)	DCR (Ω) @ +25 °C Typical	DCR (Ω) @ +25 °C Maximum	K-Factor ⁵
DRA74-R33-R	0.29	7.26	18.4	14.7	0.0054	0.0064	547.9
DRA74-1R0-R	0.90	6.01	10.2	8.18	0.0078	0.0094	304.4
DRA74-1R5-R	1.31	5.55	8.36	6.69	0.0092	0.0110	249.0
DRA74-2R2-R	2.33	4.82	6.13	4.91	0.012	0.015	182.6
DRA74-3R3-R	3.05	4.16	5.41	4.33	0.016	0.020	161.1
DRA74-4R7-R	4.68	3.41	4.38	3.50	0.024	0.029	130.4
DRA74-6R8-R	6.51	2.91	3.68	2.94	0.034	0.040	109.6
DRA74-8R2-R	8.51	2.66	3.17	2.54	0.040	0.048	94.5
DRA74-100-R	9.62	2.56	2.97	2.37	0.043	0.052	88.4
DRA74-150-R	15.14	2.06	2.36	1.89	0.067	0.080	70.2
DRA74-220-R	22.25	1.68	1.96	1.57	0.100	0.120	58.3
DRA74-330-R	33.21	1.37	1.61	1.29	0.151	0.181	48.1
DRA74-470-R	46.56	1.14	1.37	1.10	0.219	0.263	40.9
DRA74-680-R	68.37	0.996	1.11	0.887	0.286	0.343	33.0
DRA74-820-R	81.45	0.879	1.03	0.827	0.367	0.440	30.8
DRA74-101-R	98.50	0.822	0.929	0.743	0.419	0.503	27.7
DRA74-151-R	150.9	0.661	0.748	0.598	0.648	0.780	22.3
DRA74-221-R	218.9	0.544	0.626	0.501	0.960	1.15	18.6
DRA74-331-R	328.9	0.435	0.514	0.411	1.50	1.79	15.3
DRA74-471-R	471.5	0.383	0.420	0.336	1.93	2.31	12.5
DRA74-681-R	682.8	0.315	0.352	0.282	2.86	3.43	10.5
DRA74-821-R	815.0	0.279	0.327	0.262	3.63	4.35	9.7
DRA74-102-R	1001.7	0.260	0.292	0.234	4.19	5.02	8.7

1. Open Circuit Inductance (OCL) Test Parameters: 100 kHz, 0.25 V_{rms}, 0.0 Adc @ +25 °C
2. I_{rms}: DC current for an approximate temperature rise of 40 °C without core loss. Derating is necessary for AC currents. PCB layout, trace thickness and width, air-flow and proximity of other heat generating components will affect the temperature rise. It is recommended that the temperature of the part not exceed +165 °C under worst case operating conditions verified in the end application.
3. I_{sat}¹: Peak current for approximately 30% rolloff at +25 °C.

4. I_{sat}²: Peak current for approximately 40% rolloff at +125 °C.
5. K-factor: Used to determine B_{p-p} for core loss (see graph). $B_{p-p} = K * L * \Delta I$. B_{p-p}:(Gauss), K: (K-factor from table), L: (Inductance in µH), ΔI (peak-to-peak ripple current in amps).
6. Part Number Definition: DRAxxx-yyy-R
 - DRAxxx = Product code and size
 - yyy= Inductance value in uH, R = decimal point, if no R is present then third character = number of zeros.
 - -R suffix = RoHS compliant

High power density, high efficiency, shielded drum core power inductors

Product specifications

Part Number ⁶	OCL ¹ ±20% (μH)	I_{rms}^2 (A)	I_{sat}^1 (A)	I_{sat}^2 (A)	DCR (Ω) @ +25 °C Typical	DCR (Ω) @ +25 °C Maximum	K-Factor ⁵
DRA124-R47-R	0.42	13.5	30.8	24.6	0.0024	0.0028	196.9
DRA124-1R0-R	0.82	11.7	22.0	17.6	0.0031	0.0038	140.7
DRA124-1R5-R	1.36	9.36	17.1	13.7	0.0049	0.0058	109.4
DRA124-2R2-R	2.04	7.64	14.0	11.2	0.0070	0.0090	89.5
DRA124-3R3-R	2.79	6.94	11.9	9.48	0.0090	0.011	75.7
DRA124-4R7-R	4.74	5.47	9.06	7.25	0.014	0.017	57.9
DRA124-6R8-R	7.28	4.46	7.33	5.87	0.021	0.026	46.9
DRA124-8R2-R	8.88	3.87	6.70	5.36	0.028	0.034	42.8
DRA124-100-R	10.37	3.67	6.16	4.93	0.031	0.038	39.4
DRA124-150-R	14.10	3.10	5.31	4.25	0.044	0.053	34.0
DRA124-220-R	23.00	2.44	4.16	3.33	0.071	0.086	26.6
DRA124-330-R	34.13	1.98	3.42	2.74	0.108	0.130	21.9
DRA124-470-R	46.27	1.78	2.91	2.33	0.134	0.160	18.6
DRA124-680-R	69.77	1.45	2.37	1.90	0.201	0.241	15.1
DRA124-820-R	80.57	1.29	2.23	1.79	0.257	0.309	14.3
DRA124-101-R	98.80	1.20	2.00	1.60	0.296	0.355	12.8
DRA124-151-R	151.7	0.967	1.62	1.30	0.454	0.550	10.4
DRA124-221-R	209.6	0.865	1.36	1.09	0.568	0.680	8.7
DRA124-331-R	326.9	0.690	1.09	0.874	0.892	1.070	7.0
DRA124-471-R	473.0	0.568	0.911	0.729	1.32	1.58	5.8
DRA124-681-R	682.1	0.466	0.759	0.607	1.96	2.35	4.9
DRA124-821-R	826.7	0.406	0.697	0.557	2.57	3.09	4.5
DRA124-102-R	1001.0	0.380	0.629	0.503	2.94	3.52	4.0

1. Open Circuit Inductance (OCL) Test Parameters: 100 kHz, 0.25 V_{rms}, 0.0 Adc @ +25 °C
2. I_{rms}^2 : DC current for an approximate temperature rise of 40 °C without core loss. Derating is necessary for AC currents. PCB layout, trace thickness and width, air-flow and proximity of other heat generating components will affect the temperature rise. It is recommended that the temperature of the part not exceed +165 °C under worst case operating conditions verified in the end application.
3. I_{sat}^1 : Peak current for approximately 30% rolloff at +25 °C.

4. I_{sat}^2 : Peak current for approximately 40% rolloff at +125 °C.
5. K-factor: Used to determine B_{p-p} for core loss (see graph). $B_{p-p} = K * L * \Delta I$. B_{p-p}: (Gauss), K: (K-factor from table), L: (Inductance in μH), ΔI (peak-to-peak ripple current in amps).
6. Part Number Definition: DRAxxx-yyy-R
 - DRAxxx = Product code and size
 - yyy= Inductance value in μH, R = decimal point, if no R is present then third character = number of zeros.
 - -R suffix = RoHS compliant

Product specifications

Part Number ⁶	OCL ¹	I_{rms}^2	I_{sat}^1	I_{sat}^2	DCR (Ω) @ +25 °C	DCR (Ω) @ +25 °C	K-Factor ⁵
	$\pm 20\%$ (μH)	(A)	(A)	(A)	Typical	Maximum	
DRA125-R47-R	0.45	14.7	33.2	26.6	0.0025	0.0030	176.9
DRA125-1R0-R	0.85	12.7	23.7	19.0	0.0034	0.0042	126.4
DRA125-1R5-R	1.41	12.9	18.4	14.8	0.0033	0.0039	98.3
DRA125-2R2-R	2.12	10.6	15.1	12.1	0.0048	0.0058	80.4
DRA125-3R3-R	2.89	8.63	12.8	10.2	0.0073	0.0087	68.0
DRA125-4R7-R	4.90	7.67	9.76	7.81	0.0092	0.011	52.0
DRA125-6R8-R	6.23	6.81	8.74	6.99	0.012	0.014	46.6
DRA125-8R2-R	7.49	6.41	7.90	6.32	0.013	0.016	42.1
DRA125-100-R	9.22	5.57	7.22	5.77	0.017	0.021	38.5
DRA125-150-R	14.67	4.45	5.72	4.58	0.027	0.033	30.5
DRA125-220-R	20.65	3.95	4.74	3.79	0.035	0.042	25.3
DRA125-330-R	31.47	3.19	3.86	3.09	0.053	0.064	20.6
DRA125-470-R	47.83	2.59	3.13	2.51	0.081	0.097	16.7
DRA125-680-R	68.48	2.13	2.64	2.11	0.120	0.144	14.0
DRA125-820-R	80.86	2.01	2.41	1.93	0.135	0.162	12.8
DRA125-101-R	97.60	1.75	2.21	1.77	0.178	0.214	11.8
DRA125-151-R	150.0	1.41	1.79	1.43	0.273	0.330	9.5
DRA125-221-R	222.8	1.14	1.47	1.18	0.416	0.500	7.8
DRA125-331-R	325.1	1.00	1.19	0.96	0.543	0.650	6.4
DRA125-471-R	466.3	0.826	1.01	0.805	0.790	0.950	5.4
DRA125-681-R	683.3	0.673	0.834	0.667	1.200	1.440	4.4
DRA125-821-R	813.6	0.632	0.758	0.606	1.360	1.630	4.0
DRA125-102-R	992.8	0.552	0.695	0.556	1.780	2.130	3.7

1. Open Circuit Inductance (OCL) Test Parameters: 100 kHz, 0.25 V_{rms}, 0.0 Adc @ +25 °C
2. I_{rms}^2 : DC current for an approximate temperature rise of 40 °C without core loss. Derating is necessary for AC currents. PCB layout, trace thickness and width, air-flow and proximity of other heat generating components will affect the temperature rise. It is recommended that the temperature of the part not exceed +165 °C under worst case operating conditions verified in the end application.
3. I_{sat}^1 : Peak current for approximately 30% rolloff at +25 °C.

4. I_{sat}^2 : Peak current for approximately 40% rolloff at +125 °C.
5. K-factor: Used to determine Bp-p for core loss (see graph). $B_{p-p} = K * L * \Delta I$. B_{p-p} :(Gauss), K: (K-factor from table), L: (Inductance in μH), ΔI (peak-to-peak ripple current in amps).
6. Part Number Definition: DRAxxx-yyy-R
 - DRAxxx = Product code and size
 - yyy= Inductance value in μH , R = decimal point, if no R is present then third character = number of zeros.
 - -R suffix = RoHS compliant

High power density, high efficiency, shielded drum core power inductors

Product specifications

Part Number ⁶	OCL ¹ ±20% (µH)	I _{rms} ² (A)	I _{sat} ¹ ³ (A)	I _{sat} ² ⁴ (A)	DCR (Ω) @ +25 °C Typical	DCR (Ω) @ +25 °C Maximum	K-Factor ⁵
DRA127-R47-R	0.41	15.9	56.0	44.8	0.0024	0.0030	120.0
DRA127-1R0-R	0.77	13.6	40.0	32.0	0.0034	0.0040	85.7
DRA127-1R5-R	1.27	12.2	31.1	24.9	0.0043	0.0051	66.7
DRA127-2R2-R	1.92	12.5	25.5	20.4	0.0040	0.0048	54.6
DRA127-3R3-R	3.51	8.54	18.7	14.9	0.0086	0.0104	40.0
DRA127-4R7-R	4.58	8.14	16.5	13.2	0.0094	0.011	35.3
DRA127-6R8-R	6.72	6.52	13.3	10.7	0.015	0.018	28.6
DRA127-8R2-R	8.33	6.33	12.2	9.74	0.016	0.019	26.1
DRA127-100-R	9.63	6.02	11.2	8.96	0.017	0.021	24.0
DRA127-150-R	14.90	4.83	9.03	7.23	0.027	0.032	19.4
DRA127-220-R	21.47	3.98	7.57	6.05	0.040	0.047	16.2
DRA127-330-R	32.01	3.22	6.22	4.98	0.060	0.072	13.3
DRA127-470-R	47.91	2.62	5.09	4.07	0.091	0.110	10.9
DRA127-680-R	68.22	2.33	4.18	3.34	0.115	0.138	9.0
DRA127-820-R	83.91	2.01	3.84	3.07	0.155	0.186	8.2
DRA127-101-R	100.8	1.89	3.46	2.77	0.175	0.210	7.4
DRA127-151-R	151.2	1.52	2.83	2.26	0.269	0.320	6.1
DRA127-221-R	219.8	1.25	2.35	1.88	0.398	0.480	5.0
DRA127-331-R	328.3	1.01	1.93	1.54	0.612	0.730	4.1
DRA127-471-R	474.5	0.827	1.62	1.29	0.910	1.10	3.5
DRA127-681-R	676.6	0.736	1.33	1.06	1.15	1.39	2.8
DRA127-821-R	824.6	0.637	1.22	0.978	1.54	1.85	2.6
DRA127-102-R	998.7	0.598	1.10	0.878	1.75	2.10	2.4

1. Open Circuit Inductance (OCL) Test Parameters: 100 kHz, 0.25 V_{rms}, 0.0 Adc @ +25 °C
2. I_{rms}: DC current for an approximate temperature rise of 40 °C without core loss. Derating is necessary for AC currents. PCB layout, trace thickness and width, air-flow and proximity of other heat generating components will affect the temperature rise. It is recommended that the temperature of the part not exceed +165 °C under worst case operating conditions verified in the end application.
3. I_{sat}¹: Peak current for approximately 30% rolloff at +25 °C.

4. I_{sat}²: Peak current for approximately 40% rolloff at +125 °C.
5. K-factor: Used to determine Bp-p for core loss (see graph). $B_{p-p} = K * L * \Delta I$.
B_{p-p}: (Gauss), K: (K-factor from table), L: (Inductance in µH), ΔI (peak-to-peak ripple current in amps).
6. Part Number Definition: DRAxxx-yyy-R
 - DRAxxx = Product code and size
 - yyy= Inductance value in µH, R = decimal point, if no R is present then third character = number of zeros.
 - -R suffix = RoHS compliant

Dimensions - mm

DRA73 & DRA74

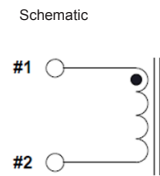
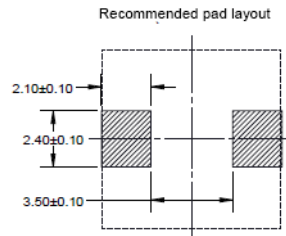
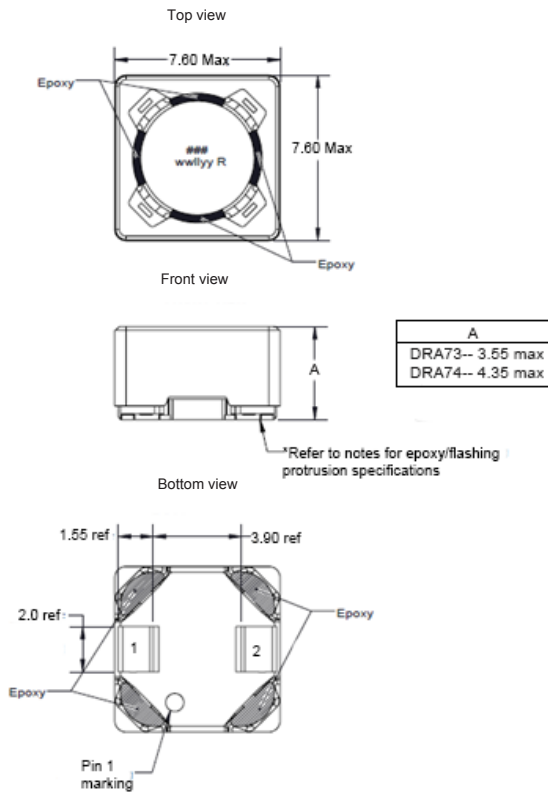

Part Marking: ### = inductance value in μH , R = decimal point; if no R is present, then 3rd digit equals number of zeros
wwlyy = Date code, R = revision level
All soldering surfaces to be coplanar within 0.10 millimeters
Tolerances are ± 0.2 millimeters unless stated otherwise.
Do not route traces or vias underneath the inductor
*Special Characteristic epoxy protrusion or any flashing from the plastic on the header/base can be below the terminal surface and must not exceed 0.08 mm beyond the bottom surface of the terminal.

DRA124, DRA125 & DRA127

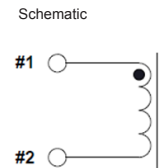
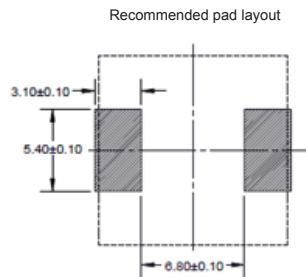
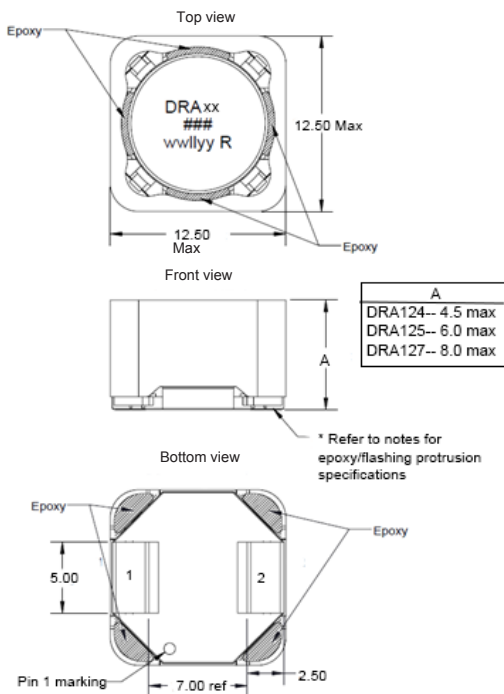

Part Marking: DRAXx, xx = 124, 125 or 127, ### = inductance value in μH , R = decimal point; if no R is present, then 3rd digit equals number of zeros
wwlyy = Date code, R = revision level
All soldering surfaces to be coplanar within 0.10 millimeters
Tolerances are ± 0.2 millimeters unless stated otherwise.
Do not route traces or vias underneath the inductor
*Special Characteristic epoxy protrusion or any flashing from the plastic on the header/base can be below the terminal surface and must not exceed 0.08 mm beyond the bottom surface of the terminal.

High power density, high efficiency, shielded drum core power inductors

Packaging information - mm

DRA73 & DRA74

Supplied in tape and reel packaging, on a 13" diameter reel:

- DRA73 - 1350 pieces
- DRA74 - 1100 pieces

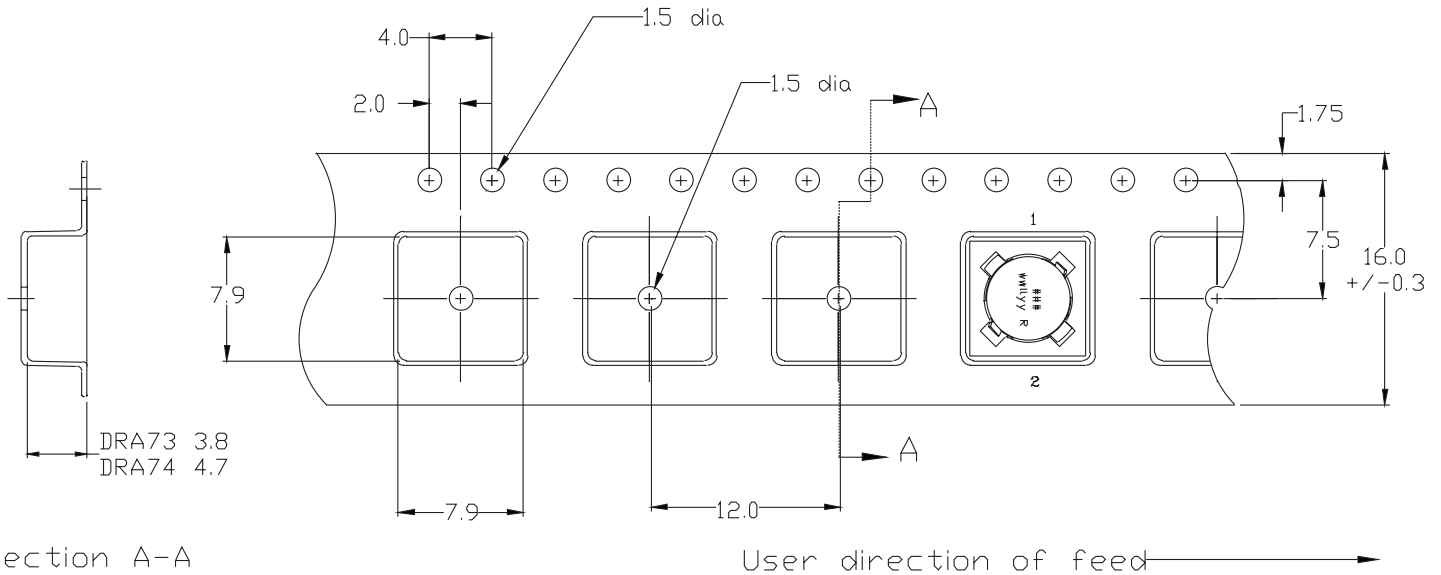

DRA124, DRA125 & DRA127

Supplied in tape and reel packaging, on a 13" diameter reel:

- DRA124 - 750 pieces
- DRA125 - 600 pieces
- DRA127 - 350 pieces

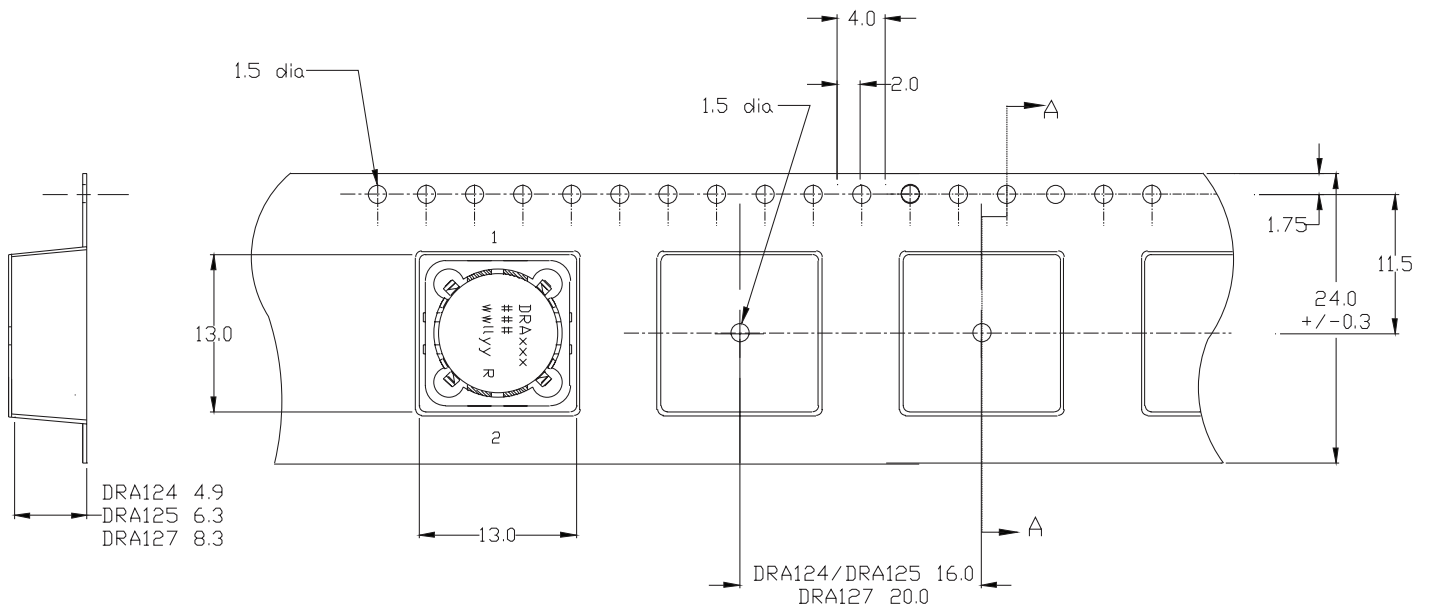

Temperature rise vs. total loss

DRA73

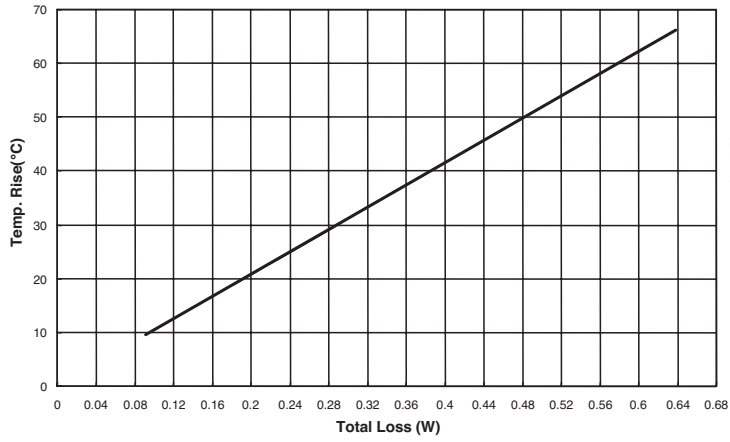

DRA74

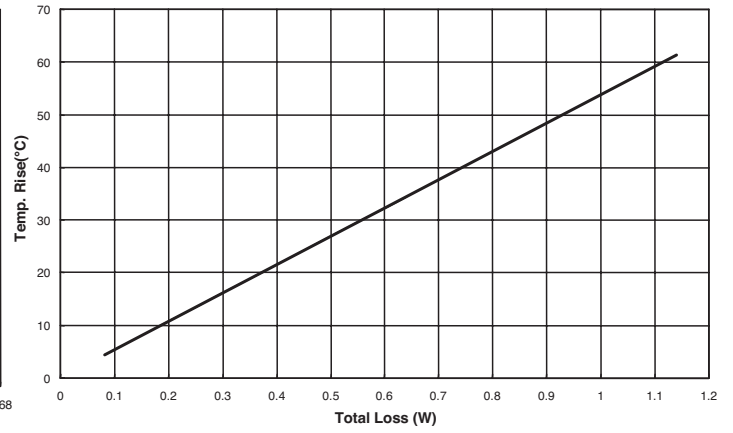

DRA124

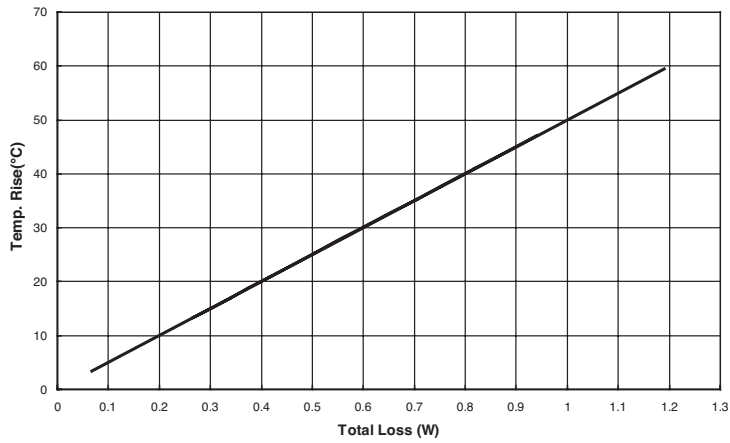

DRA125

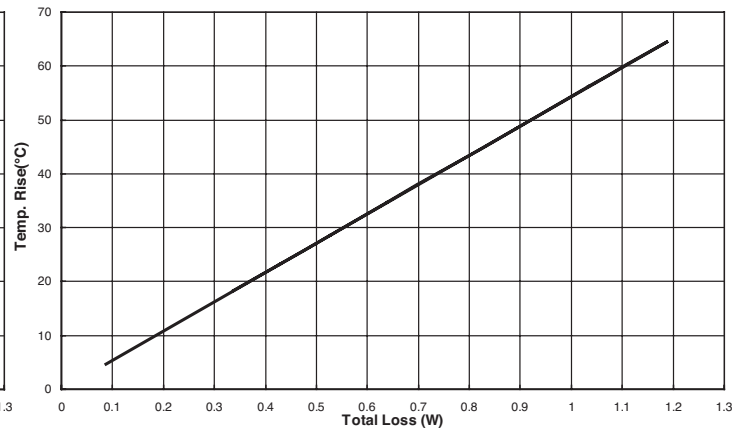

DRA127

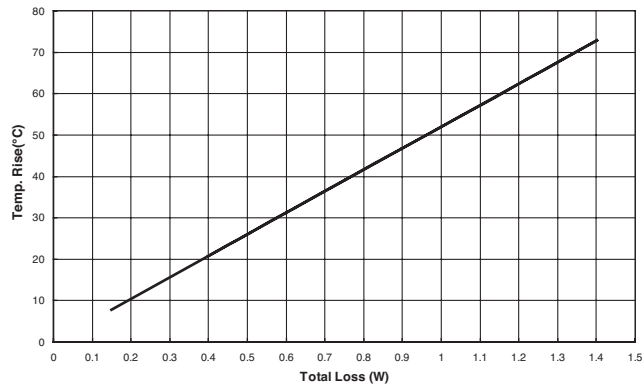

High power density, high efficiency, shielded drum core power inductors

Core loss vs. B_{p-p}

DRA73

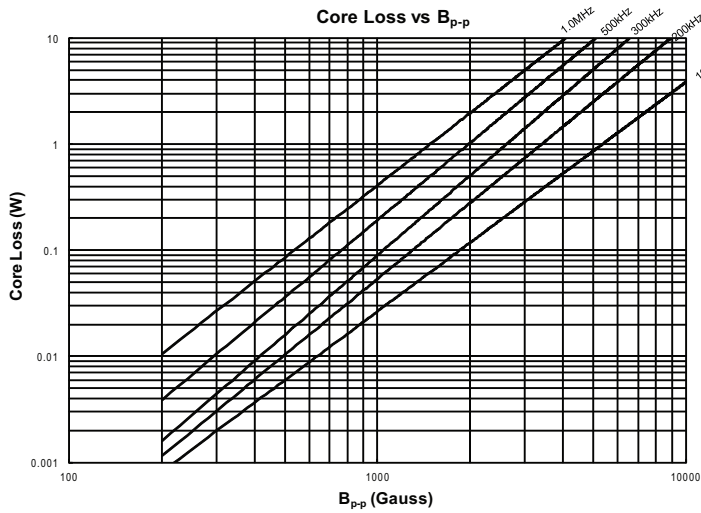

DRA74

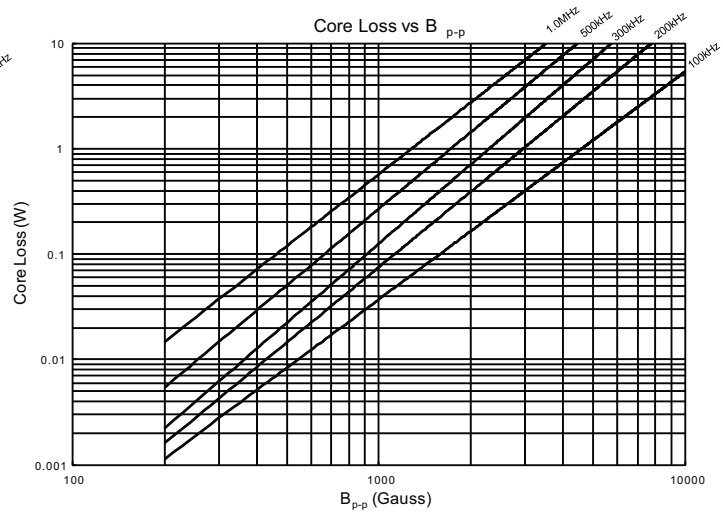

DRA124

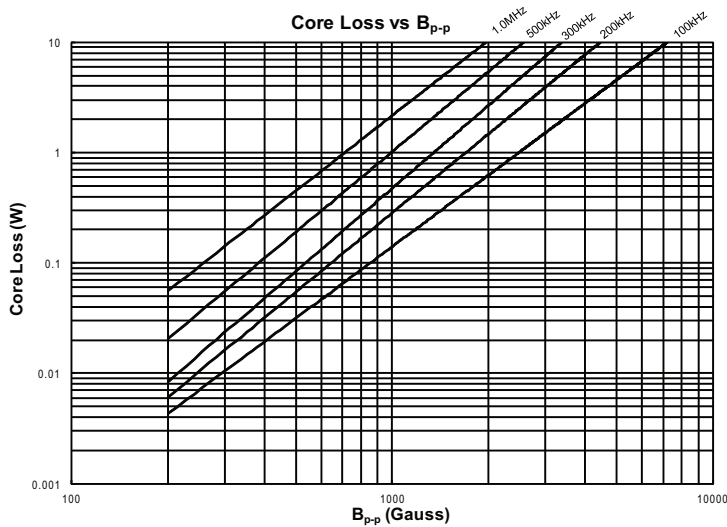

DRA125

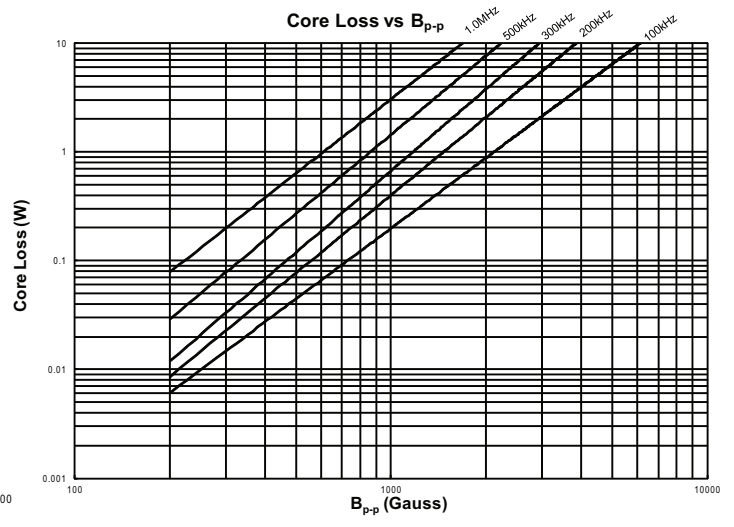

DRA127

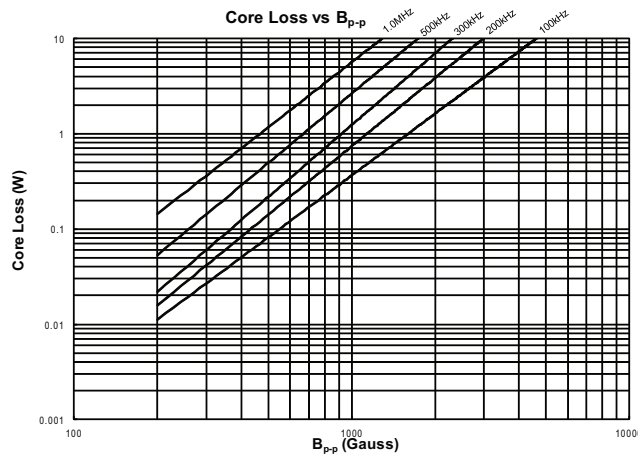

Inductance characteristics

DRA73

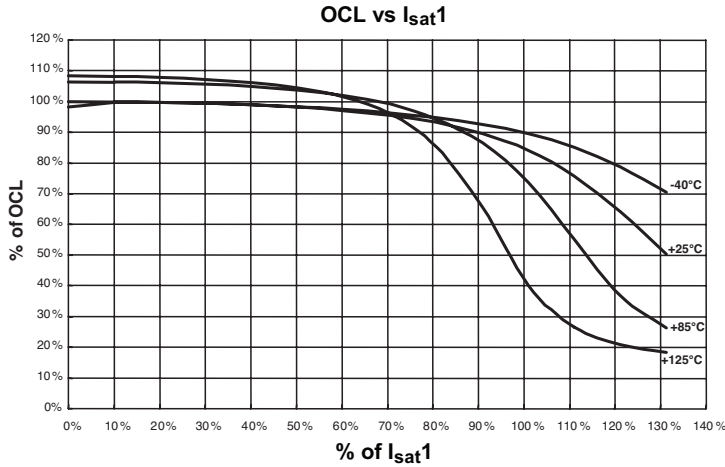

DRA74

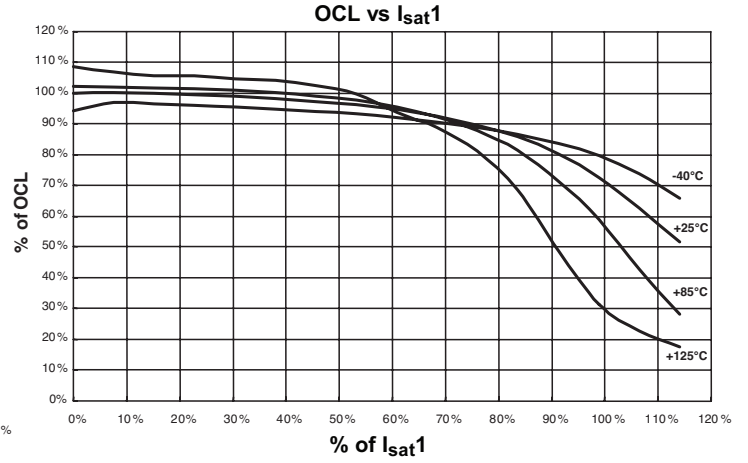

DRA124

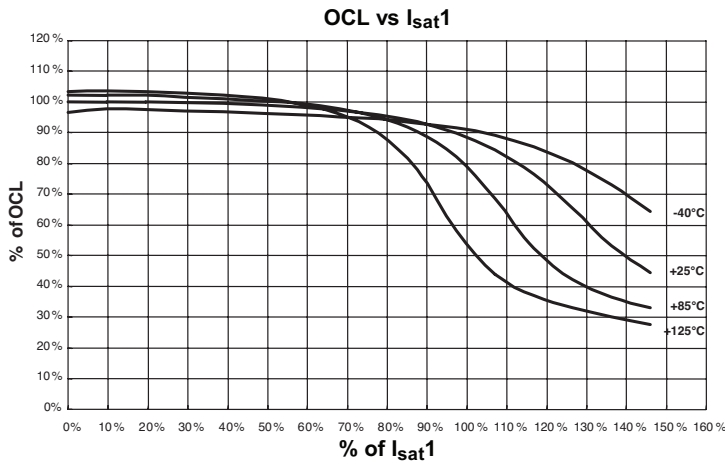

DRA125

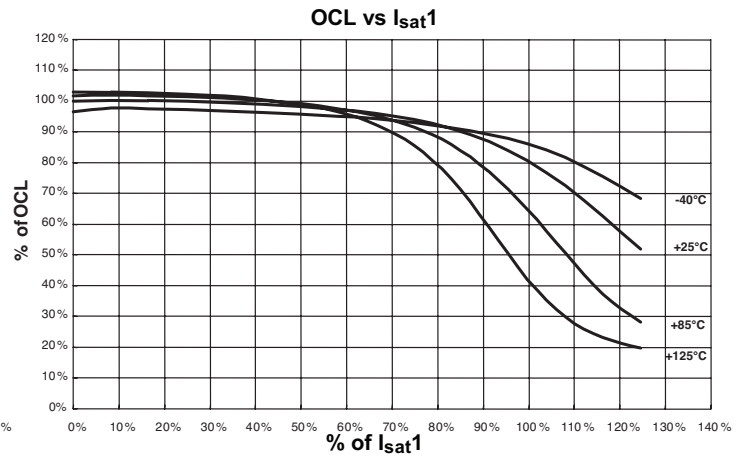

DRA127

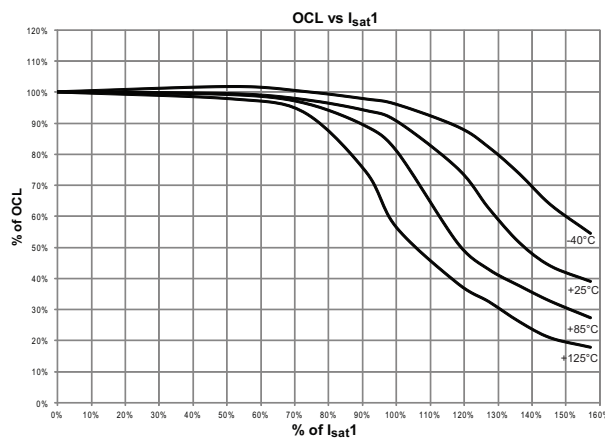

High power density, high efficiency, shielded drum core power inductors

Solder Reflow Profile

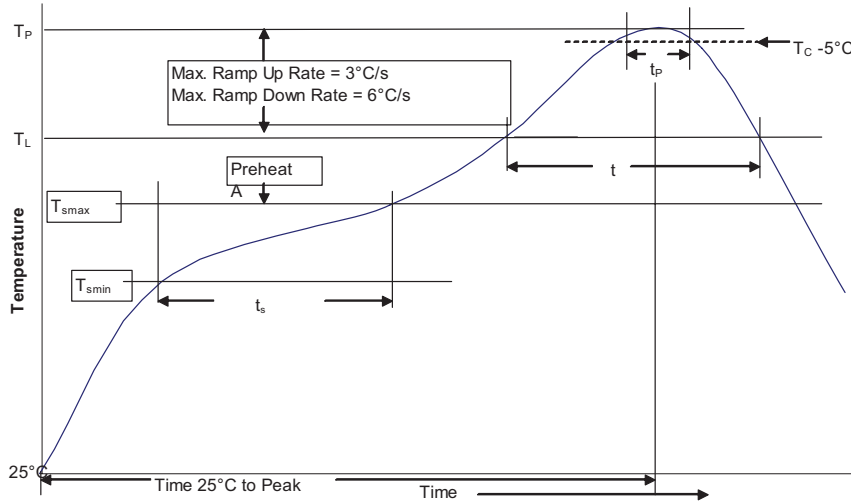

Table 1 - Standard SnPb Solder (T_c)

Package Thickness	Volume mm^3 <350	Volume mm^3 ≥ 350
<2.5mm	235°C	220°C
$\geq 2.5\text{mm}$	220°C	220°C

Table 2 - Lead (Pb) Free Solder (T_c)

Package Thickness	Volume mm^3 <350	Volume mm^3 350 - 2000	Volume mm^3 >2000
<1.6mm	260°C	260°C	260°C
1.6 – 2.5mm	260°C	250°C	245°C
>2.5mm	250°C	245°C	245°C

Reference JDEC J-STD-020

Profile Feature	Standard SnPb Solder	Lead (Pb) Free Solder
Preheat and Soak	• Temperature min. (T_{smin})	100°C
	• Temperature max. (T_{smax})	150°C
	• Time (T_{smin} to T_{smax}) (t_s)	60-120 Seconds
Average ramp up rate T_{smax} to T_p	3°C/ Second Max.	3°C/ Second Max.
Liquidous temperature (T_L)	183°C	217°C
Time at liquidous (t_L)	60-150 Seconds	60-150 Seconds
Peak package body temperature (T_p)*	Table 1	Table 2
Time (t_p)** within 5 °C of the specified classification temperature (T_c)	20 Seconds**	30 Seconds**
Average ramp-down rate (T_p to T_{smax})	6°C/ Second Max.	6°C/ Second Max.
Time 25°C to Peak Temperature	6 Minutes Max.	8 Minutes Max.

* Tolerance for peak profile temperature (T_p) is defined as a supplier minimum and a user maximum.

** Tolerance for time at peak profile temperature (t_p) is defined as a supplier minimum and a user maximum.

Life Support Policy: Eaton does not authorize the use of any of its products for use in life support devices or systems without the express written approval of an officer of the Company. Life support systems are devices which support or sustain life, and whose failure to perform, when properly used in accordance with instructions for use provided in the labeling, can be reasonably expected to result in significant injury to the user.

Eaton reserves the right, without notice, to change design or construction of any products and to discontinue or limit distribution of any products. Eaton also reserves the right to change or update, without notice, any technical information contained in this bulletin.

Eaton
Electronics Division
1000 Eaton Boulevard
Cleveland, OH 44122
United States
www.eaton.com/electronics

© 2018 Eaton
All Rights Reserved
Printed in USA
Publication No. 4319 BU-MC17080
January 2018

Eaton is a registered trademark.

All other trademarks are property of their respective owners.

Mouser Electronics

Authorized Distributor

Click to View Pricing, Inventory, Delivery & Lifecycle Information:

Eaton:

[DRA124-100-R](#) [DRA124-101-R](#) [DRA124-102-R](#) [DRA124-150-R](#) [DRA124-151-R](#) [DRA124-1R0-R](#) [DRA124-1R5-R](#)
[DRA124-220-R](#) [DRA124-221-R](#) [DRA124-2R2-R](#) [DRA124-330-R](#) [DRA124-331-R](#) [DRA124-3R3-R](#) [DRA124-470-R](#)
[DRA124-471-R](#) [DRA124-4R7-R](#) [DRA124-680-R](#) [DRA124-681-R](#) [DRA124-6R8-R](#) [DRA124-820-R](#) [DRA124-821-R](#)
[DRA124-8R2-R](#) [DRA124-R47-R](#) [DRA125-100-R](#) [DRA125-101-R](#) [DRA125-102-R](#) [DRA125-150-R](#) [DRA125-151-R](#)
[DRA125-1R0-R](#) [DRA125-1R5-R](#) [DRA125-220-R](#) [DRA125-221-R](#) [DRA125-2R2-R](#) [DRA125-330-R](#) [DRA125-331-R](#)
[DRA125-3R3-R](#) [DRA125-470-R](#) [DRA125-471-R](#) [DRA125-4R7-R](#) [DRA125-680-R](#) [DRA125-681-R](#) [DRA125-6R8-R](#)
[DRA125-820-R](#) [DRA125-821-R](#) [DRA125-8R2-R](#) [DRA125-R47-R](#) [DRA127-100-R](#) [DRA127-101-R](#) [DRA127-102-R](#)
[DRA127-150-R](#) [DRA127-151-R](#) [DRA127-1R0-R](#) [DRA127-1R5-R](#) [DRA127-220-R](#) [DRA127-221-R](#) [DRA127-2R2-R](#)
[DRA127-330-R](#) [DRA127-331-R](#) [DRA127-3R3-R](#) [DRA127-470-R](#) [DRA127-471-R](#) [DRA127-4R7-R](#) [DRA127-680-R](#)
[DRA127-681-R](#) [DRA127-6R8-R](#) [DRA127-820-R](#) [DRA127-821-R](#) [DRA127-8R2-R](#) [DRA127-R47-R](#) [DRA73-100-R](#)
[DRA73-101-R](#) [DRA73-102-R](#) [DRA73-150-R](#) [DRA73-151-R](#) [DRA73-1R0-R](#) [DRA73-1R5-R](#) [DRA73-220-R](#) [DRA73-](#)
[221-R](#) [DRA73-2R2-R](#) [DRA73-330-R](#) [DRA73-331-R](#) [DRA73-3R3-R](#) [DRA73-470-R](#) [DRA73-471-R](#) [DRA73-4R7-R](#)
[DRA73-680-R](#) [DRA73-681-R](#) [DRA73-6R8-R](#) [DRA73-820-R](#) [DRA73-821-R](#) [DRA73-8R2-R](#) [DRA73-R33-R](#) [DRA74-](#)
[100-R](#) [DRA74-101-R](#) [DRA74-102-R](#) [DRA74-150-R](#) [DRA74-151-R](#) [DRA74-1R0-R](#) [DRA74-1R5-R](#) [DRA74-220-R](#)