

CD40175B Types

CMOS Quad 'D'-Type Flip-Flop

High-Voltage Types (20-Volt Rating)

Features:

- 100% tested for quiescent current at 20 V
- Maximum input current of 1 μ A at 18 V over full package-temperature range; 100 nA at 18 V and 25°C
- Noise margin (full package-temperature range) =
1 V at $V_{DD} = 5$ V
2 V at $V_{DD} = 10$ V
2.5 V at $V_{DD} = 15$ V
- 5-V, 10-V, and 15-V parametric ratings

- Meets all requirements of JEDEC Tentative Standard No. 13B, "Standard Specifications for Description of 'B' Series CMOS Devices"
- Output compatible with two HTL loads, two low power TTL loads, or one low power Schottky TTL load
- Functional equivalent to TTL 74175
- Standardized symmetrical output characteristics

Applications:

- Shift registers
- Buffer/storage registers
- Pattern generators

■ CD40175B consists of four identical D-type flip-flops. Each flip-flop has an independent DATA D input and complementary Q and \bar{Q} outputs. The CLOCK and CLEAR inputs are common to all flip-flops. Data are transferred to the Q outputs on the positive-going transition of the clock pulse. All four flip-flops are simultaneously reset by a low level on the CLEAR input.

These devices can function as shift register elements or as T-type flip-flops for toggle and counter applications.

The CD40175B types are supplied in 16-lead hermetic dual-in-line ceramic packages (F3A suffix), 16-lead dual-in-line plastic packages (E suffix), 16-lead small-outline packages (M, M96, MT, and NSR suffixes), and 16-lead thin shrink small-outline packages (PW and PWR suffixes).

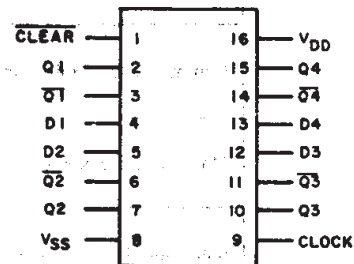
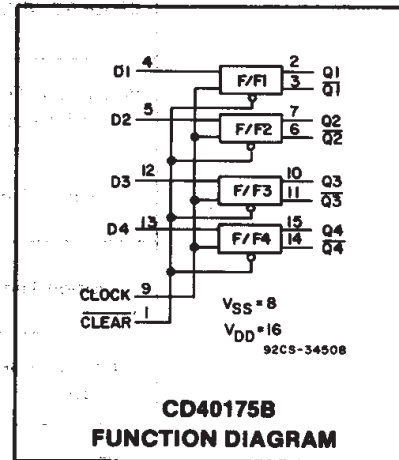

V_{DD} = PIN 16
 V_{SS} = PIN 8
92CS-34507

TERMINAL ASSIGNMENT

MAXIMUM RATINGS, Absolute-Maximum Values:

DC SUPPLY-VOLTAGE RANGE, (V_{DD})	-0.5V to +20V
Voltages referenced to V_{SS} Terminal	
INPUT VOLTAGE RANGE, ALL INPUTS	-0.5V to V_{DD} +0.5V
DC INPUT CURRENT, ANY ONE INPUT	\pm 10mA
POWER DISSIPATION PER PACKAGE (P_D):		
For $T_A = -55^\circ\text{C}$ to $+100^\circ\text{C}$	500mW
For $T_A = +100^\circ\text{C}$ to $+125^\circ\text{C}$	Derate Linearly at 12mW/ $^\circ\text{C}$ to 200mW
DEVICE DISSIPATION PER OUTPUT TRANSISTOR		
FOR T_A = FULL PACKAGE-TEMPERATURE RANGE (All Package-Types)	100mW
OPERATING-TEMPERATURE RANGE (T_A)	-55°C to $+125^\circ\text{C}$
STORAGE TEMPERATURE RANGE (T_{stg})	-65°C to $+150^\circ\text{C}$
LEAD TEMPERATURE (DURING SOLDERING):		
At distance 1/16 \pm 1/32 inch (1.59 \pm 0.79mm) from case for 10s max	$+265^\circ\text{C}$

CD40175B Types

RECOMMENDED OPERATING CONDITIONS at $T_A = 25^\circ\text{C}$, Except as Noted.

For maximum reliability, nominal operating conditions should be selected so that operation is always within the following ranges:

CHARACTERISTIC	V _{DD} (V)	LIMITS		UNITS
		MIN.	MAX.	
Supply-Voltage Range (For $T_A =$ Full Package-Temperature Range)	—	3	18	V
Data Setup Time	5	120	—	ns
	10	50	—	
	15	40	—	
Data Hold Time	5	80	—	ns
	10	40	—	
	15	30	—	
Clock Input Frequency	5	—	2	MHz
	10	dc	5	
	15	—	6.5	
Clock Input Rise or Fall Time	5	—	15	μs
	10	—	15	
	15	—	15	
Clock Input Pulse Width	5	250	—	ns
	10	100	—	
	15	75	—	
Clear Pulse Width	5	200	—	ns
	10	80	—	
	15	60	—	
Clear Removal Time	5	250	—	ns
	10	100	—	
	15	80	—	

3
COMMERCIAL CMOS
HIGH VOLTAGE ICs



Fig. 1 - Logic diagram (1 of 4 flip-flops).

CD40175B Types

STATIC ELECTRICAL CHARACTERISTICS

CHARACTERISTIC	CONDITIONS			LIMITS AT INDICATED TEMPERATURES (°C)							UNITS
	V _O (V)	V _{IN} (V)	V _{DD} (V)	-55	-40	+85	+125	+25			
								Min.	Typ.	Max.	
Quiescent Device Current Max. I _{DD}	—	0, 5	5	1	1	30	30	—	0.02	1	μA
	—	0, 10	10	2	2	60	60	—	0.02	2	
	—	0, 15	15	4	4	120	120	—	0.02	4	
	—	0, 20	20	20	20	600	600	—	0.04	20	
Output Low (Sink) Current Min. I _{OL}	0.4	0, 5	5	0.64	0.61	0.42	0.36	0.51	1	—	mA
	0.5	0, 10	10	1.6	1.5	1.1	0.9	1.3	2.6	—	
	1.5	0, 15	15	4.2	4	2.8	2.4	3.4	6.8	—	
Output High (Source) Current Min. I _{OH}	4.6	0, 5	5	-0.64	-0.61	-0.42	-0.36	-0.51	-1	—	mA
	2.5	0, 5	5	-2	-1.8	-1.3	-1.15	-1.6	-3.2	—	
	9.5	0, 10	10	-1.6	-1.5	-1.1	-0.9	-1.3	-2.6	—	
	13.5	0, 15	15	-4.2	-4	-2.8	-2.4	-3.4	-6.8	—	
Output Voltage: Low-Level Max. V _{OL}	—	0, 5	5	0.05				—	0	0.05	V
	—	0, 10	10	0.05				—	0	0.05	
	—	0, 15	15	0.05				—	0	0.05	
Output Voltage: High-Level Min. V _{OH}	—	0, 5	5	4.95				4.95	5	—	V
	—	0, 10	10	9.95				9.95	10	—	
	—	0, 15	15	14.95				14.95	15	—	
Input Low Voltage Max. V _{IL}	0.5, 4.5	—	5	1.5				—	—	1.5	V
	1, 9	—	10	3				—	—	3	
	1.5, 13.5	—	15	4				—	—	4	
Input High Voltage Min. V _{IH}	0.5, 4.5	—	5	3.5				3.5	—	—	V
	1, 9	—	10	7				7	—	—	
	1.5, 13.5	—	15	11				11	—	—	
Input Current Max. I _{IN}	—	0, 18	18	±0.1	±0.1	±1	±1	—	±10 ⁻⁵	±0.1	μA



Fig. 2 - Definition of setup, hold, propagation delay, and removal times.

TRUTH TABLE FOR 1 OF 4 FLIP-FLOPS (Positive Logic)

INPUTS			OUTPUTS	
CLOCK	DATA	CLEAR	Q	\bar{Q}
	0	1	0	1
	1	1	1	0
	X	1	Q	\bar{Q}
X	X	0	0	1

1=High Level X=Don't Care 0=Low Level

CD40175B Types

DYNAMIC ELECTRICAL CHARACTERISTICS at TA = 25°C; input tr, tf = 20 ns, CL = 50 pF, RL = 200 kΩ

CHARACTERISTIC	TEST CONDITIONS VDD (V)	LIMITS			UNITS	
		MIN.	TYP.	MAX.		
Transition Time t _{THL} , t _{TLH}	5	—	100	200	ns	
	10	—	50	100		
	15	—	40	80		
Propagation Delay Time Clock to Q Output t _{PHL} , t _{PLH}	5	—	220	400		
	10	—	90	160		
	15	—	70	120		
Propagation Delay Time CLEAR to Q Output t _{PHL}	5	—	325	500		
	10	—	130	200		
	15	—	100	150		
Minimum Pulse Width Clock t _{WH}	5	—	110	250		
	10	—	45	100		
	15	—	35	75		
Clear t _{WL}	5	—	100	200		
	10	—	40	80		
	15	—	30	60		
Maximum Clock Frequency f _{CL}	5	2	4.5	—	MHz	
	10	5	11	—		
	15	6.5	14	—		
Maximum Clock Rise or Fall Time tr _{CL} , tf _{CL}	5	15	—	—	μs	
	10	15	—	—		
	15	15	—	—		
Minimum Data Setup Time t _{SU}	5	—	60	120	ns	
	10	—	25	50		
	15	—	20	40		
Minimum Data Hold Time t _H	5	—	40	80		
	10	—	20	40		
	15	—	15	30		
Minimum Clear Removal Time ‡ t _{REM}	5	—	125	250		
	10	—	50	100		
	15	—	40	80		
Input Capacitance C _{IN}	—	—	5	7.5		pF

**COMMERCIAL CMOS
HIGH VOLTAGE ICs**

‡ CLEAR signal must be high prior to positive-going transition of CLOCK pulse.

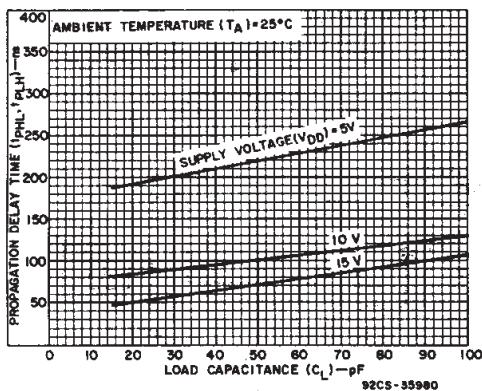

Fig. 3 - Typical propagation delay time (CLOCK to OUTPUT) as a function of load capacitance.

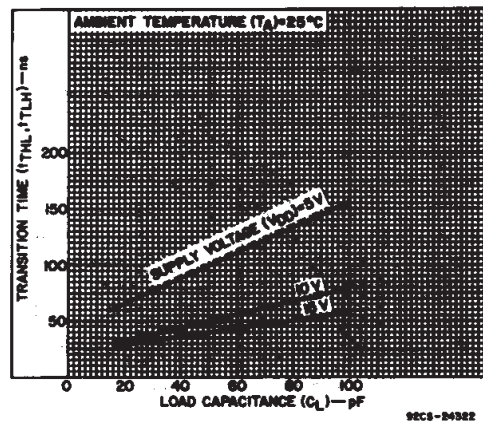

Fig. 4 - Typical transition time as a function of load capacitance.

CD40175B Types

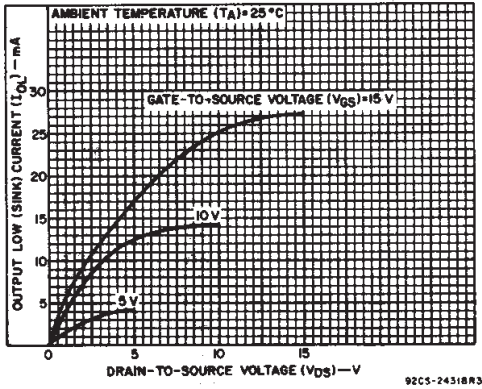

Fig. 5 - Typical output low (sink) current characteristics.

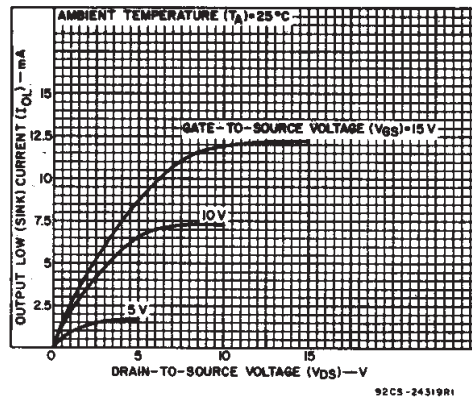

Fig. 6 - Minimum output low (sink) current characteristics.



Fig. 7 - Typical output high (source) current characteristics.

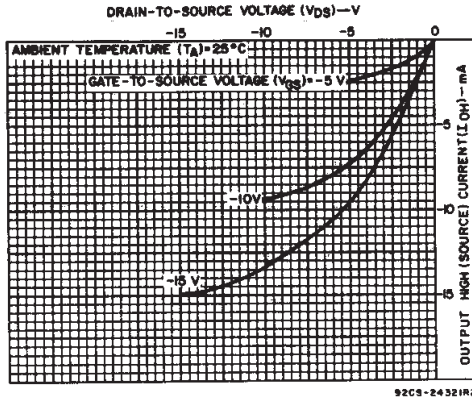

Fig. 8 - Minimum output high (source) current characteristics.



Fig. 9 - Typical dynamic power dissipation as a function of CLOCK frequency.

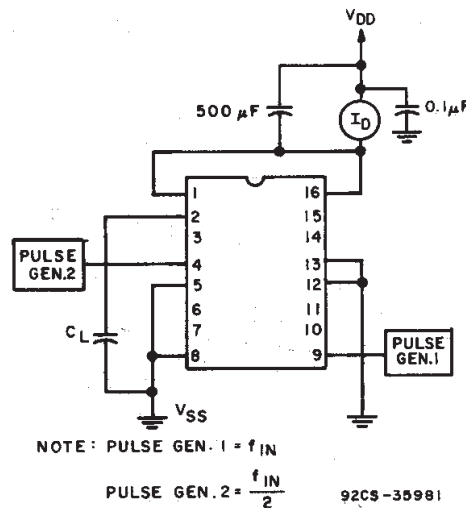

Fig. 10 - Dynamic power dissipation test circuit.

CD40175B Types

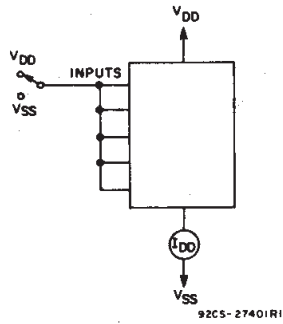

Fig. 11 - Quiescent device current test circuit.

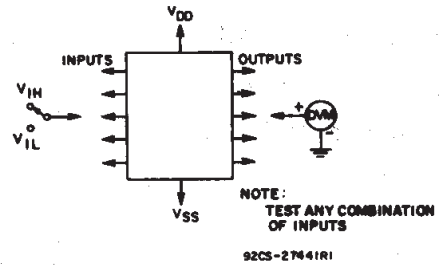

Fig. 12 - Noise immunity test circuit.

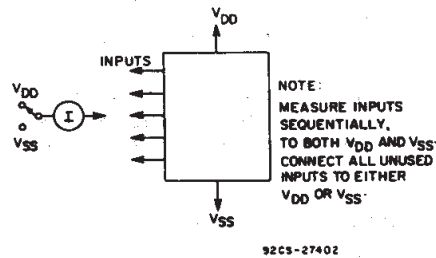
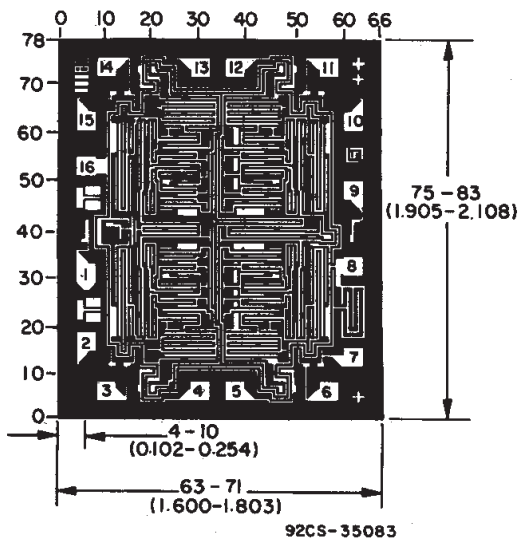

Fig. 13 - Input leakage current test circuit.



Dimensions and pad layout for CD40175BH.

Dimensions in parentheses are in millimeters and are derived from the basic inch dimensions as indicated. Grid graduations are in mils (10^{-3} inch).

PACKAGING INFORMATION

Orderable Device	Status (1)	Package Type	Package Drawing	Pins	Package Qty	Eco Plan (2)	Lead/Ball Finish (6)	MSL Peak Temp (3)	Op Temp (°C)	Device Marking (4/5)	Samples
CD40175BE	ACTIVE	PDIP	N	16	25	Green (RoHS & no Sb/Br)	NIPDAU	N / A for Pkg Type	-55 to 125	CD40175BE	Samples
CD40175BEE4	ACTIVE	PDIP	N	16	25	Green (RoHS & no Sb/Br)	NIPDAU	N / A for Pkg Type	-55 to 125	CD40175BE	Samples
CD40175BF3A	ACTIVE	CDIP	J	16	1	TBD	Call TI	N / A for Pkg Type	-55 to 125	CD40175BF3A	Samples
CD40175BM	ACTIVE	SOIC	D	16	40	Green (RoHS & no Sb/Br)	NIPDAU	Level-1-260C-UNLIM	-55 to 125	CD40175BM	Samples
CD40175BM96	ACTIVE	SOIC	D	16	2500	Green (RoHS & no Sb/Br)	NIPDAU	Level-1-260C-UNLIM	-55 to 125	CD40175BM	Samples
CD40175BMT	ACTIVE	SOIC	D	16	250	Green (RoHS & no Sb/Br)	NIPDAU	Level-1-260C-UNLIM	-55 to 125	CD40175BM	Samples
CD40175BNSR	ACTIVE	SO	NS	16	2000	Green (RoHS & no Sb/Br)	NIPDAU	Level-1-260C-UNLIM	-55 to 125	CD40175B	Samples
CD40175BPWR	ACTIVE	TSSOP	PW	16	2000	Green (RoHS & no Sb/Br)	NIPDAU	Level-1-260C-UNLIM	-55 to 125	CM0175B	Samples

(1) The marketing status values are defined as follows:

ACTIVE: Product device recommended for new designs.

LIFEBUY: TI has announced that the device will be discontinued, and a lifetime-buy period is in effect.

NRND: Not recommended for new designs. Device is in production to support existing customers, but TI does not recommend using this part in a new design.

PREVIEW: Device has been announced but is not in production. Samples may or may not be available.

OBSOLETE: TI has discontinued the production of the device.

(2) **RoHS:** TI defines "RoHS" to mean semiconductor products that are compliant with the current EU RoHS requirements for all 10 RoHS substances, including the requirement that RoHS substance do not exceed 0.1% by weight in homogeneous materials. Where designed to be soldered at high temperatures, "RoHS" products are suitable for use in specified lead-free processes. TI may reference these types of products as "Pb-Free".

RoHS Exempt: TI defines "RoHS Exempt" to mean products that contain lead but are compliant with EU RoHS pursuant to a specific EU RoHS exemption.

Green: TI defines "Green" to mean the content of Chlorine (Cl) and Bromine (Br) based flame retardants meet JS709B low halogen requirements of <=1000ppm threshold. Antimony trioxide based flame retardants must also meet the <=1000ppm threshold requirement.

(3) MSL, Peak Temp. - The Moisture Sensitivity Level rating according to the JEDEC industry standard classifications, and peak solder temperature.

(4) There may be additional marking, which relates to the logo, the lot trace code information, or the environmental category on the device.

(5) Multiple Device Markings will be inside parentheses. Only one Device Marking contained in parentheses and separated by a "-" will appear on a device. If a line is indented then it is a continuation of the previous line and the two combined represent the entire Device Marking for that device.

(6) Lead/Ball Finish - Orderable Devices may have multiple material finish options. Finish options are separated by a vertical ruled line. Lead/Ball Finish values may wrap to two lines if the finish value exceeds the maximum column width.

Important Information and Disclaimer:The information provided on this page represents TI's knowledge and belief as of the date that it is provided. TI bases its knowledge and belief on information provided by third parties, and makes no representation or warranty as to the accuracy of such information. Efforts are underway to better integrate information from third parties. TI has taken and continues to take reasonable steps to provide representative and accurate information but may not have conducted destructive testing or chemical analysis on incoming materials and chemicals. TI and TI suppliers consider certain information to be proprietary, and thus CAS numbers and other limited information may not be available for release.

In no event shall TI's liability arising out of such information exceed the total purchase price of the TI part(s) at issue in this document sold by TI to Customer on an annual basis.

OTHER QUALIFIED VERSIONS OF CD40175B, CD40175B-MIL :

- Catalog: [CD40175B](#)
- Military: [CD40175B-MIL](#)

NOTE: Qualified Version Definitions:

- Catalog - TI's standard catalog product
- Military - QML certified for Military and Defense Applications

TAPE AND REEL INFORMATION
REEL DIMENSIONS

TAPE DIMENSIONS

A0	Dimension designed to accommodate the component width
B0	Dimension designed to accommodate the component length
K0	Dimension designed to accommodate the component thickness
W	Overall width of the carrier tape
P1	Pitch between successive cavity centers

TAPE AND REEL INFORMATION

*All dimensions are nominal

Device	Package Type	Package Drawing	Pins	SPQ	Reel Diameter (mm)	Reel Width W1 (mm)	A0 (mm)	B0 (mm)	K0 (mm)	P1 (mm)	W (mm)	Pin1 Quadrant
CD40175BM96	SOIC	D	16	2500	330.0	16.4	6.5	10.3	2.1	8.0	16.0	Q1
CD40175BNSR	SO	NS	16	2000	330.0	16.4	8.2	10.5	2.5	12.0	16.0	Q1
CD40175BPWR	TSSOP	PW	16	2000	330.0	12.4	6.9	5.6	1.6	8.0	12.0	Q1

TAPE AND REEL BOX DIMENSIONS

*All dimensions are nominal

Device	Package Type	Package Drawing	Pins	SPQ	Length (mm)	Width (mm)	Height (mm)
CD40175BM96	SOIC	D	16	2500	333.2	345.9	28.6
CD40175BNSR	SO	NS	16	2000	367.0	367.0	38.0
CD40175BPWR	TSSOP	PW	16	2000	367.0	367.0	35.0

J (R-GDIP-T**)

14 LEADS SHOWN

CERAMIC DUAL IN-LINE PACKAGE



DIM \ PINS **	14	16	18	20
A	0.300 (7,62) BSC	0.300 (7,62) BSC	0.300 (7,62) BSC	0.300 (7,62) BSC
B MAX	0.785 (19,94)	.840 (21,34)	0.960 (24,38)	1.060 (26,92)
B MIN	—	—	—	—
C MAX	0.300 (7,62)	0.300 (7,62)	0.310 (7,87)	0.300 (7,62)
C MIN	0.245 (6,22)	0.245 (6,22)	0.220 (5,59)	0.245 (6,22)



4040083/F 03/03

- NOTES:
- All linear dimensions are in inches (millimeters).
 - This drawing is subject to change without notice.
 - This package is hermetically sealed with a ceramic lid using glass frit.
 - Index point is provided on cap for terminal identification only on press ceramic glass frit seal only.
 - Falls within MIL STD 1835 GDIP1-T14, GDIP1-T16, GDIP1-T18 and GDIP1-T20.

N (R-PDIP-T**)

PLASTIC DUAL-IN-LINE PACKAGE

16 PINS SHOWN





- NOTES:
- A. All linear dimensions are in inches (millimeters).
 - B. This drawing is subject to change without notice.
 - Falls within JEDEC MS-001, except 18 and 20 pin minimum body length (Dim A).
 - The 20 pin end lead shoulder width is a vendor option, either half or full width.

D (R-PDSO-G16)

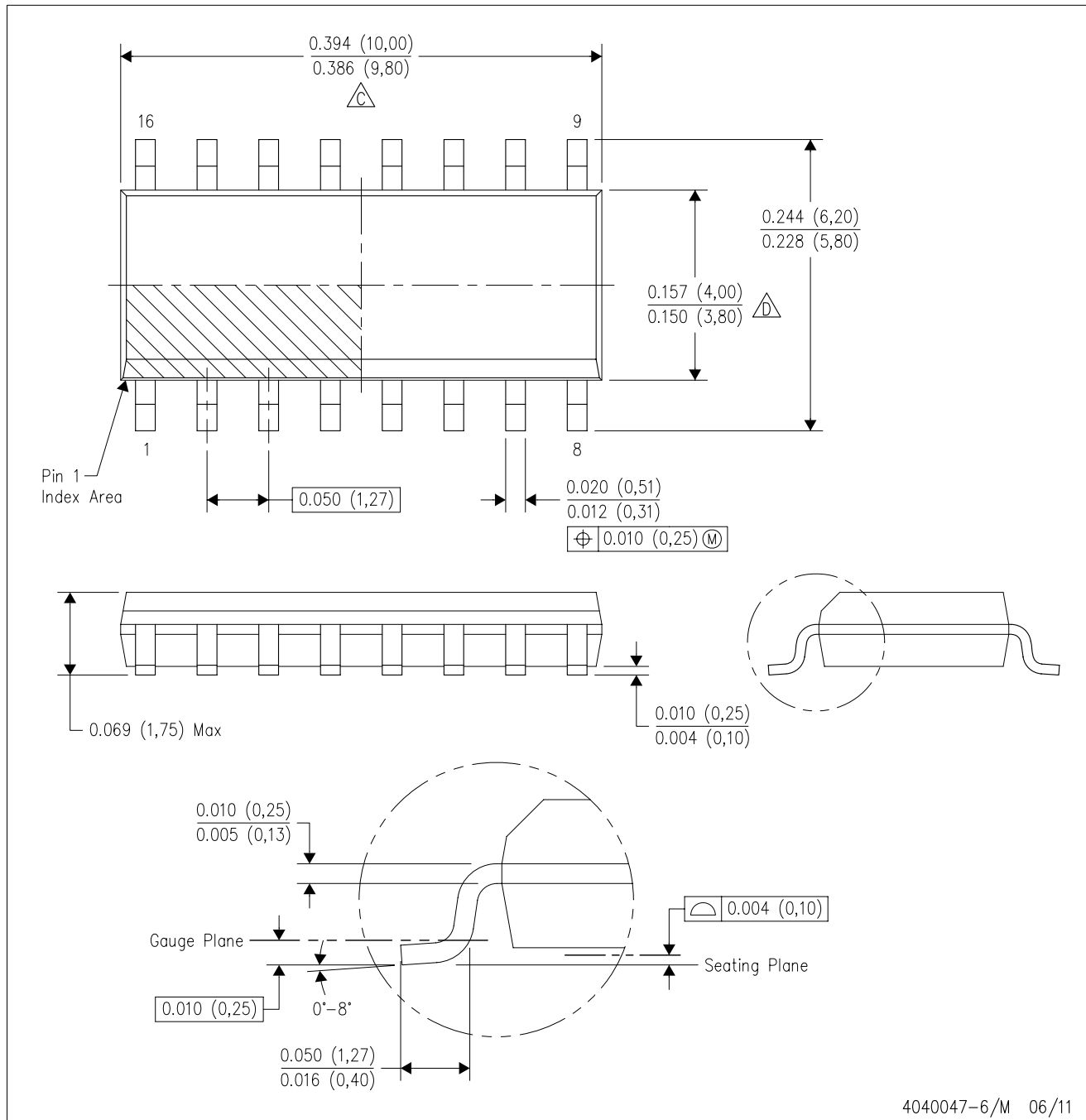
PLASTIC SMALL OUTLINE



- NOTES:
- A. All linear dimensions are in inches (millimeters).
 - B. This drawing is subject to change without notice.
 -  C. Body length does not include mold flash, protrusions, or gate burrs. Mold flash, protrusions, or gate burrs shall not exceed 0.006 (0,15) each side.
 -  D. Body width does not include interlead flash. Interlead flash shall not exceed 0.017 (0,43) each side.
 - E. Reference JEDEC MS-012 variation AC.

D (R-PDSO-G16)

PLASTIC SMALL OUTLINE



- NOTES:
- A. All linear dimensions are in millimeters.
 - B. This drawing is subject to change without notice.
 - C. Publication IPC-7351 is recommended for alternate designs.
 - D. Laser cutting apertures with trapezoidal walls and also rounding corners will offer better paste release. Customers should contact their board assembly site for stencil design recommendations. Refer to IPC-7525 for other stencil recommendations.
 - E. Customers should contact their board fabrication site for solder mask tolerances between and around signal pads.



4220204/A 02/2017

NOTES:

1. All linear dimensions are in millimeters. Any dimensions in parenthesis are for reference only. Dimensioning and tolerancing per ASME Y14.5M.
2. This drawing is subject to change without notice.
3. This dimension does not include mold flash, protrusions, or gate burrs. Mold flash, protrusions, or gate burrs shall not exceed 0.15 mm per side.
4. This dimension does not include interlead flash. Interlead flash shall not exceed 0.25 mm per side.
5. Reference JEDEC registration MO-153.

EXAMPLE BOARD LAYOUT

PW0016A

TSSOP - 1.2 mm max height

SMALL OUTLINE PACKAGE



LAND PATTERN EXAMPLE
EXPOSED METAL SHOWN
SCALE: 10X



SOLDER MASK DETAILS

4220204/A 02/2017

NOTES: (continued)

- 6. Publication IPC-7351 may have alternate designs.
- 7. Solder mask tolerances between and around signal pads can vary based on board fabrication site.

EXAMPLE STENCIL DESIGN

PW0016A

TSSOP - 1.2 mm max height

SMALL OUTLINE PACKAGE



SOLDER PASTE EXAMPLE
BASED ON 0.125 mm THICK STENCIL
SCALE: 10X

4220204/A 02/2017

NOTES: (continued)

8. Laser cutting apertures with trapezoidal walls and rounded corners may offer better paste release. IPC-7525 may have alternate design recommendations.
9. Board assembly site may have different recommendations for stencil design.

MECHANICAL DATA

NS (R-PDSO-G**)

PLASTIC SMALL-OUTLINE PACKAGE

14-PINS SHOWN



- NOTES:
- A. All linear dimensions are in millimeters.
 - B. This drawing is subject to change without notice.
 - C. Body dimensions do not include mold flash or protrusion, not to exceed 0,15.

IMPORTANT NOTICE AND DISCLAIMER

TI PROVIDES TECHNICAL AND RELIABILITY DATA (INCLUDING DATASHEETS), DESIGN RESOURCES (INCLUDING REFERENCE DESIGNS), APPLICATION OR OTHER DESIGN ADVICE, WEB TOOLS, SAFETY INFORMATION, AND OTHER RESOURCES "AS IS" AND WITH ALL FAULTS, AND DISCLAIMS ALL WARRANTIES, EXPRESS AND IMPLIED, INCLUDING WITHOUT LIMITATION ANY IMPLIED WARRANTIES OF MERCHANTABILITY, FITNESS FOR A PARTICULAR PURPOSE OR NON-INFRINGEMENT OF THIRD PARTY INTELLECTUAL PROPERTY RIGHTS.

These resources are intended for skilled developers designing with TI products. You are solely responsible for (1) selecting the appropriate TI products for your application, (2) designing, validating and testing your application, and (3) ensuring your application meets applicable standards, and any other safety, security, or other requirements. These resources are subject to change without notice. TI grants you permission to use these resources only for development of an application that uses the TI products described in the resource. Other reproduction and display of these resources is prohibited. No license is granted to any other TI intellectual property right or to any third party intellectual property right. TI disclaims responsibility for, and you will fully indemnify TI and its representatives against, any claims, damages, costs, losses, and liabilities arising out of your use of these resources.

TI's products are provided subject to TI's Terms of Sale (www.ti.com/legal/termsofsale.html) or other applicable terms available either on ti.com or provided in conjunction with such TI products. TI's provision of these resources does not expand or otherwise alter TI's applicable warranties or warranty disclaimers for TI products.

Mailing Address: Texas Instruments, Post Office Box 655303, Dallas, Texas 75265
Copyright © 2020, Texas Instruments Incorporated