

- 1. COORDINATE DIMENSION APPLIES FROM BASIC LOCATION.
- 2. 10 AND 14 POSITION SIZES CONTAIN ONLY ONE SLOT FOR SNAP-IN POLARIZER (MILITARY POLARIZATION) LOCATED AS SHOWN.
- 3. 10 POSITION SIZES CONTAIN ONLY ONE SLOT FOR DUAL POLARIZATION, LOCATED AS SHOWN.
- 4. RECOMMENDED PRINTED CIRCUIT BOARD THICKNESS IS 1.57 [.062].
- 5. DISTANCE REQUIRED BY EJECTION LATCHES IN THE OPEN POSITION.
- 6. POSTS: GOLD FLASH OVER PALLADIUM-NICKEL PLATE, 0.76µm [.000030] MIN TOTAL ON THE LOCALIZED PLATE AREA, 2.54µm [.000100] MIN TIN OR TIN-LEAD PLATE ON THE TAIL, 1.27µm [.000050] MIN NICKEL UNDERPLATE ON THE ENTIRE POST.
-OR-
0.76µm [.000030] MIN GOLD PLATE ON THE LOCALIZED PLATE AREA, 2.54µm [.000100] MIN TIN OR TIN-LEAD PLATE ON THE TAIL, 1.27µm [.000050] MIN NICKEL UNDERPLATE ON THE ENTIRE POST.
- 7. OBSOLETE PARTS: OBSOLETE CIS STREAMLINING PER D.RENAUD/D.SINISI

EJECTION LATCHES OMITTED IN THIS VIEW FOR CLARITY

RECOMMENDED PC BOARD MOUNTING DIMENSIONS SCALE 2:1

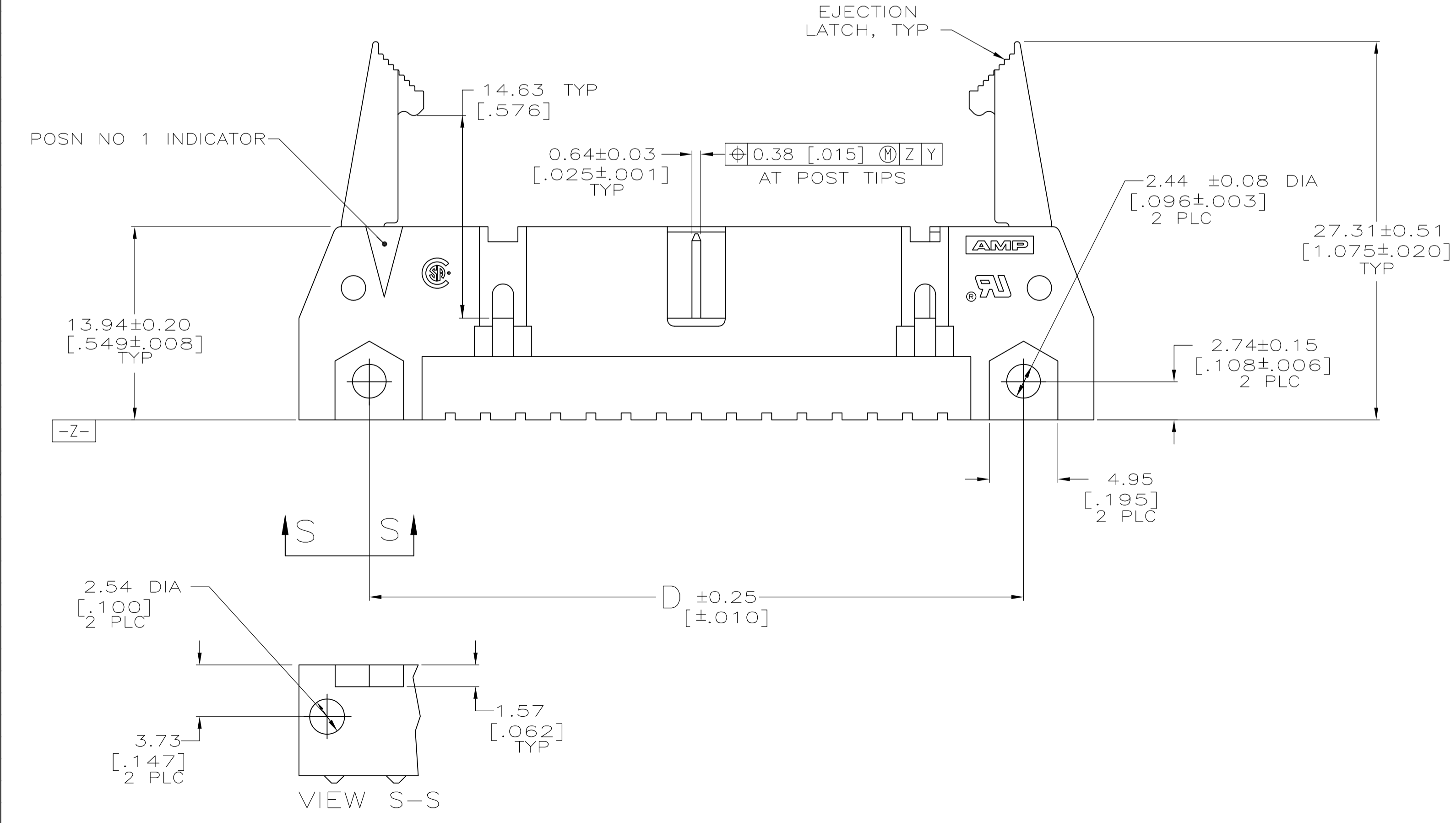
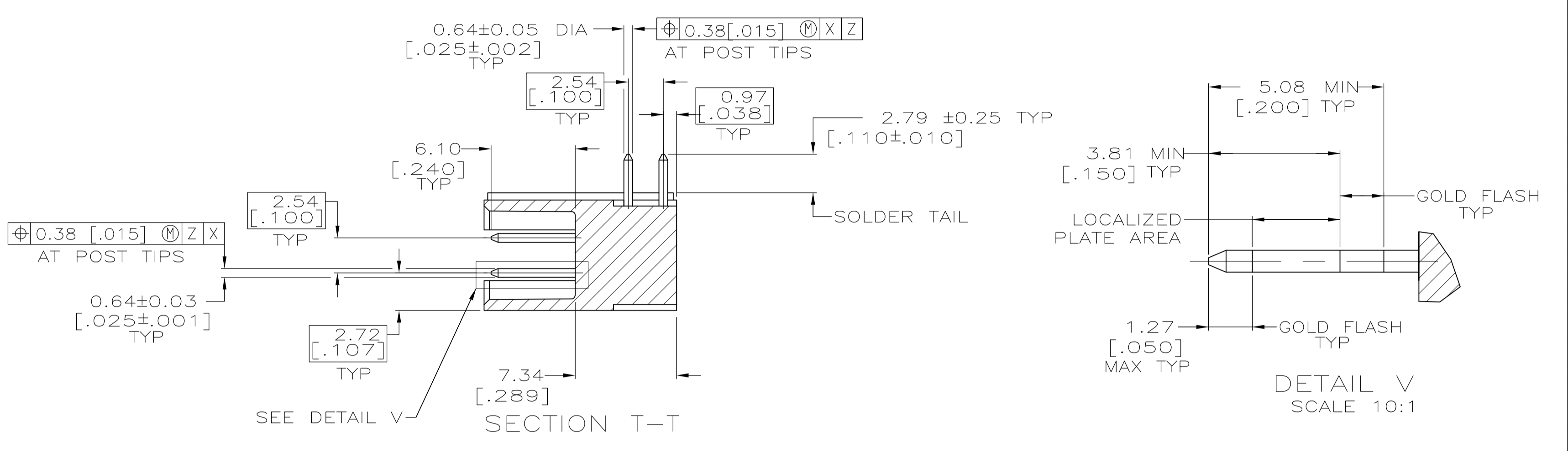
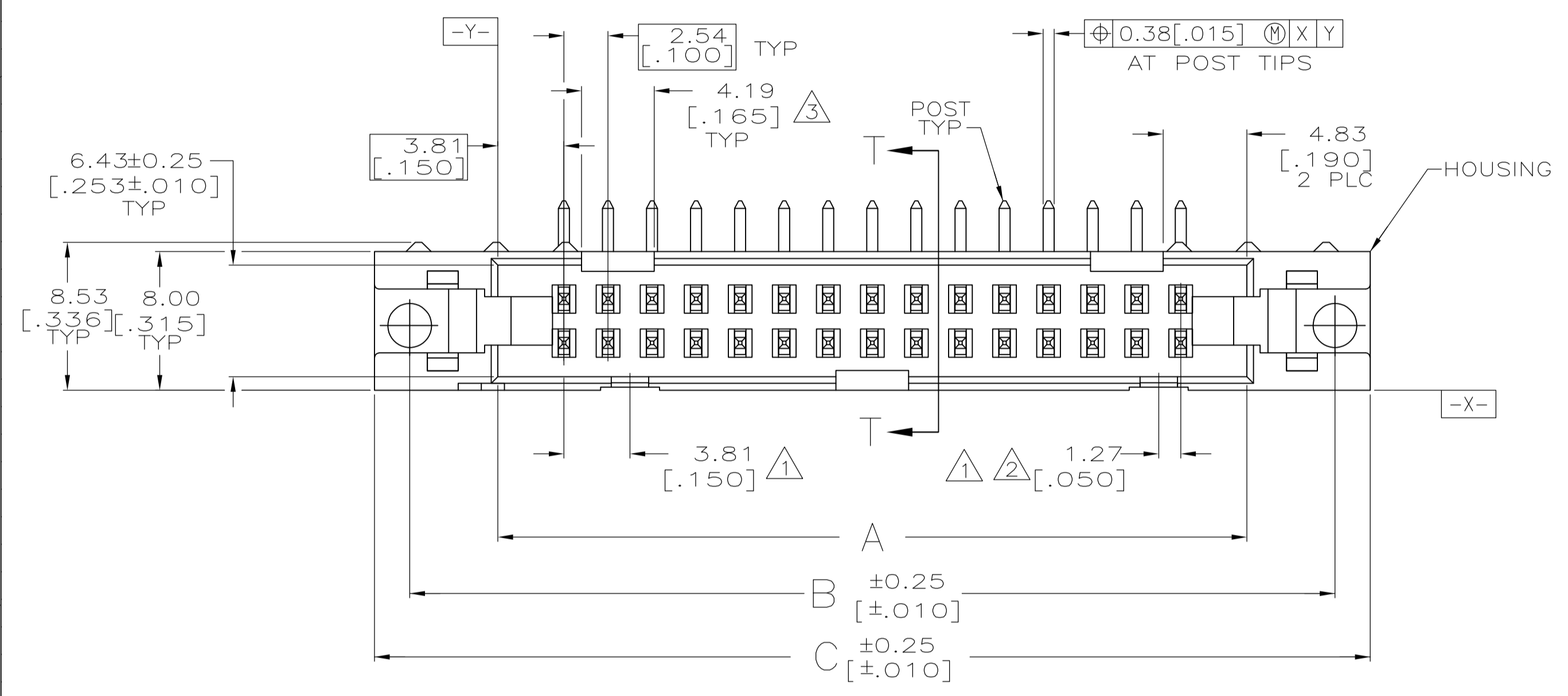

OBSOLETE	53.34	65.02	65.02	75.18	71.12	60.96	44	1-499141-3
	[2.100]	[2.560]	[2.560]	[2.960]	[2.800]	[2.400]		
7	78.74	90.42	90.42	100.58	96.52	86.36	64	1-499141-2
	[3.100]	[3.560]	[3.560]	[3.960]	[3.800]	[3.400]		
7	73.66	85.34	85.34	95.50	91.44	81.28	60	1-499141-1
	[2.900]	[3.360]	[3.360]	[3.760]	[3.600]	[3.200]		
7	60.96	72.64	72.64	82.80	78.74	68.58	50	1-499141-0
	[2.400]	[2.860]	[2.860]	[3.260]	[3.100]	[2.700]		
7	48.26	59.94	59.94	70.10	66.04	55.88	40	499141-9
	[1.900]	[2.360]	[2.360]	[2.760]	[2.600]	[2.200]		
7	40.64	52.32	52.32	62.48	58.42	48.26	34	499141-8
	[1.600]	[2.060]	[2.060]	[2.460]	[2.300]	[1.900]		
7	35.56	47.24	47.24	57.40	53.34	43.18	30	499141-7
	[1.400]	[1.860]	[1.860]	[2.260]	[2.100]	[1.700]		
7	30.48	42.16	42.16	52.32	48.26	38.10	26	499141-6
	[1.200]	[1.660]	[1.660]	[2.060]	[1.900]	[1.500]		
7	27.94	39.62	39.62	49.78	45.72	35.56	24	499141-5
	[1.100]	[1.560]	[1.560]	[1.960]	[1.800]	[1.400]		
7	22.86	34.54	34.54	44.70	40.64	30.48	20	499141-4
	[.900]	[1.360]	[1.360]	[1.760]	[1.600]	[1.200]		
7	17.78	29.46	29.46	39.62	35.56	25.40	16	499141-3
	[.700]	[1.160]	[1.160]	[1.560]	[1.400]	[1.000]		
7	15.24	26.92	26.92	37.08	33.02	22.86	14	499141-2
	[.600]	[1.060]	[1.060]	[1.460]	[1.300]	[.900]		
7	10.16	21.84	21.84	32.00	27.94	17.78	10	499141-1
	[.400]	[.860]	[.860]	[1.260]	[1.100]	[.700]		
	F	E	D	C	B	A	NO OF POSN	PART NUMBER

THIS DRAWING IS A CONTROLLED DOCUMENT.

DIMENSIONS: mm [INCHES]	TOLERANCES UNLESS OTHERWISE SPECIFIED:	DIN H. MOLL 4-23-90	STE TE Connectivity
0 PLC ± -	1 PLC ± -	11-28-90	R. STONE
2 PLC ± ± 0.13 [.005]	3 PLC ± ± -	11-29-90	S. GOOD
4 PLC ± ± -	ANGLES ± ± -	NAME	HEADER ASSY, UNIVERSAL, AMP-LATCH
MATERIAL: HOUSING & LATCHES: GLASS FILLED NYLON OR POLYESTER, 90-10 AIBD. BLACK POSTS: BRASS	FINISH: 6	PRODUCT SPEC: 108-40018	APPLICATION SPEC: -
WEIGHT: -	SIZE: A1	CAGE CODE: 00779	DRAWING NO: 499141
CUSTOMER DRAWING	SCALE: 4:1	SHEET: 1 OF 1	REV: K2

Mouser Electronics

Authorized Distributor

Click to View Pricing, Inventory, Delivery & Lifecycle Information:

[TE Connectivity:](#)

[499141-8](#)