

## Important notice

Dear Customer,

On 7 February 2017 the former NXP Standard Product business became a new company with the tradename **Nexperia**. Nexperia is an industry leading supplier of Discrete, Logic and PowerMOS semiconductors with its focus on the automotive, industrial, computing, consumer and wearable application markets

In data sheets and application notes which still contain NXP or Philips Semiconductors references, use the references to Nexperia, as shown below.

Instead of <http://www.nxp.com>, <http://www.philips.com/> or <http://www.semiconductors.philips.com/>, use <http://www.nexperia.com>

Instead of [sales.addresses@www.nxp.com](mailto:sales.addresses@www.nxp.com) or [sales.addresses@www.semiconductors.philips.com](mailto:sales.addresses@www.semiconductors.philips.com), use [salesaddresses@nexperia.com](mailto:salesaddresses@nexperia.com) (email)

Replace the copyright notice at the bottom of each page or elsewhere in the document, depending on the version, as shown below:

- © NXP N.V. (year). All rights reserved or © Koninklijke Philips Electronics N.V. (year). All rights reserved

Should be replaced with:

- © **Nexperia B.V. (year). All rights reserved.**

If you have any questions related to the data sheet, please contact our nearest sales office via e-mail or telephone (details via [salesaddresses@nexperia.com](mailto:salesaddresses@nexperia.com)). Thank you for your cooperation and understanding,

Kind regards,

Team Nexperia

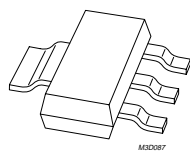

# PHT4NQ10T

TrenchMOS™ standard level FET

Rev. 02 — 2 May 2002

Product data

## 1. Description

N-channel enhancement mode field-effect transistor in a plastic package using TrenchMOS™ technology.

Product availability:

PHT4NQ10T in SOT223.

## 2. Features

- TrenchMOS™ technology
- Very fast switching
- Surface mount package.

## 3. Applications

- Primary side switch in DC to DC converters
- High speed line driver
- Fast general purpose switch.

## 4. Pinning information

Table 1: Pinning - SOT223, simplified outline and symbol

Pin	Description	Simplified outline	Symbol
1	gate (g)	<p style="text-align: center;"><b>SOT223</b></p>	
2	drain (d)		
3	source (g)		
4	drain (d)		

## 5. Quick reference data

**Table 2: Quick reference data**

Symbol	Parameter	Conditions	Typ	Max	Unit
$V_{DS}$	drain-source voltage (DC)	$25\text{ °C} \leq T_j \leq 150\text{ °C}$	-	100	V
$I_D$	drain current (DC)	$T_{sp} = 25\text{ °C}; V_{GS} = 10\text{ V}$	-	3.5	A
$P_{tot}$	total power dissipation	$T_{sp} = 25\text{ °C}$	-	6.9	W
$T_j$	junction temperature		-	150	°C
$R_{DS(on)}$	drain-source on-state resistance	$V_{GS} = 10\text{ V}; I_D = 1.75\text{ A}$			
		$T_j = 25\text{ °C}$	200	250	mΩ
		$T_j = 150\text{ °C}$	-	575	mΩ

## 6. Limiting values

**Table 3: Limiting values**

In accordance with the Absolute Maximum Rating System (IEC 60134).

Symbol	Parameter	Conditions	Min	Max	Unit
$V_{DS}$	drain-source voltage (DC)	$25\text{ °C} \leq T_j \leq 150\text{ °C}$	-	100	V
$V_{DGR}$	drain-gate voltage (DC)	$25\text{ °C} \leq T_j \leq 150\text{ °C}; R_{GS} = 20\text{ k}\Omega$	-	100	V
$V_{GS}$	gate-source voltage (DC)		-	±20	V
$I_D$	drain current (DC)	$T_{sp} = 25\text{ °C}; V_{GS} = 10\text{ V};$ Figure 2 and 3	-	3.5	A
		$T_{sp} = 100\text{ °C}; V_{GS} = 10\text{ V};$ Figure 2	-	2.2	A
$I_{DM}$	peak drain current	$T_{sp} = 25\text{ °C};$ pulsed; $t_p \leq 10\text{ }\mu\text{s};$ Figure 3	-	14	A
$P_{tot}$	total power dissipation	$T_{sp} = 25\text{ °C};$ Figure 1	-	6.9	W
$T_{stg}$	storage temperature		-65	+150	°C
$T_j$	junction temperature		-65	+150	°C

### Source-drain diode

$I_S$	source (diode forward) current (DC)	$T_{sp} = 25\text{ °C}$	-	3.5	A
$I_{SM}$	peak source (diode forward) current	$T_{sp} = 25\text{ °C};$ pulsed; $t_p \leq 10\text{ }\mu\text{s}$	-	14	A

### Avalanche ruggedness

$E_{DS(AL)S}$	non-repetitive drain-source avalanche energy	unclamped inductive load; $I_D = 3.5\text{ A};$ $t_p = 0.2\text{ ms}; V_{DD} \leq 15\text{ V}; R_{GS} = 50\text{ }\Omega;$	-	45	mJ
$I_{DS(AL)SM}$	peak non-repetitive drain-source avalanche current	$V_{GS} = 10\text{ V};$ starting $T_j = 25\text{ °C};$ Figure 4	-	3.5	A

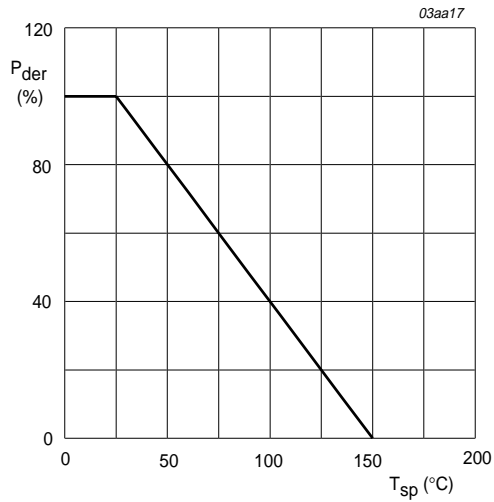

$$P_{der} = \frac{P_{tot}}{P_{tot(25^{\circ}C)}} \times 100\%$$

**Fig 1. Normalized total power dissipation as a function of solder point temperature.**

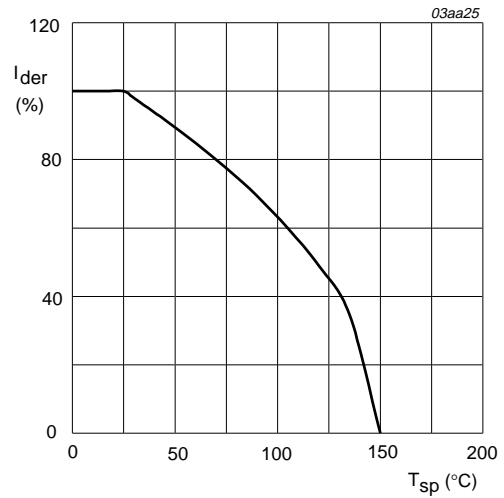

$$V_{GS} \geq 10 \text{ V}$$

$$I_{der} = \frac{I_D}{I_{D(25^{\circ}C)}} \times 100\%$$

**Fig 2. Normalized continuous drain current as a function of solder point temperature.**

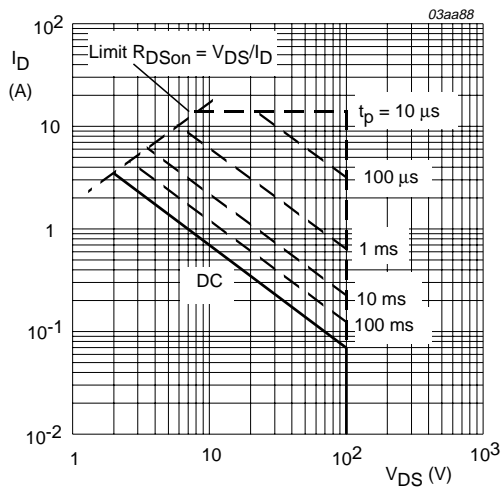

$T_{sp} = 25^{\circ}C$ ;  $I_{DM}$  is single pulse.

**Fig 3. Safe operating area; continuous and peak drain currents as a function of drain-source voltage.**

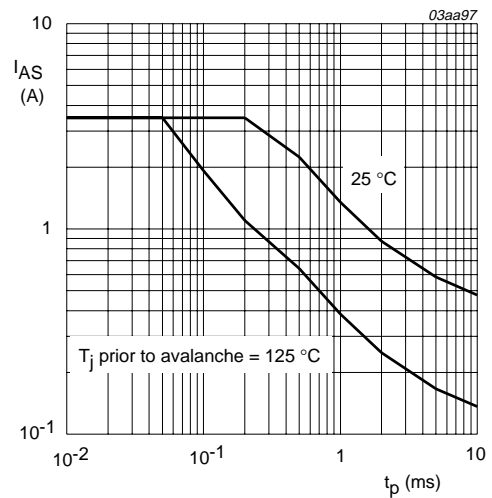

Unclamped inductive load;  $V_{DD} \leq 15 \text{ V}$ ;  $R_{GS} = 50 \Omega$ ;  $V_{GS} = 10 \text{ V}$ ; starting  $T_j = 25^{\circ}C$  and  $125^{\circ}C$ .

**Fig 4. Non-repetitive avalanche ruggedness current as a function of pulse duration.**

## 7. Thermal characteristics

Table 4: Thermal characteristics

Symbol	Parameter	Conditions	Min	Typ	Max	Unit
$R_{th(j-sp)}$	thermal resistance from junction to solder point	mounted on a metal clad substrate; <b>Figure 5</b>	-	-	18	K/W
$R_{th(j-a)}$	thermal resistance from junction to ambient	mounted on a printed circuit board; minimum footprint	-	150	-	K/W

### 7.1 Transient thermal impedance

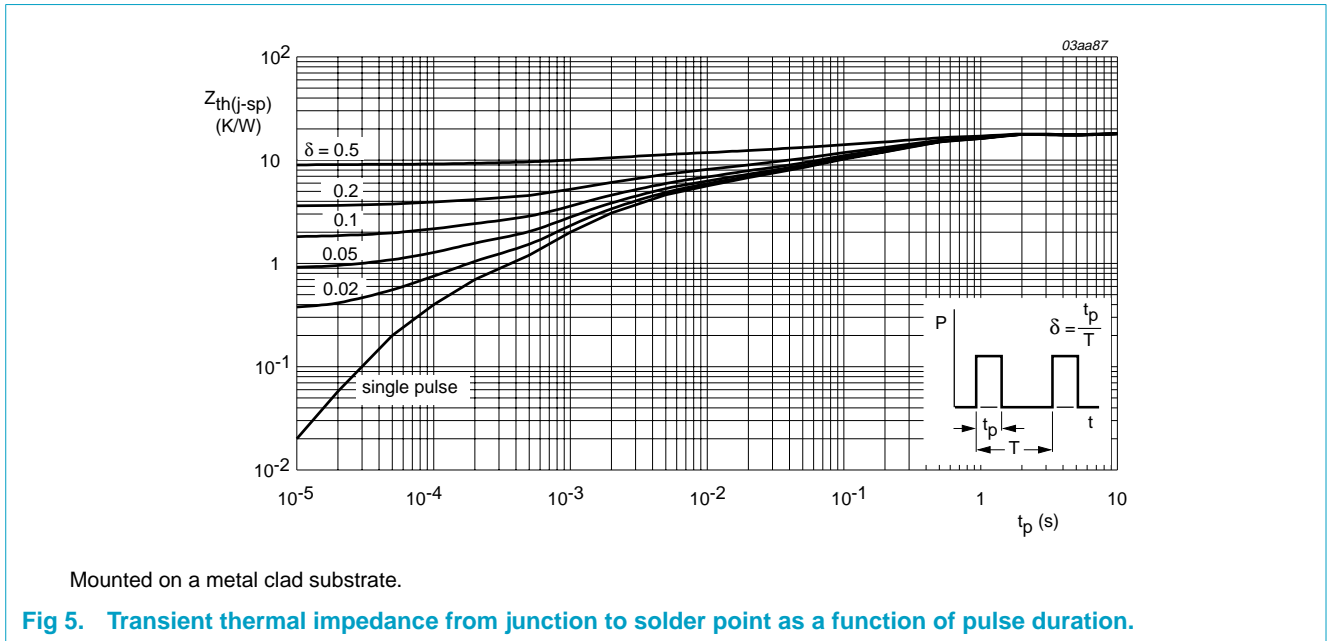

## 8. Characteristics

**Table 5: Characteristics**
 $T_j = 25\text{ °C}$  unless otherwise specified

Symbol	Parameter	Conditions	Min	Typ	Max	Unit
<b>Static characteristics</b>						
$V_{(BR)DSS}$	drain-source breakdown voltage	$I_D = 250\ \mu\text{A}; V_{GS} = 0\ \text{V}$				
		$T_j = 25\text{ °C}$	100	130	-	V
		$T_j = -55\text{ °C}$	89	-	-	V
$V_{GS(th)}$	gate-source threshold voltage	$I_D = 1\ \text{mA}; V_{DS} = V_{GS}$				
		$T_j = 25\text{ °C};$ <b>Figure 10</b>	2	3	4	V
		$T_j = 150\text{ °C};$ <b>Figure 10</b>	1.2	-	-	V
		$T_j = -55\text{ °C};$ <b>Figure 10</b>	-	-	6	V
$I_{DSS}$	drain-source leakage current	$V_{DS} = 100\ \text{V}; V_{GS} = 0\ \text{V}$				
		$T_j = 25\text{ °C}$	-	1	25	$\mu\text{A}$
		$T_j = 150\text{ °C}$	-	4	250	$\mu\text{A}$
		$V_{DS} = 60\ \text{V}; V_{GS} = 0\ \text{V}$				
		$T_j = 85\text{ °C}$	-	-	1	$\mu\text{A}$
$I_{GSS}$	gate-source leakage current	$V_{GS} = \pm 20\ \text{V}; V_{DS} = 0\ \text{V}$	-	10	100	nA
$R_{DS(on)}$	drain-source on-state resistance	$V_{GS} = 10\ \text{V}; I_D = 1.75\ \text{A}$				
		$T_j = 25\text{ °C};$ <b>Figure 8 and 9</b>	-	200	250	m $\Omega$
		$T_j = 150\text{ °C};$ <b>Figure 9</b>	-	-	575	m $\Omega$
<b>Dynamic characteristics</b>						
$g_{fs}$	forward transconductance	$V_{DS} = 5\ \text{V}; I_D = 3.5\ \text{A};$ <b>Figure 12</b>	-	4.2		S
$Q_{g(tot)}$	total gate charge	$I_D = 3.5\ \text{A}; V_{DS} = 80\ \text{V};$ $V_{GS} = 10\ \text{V};$ <b>Figure 15</b>	-	7.4	-	nC
$Q_{gs}$	gate-source charge		-	1.5	-	nC
$Q_{gd}$	gate-drain (Miller) charge		-	3.3	-	nC
$C_{iss}$	input capacitance	$V_{GS} = 0\ \text{V}; V_{DS} = 25\ \text{V};$ $f = 1\ \text{MHz};$ <b>Figure 13</b>	-	300	-	pF
$C_{oss}$	output capacitance		-	44	-	pF
$C_{rss}$	reverse transfer capacitance		-	21	-	pF
$t_{d(on)}$	turn-on delay time	$V_{DD} = 50\ \text{V}; R_D = 15\ \Omega;$ $V_{GS} = 10\ \text{V}; R_G = 6\ \Omega$	-	8	-	ns
$t_r$	rise time		-	13	-	ns
$t_{d(off)}$	turn-off delay time		-	20	-	ns
$t_f$	fall time		-	11	-	ns
<b>Source-drain diode</b>						
$V_{SD}$	source-drain (diode forward) voltage	$I_S = 3.5\ \text{A}; V_{GS} = 0\ \text{V};$ <b>Figure 14</b>	-	0.87	1.5	V
$t_{rr}$	reverse recovery time	$I_S = 3.5\ \text{A};$ $di_S/dt = -100\ \text{A}/\mu\text{s};$ $V_{GS} = 0\ \text{V}; V_{DS} = 30\ \text{V}$	-	50	-	ns
$Q_r$	recovered charge		-	100	-	nC

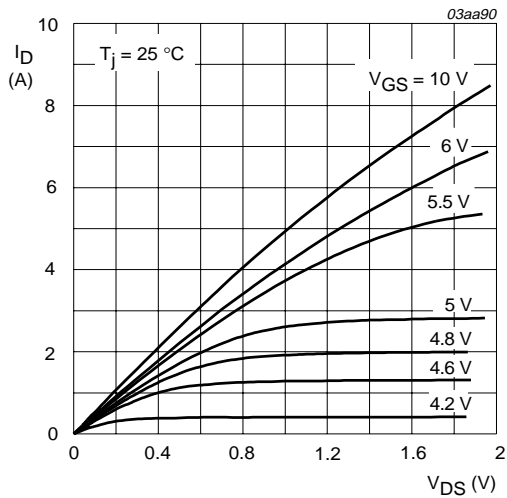

$T_j = 25\text{ °C}$

Fig 6. Output characteristics: drain current as a function of drain-source voltage; typical values.

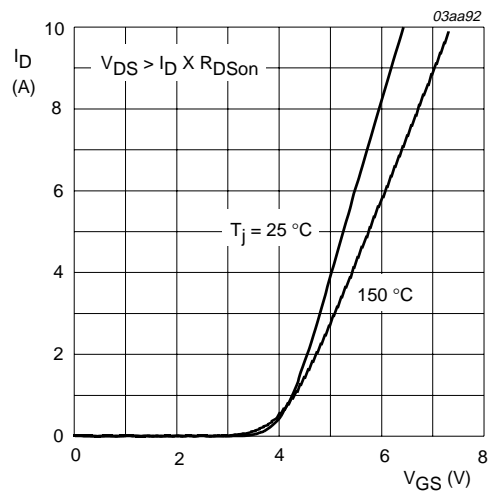

$T_j = 25\text{ °C}$  and  $150\text{ °C}$ ;  $V_{DS} > I_D \times R_{DSon}$

Fig 7. Transfer characteristics: drain current as a function of gate-source voltage; typical values.

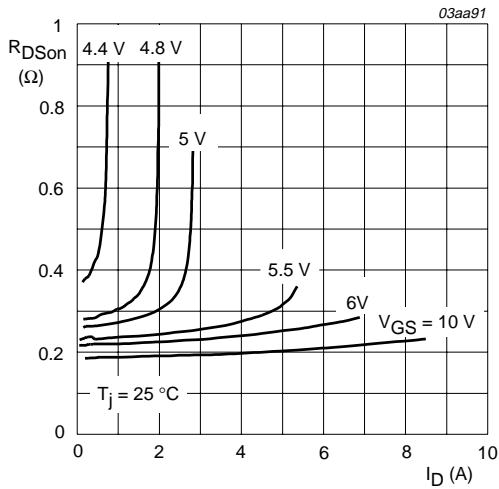

$T_j = 25\text{ °C}$

Fig 8. Drain-source on-state resistance as a function of drain current; typical values.

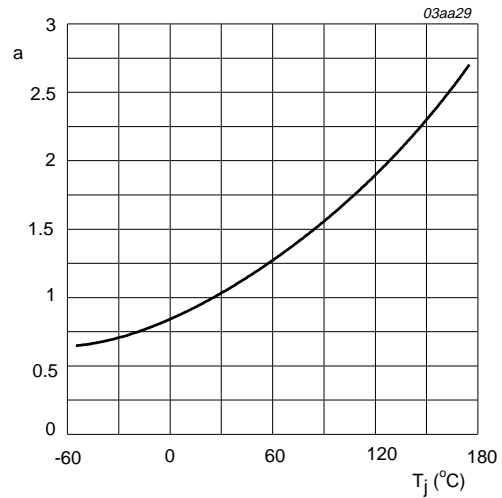

$$a = \frac{R_{DSon}}{R_{DSon(25\text{ °C})}}$$

Fig 9. Normalized drain-source on-state resistance factor as a function of junction temperature.

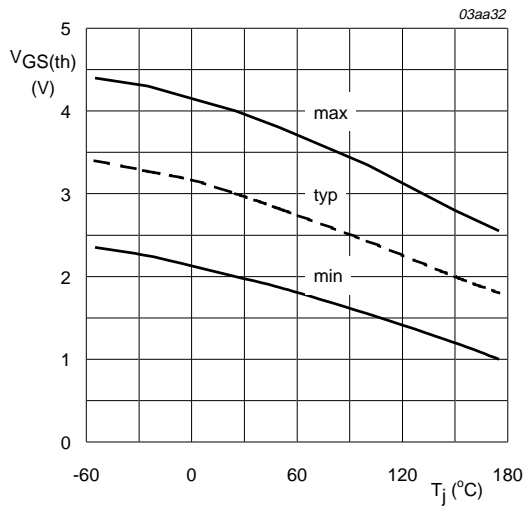

$I_D = 1 \text{ mA}; V_{DS} = V_{GS}$

**Fig 10. Gate-source threshold voltage as a function of junction temperature.**

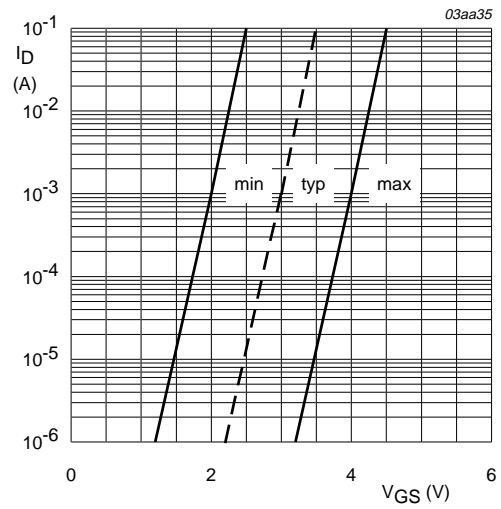

$T_j = 25 \text{ }^{\circ}C; V_{DS} = 5 \text{ V}$

**Fig 11. Sub-threshold drain current as a function of gate-source voltage.**

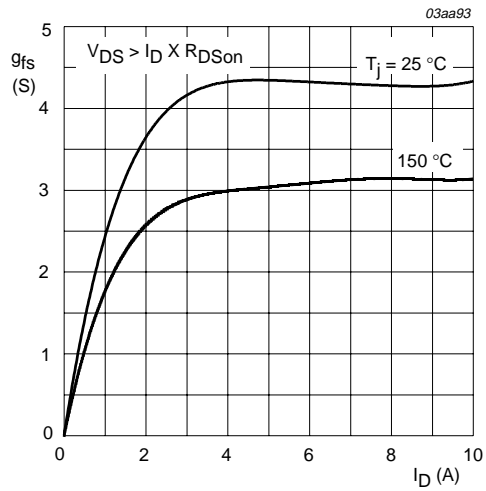

$T_j = 25 \text{ }^{\circ}C \text{ and } 150 \text{ }^{\circ}C; V_{DS} > I_D \times R_{DSon}$

**Fig 12. Forward transconductance as a function of drain current; typical values.**

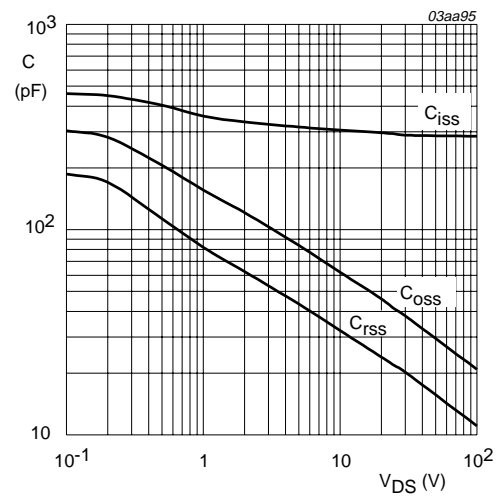

$V_{GS} = 0 \text{ V}; f = 1 \text{ MHz}$

**Fig 13. Input, output and reverse transfer capacitances as a function of drain-source voltage; typical values.**



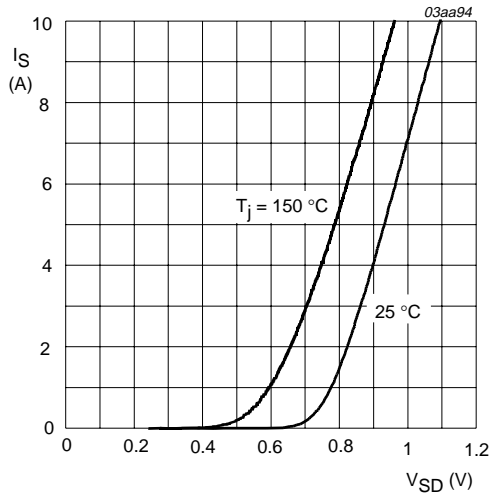

$T_j = 25^\circ\text{C}$  and  $150^\circ\text{C}$ ;  $V_{GS} = 0$  V

**Fig 14. Source (diode forward) current as a function of source-drain (diode forward) voltage; typical values.**

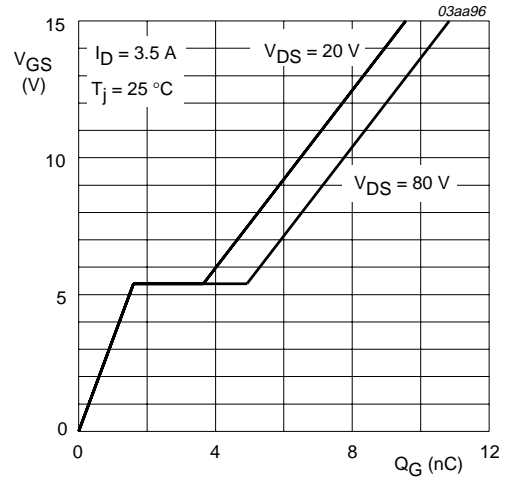

$I_D = 3.5$  A;  $V_{DS} = 80$  V

**Fig 15. Gate-source voltage as a function of gate charge; typical values.**

9. Package outline

Plastic surface mounted package; collector pad for good heat transfer; 4 leads

SOT223

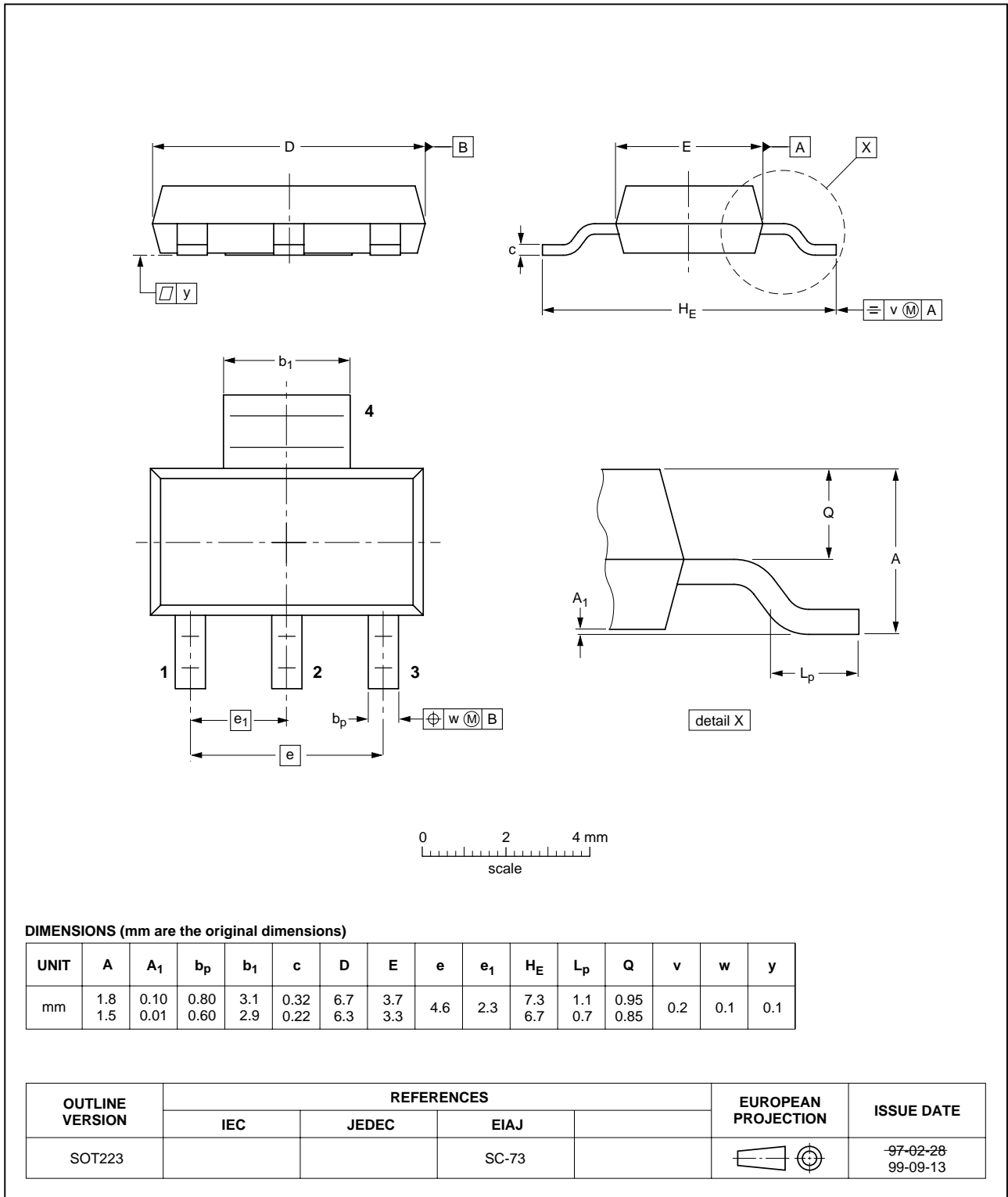

Fig 16. SOT223.

## 10. Revision history

Table 6: Revision history

Rev	Date	CPCN	Description
02	20020502	-	<b>Product data (9397 750 09581)</b> Modifications: <ul style="list-style-type: none"><li>• Additional <math>I_{DSS}</math> data added.</li></ul>
01	20000731	-	<b>Product specification; initial version.</b>

## 11. Data sheet status

Data sheet status <sup>[1]</sup>	Product status <sup>[2]</sup>	Definition
Objective data	Development	This data sheet contains data from the objective specification for product development. Philips Semiconductors reserves the right to change the specification in any manner without notice.
Preliminary data	Qualification	This data sheet contains data from the preliminary specification. Supplementary data will be published at a later date. Philips Semiconductors reserves the right to change the specification without notice, in order to improve the design and supply the best possible product.
Product data	Production	This data sheet contains data from the product specification. Philips Semiconductors reserves the right to make changes at any time in order to improve the design, manufacturing and supply. Changes will be communicated according to the Customer Product/Process Change Notification (CPCN) procedure SNW-SQ-650A.

[1] Please consult the most recently issued data sheet before initiating or completing a design.

[2] The product status of the device(s) described in this data sheet may have changed since this data sheet was published. The latest information is available on the Internet at URL <http://www.semiconductors.philips.com>.

## 12. Definitions

**Short-form specification** — The data in a short-form specification is extracted from a full data sheet with the same type number and title. For detailed information see the relevant data sheet or data handbook.

**Limiting values definition** — Limiting values given are in accordance with the Absolute Maximum Rating System (IEC 60134). Stress above one or more of the limiting values may cause permanent damage to the device. These are stress ratings only and operation of the device at these or at any other conditions above those given in the Characteristics sections of the specification is not implied. Exposure to limiting values for extended periods may affect device reliability.

**Application information** — Applications that are described herein for any of these products are for illustrative purposes only. Philips Semiconductors make no representation or warranty that such applications will be suitable for the specified use without further testing or modification.

## 13. Disclaimers

**Life support** — These products are not designed for use in life support appliances, devices, or systems where malfunction of these products can reasonably be expected to result in personal injury. Philips Semiconductors customers using or selling these products for use in such applications do so at their own risk and agree to fully indemnify Philips Semiconductors for any damages resulting from such application.

**Right to make changes** — Philips Semiconductors reserves the right to make changes, without notice, in the products, including circuits, standard cells, and/or software, described or contained herein in order to improve design and/or performance. Philips Semiconductors assumes no responsibility or liability for the use of any of these products, conveys no licence or title under any patent, copyright, or mask work right to these products, and makes no representations or warranties that these products are free from patent, copyright, or mask work right infringement, unless otherwise specified.

## 14. Trademarks

**TrenchMOS** — is a trademark of Koninklijke Philips Electronics N.V.

## Contact information

For additional information, please visit <http://www.semiconductors.philips.com>.

For sales office addresses, send e-mail to: [sales.addresses@www.semiconductors.philips.com](mailto:sales.addresses@www.semiconductors.philips.com).

Fax: +31 40 27 24825

## Contents

1	Description . . . . .	1
2	Features . . . . .	1
3	Applications . . . . .	1
4	Pinning information . . . . .	1
5	Quick reference data . . . . .	2
6	Limiting values . . . . .	2
7	Thermal characteristics . . . . .	4
7.1	Transient thermal impedance . . . . .	4
8	Characteristics . . . . .	5
9	Package outline . . . . .	9
10	Revision history . . . . .	10
11	Data sheet status . . . . .	11
12	Definitions . . . . .	11
13	Disclaimers . . . . .	11
14	Trademarks . . . . .	11

© Koninklijke Philips Electronics N.V. 2002.  
Printed in The Netherlands

All rights are reserved. Reproduction in whole or in part is prohibited without the prior written consent of the copyright owner.

The information presented in this document does not form part of any quotation or contract, is believed to be accurate and reliable and may be changed without notice. No liability will be accepted by the publisher for any consequence of its use. Publication thereof does not convey nor imply any license under patent- or other industrial or intellectual property rights.

Date of release: 2 May 2002

Document order number: 9397 750 09581



# PHILIPS

*Let's make things better.*