



STW26NM60

N-CHANNEL 600V - 0.125Ω - 26A TO-247 Zener-Protected MDmesh™ Power MOSFET

TYPE	V _{DSS}	R _{DS(on)}	I _D
STW26NM60	600 V	< 0.135 Ω	30 A

- TYPICAL R_{DS(on)} = 0.125Ω
- HIGH dv/dt AND AVALANCHE CAPABILITIES
- IMPROVED ESD CAPABILITY
- LOW INPUT CAPACITANCE AND GATE CHARGE
- LOW GATE INPUT RESISTANCE

DESCRIPTION

The MDmesh™ is a new revolutionary MOSFET technology that associates the Multiple Drain process with the Company's PowerMESH™ horizontal layout. The resulting product has an outstanding low on-resistance, impressively high dv/dt and excellent avalanche characteristics. The adoption of the Company's proprietary strip technique yields overall dynamic performance that is significantly better than that of similar competition's products.

APPLICATIONS

The MDmesh™ family is very suitable for increasing power density of high voltage converters allowing system miniaturization and higher efficiencies.

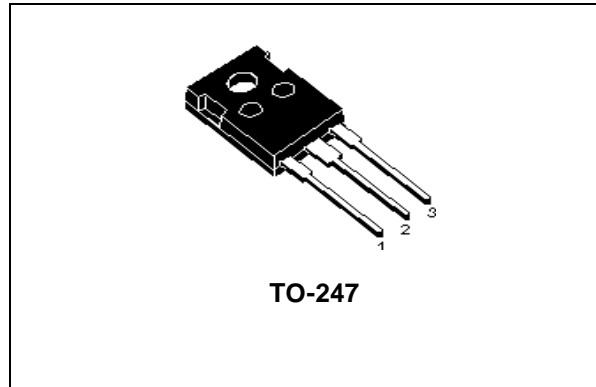

INTERNAL SCHEMATIC DIAGRAM

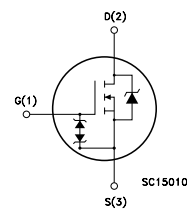

ORDERING INFORMATION

SALES TYPE	MARKING	PACKAGE	PACKAGING
STW26NM60	W26NM60	TO-247	TUBE

STW26NM60

ABSOLUTE MAXIMUM RATINGS

Symbol	Parameter	Value	Unit
V _{DS}	Drain-source Voltage (V _{GS} = 0)	600	V
V _{DGR}	Drain-gate Voltage (R _{GS} = 20 kΩ)	600	V
V _{GS}	Gate- source Voltage	± 30	V
I _D	Drain Current (continuous) at T _C = 25°C	30	A
I _D	Drain Current (continuous) at T _C = 100°C	18.9	A
I _{DM} (•)	Drain Current (pulsed)	120	A
P _{TOT}	Total Dissipation at T _C = 25°C	313	W
	Derating Factor	2.5	W/°C
V _{ESD(G-S)}	Gate source ESD(HBM-C=100pF, R=1.5KΩ)	6000	V
dv/dt (1)	Peak Diode Recovery voltage slope	15	V/ns
T _j T _{stg}	Operating Junction Temperature Storage Temperature	-55 to 150	°C

(•) Pulse width limited by safe operating area

(1) I_{SD} ≤ 26A, di/dt ≤ 200A/μs, V_{DD} ≤ V_{(BR)DSS}, T_j ≤ T_{JMAX}.

THERMAL DATA

R _{thj-case}	Thermal Resistance Junction-case Max	0.4	°C/W
R _{thj-amb}	Thermal Resistance Junction-ambient Max	62.5	°C/W
T _I	Maximum Lead Temperature For Soldering Purpose	300	°C

AVALANCHE CHARACTERISTICS

Symbol	Parameter	Max Value	Unit
I _{AR}	Avalanche Current, Repetitive or Not-Repetitive (pulse width limited by T _j max)	13	A
E _{AS}	Single Pulse Avalanche Energy (starting T _j = 25 °C, I _D = I _{AR} , V _{DD} = 50 V)	740	mJ

GATE-SOURCE ZENER DIODE

Symbol	Parameter	Test Conditions	Min.	Typ.	Max.	Unit
BV _{GSO}	Gate-Source Breakdown Voltage	I _{gss} =± 1mA (Open Drain)	30			V

PROTECTION FEATURES OF GATE-TO-SOURCE ZENER DIODES

The built-in back-to-back Zener diodes have specifically been designed to enhance not only the device's ESD capability, but also to make them safely absorb possible voltage transients that may occasionally be applied from gate to source. In this respect the Zener voltage is appropriate to achieve an efficient and cost-effective intervention to protect the device's integrity. These integrated Zener diodes thus avoid the usage of external components.

ELECTRICAL CHARACTERISTICS ($T_{CASE} = 25^{\circ}C$ UNLESS OTHERWISE SPECIFIED)
 ON/OFF

Symbol	Parameter	Test Conditions	Min.	Typ.	Max.	Unit
$V_{(BR)DSS}$	Drain-source Breakdown Voltage	$I_D = 250 \mu A, V_{GS} = 0$	600			V
I_{DSS}	Zero Gate Voltage Drain Current ($V_{GS} = 0$)	$V_{DS} = \text{Max Rating}$ $V_{DS} = \text{Max Rating}, T_C = 125^{\circ}C$			10 100	μA μA
I_{GSS}	Gate-body Leakage Current ($V_{DS} = 0$)	$V_{GS} = \pm 20V$			± 10	μA
$V_{GS(th)}$	Gate Threshold Voltage	$V_{DS} = V_{GS}, I_D = 250\mu A$	3	4	5	V
$R_{DS(on)}$	Static Drain-source On Resistance	$V_{GS} = 10V, I_D = 13 A$		0.125	0.135	Ω

DYNAMIC

Symbol	Parameter	Test Conditions	Min.	Typ.	Max.	Unit
$g_{fs} (1)$	Forward Transconductance	$V_{DS} = 15 V, I_D = 13 A$		20		S
C_{iss} C_{oss} C_{rss}	Input Capacitance Output Capacitance Reverse Transfer Capacitance	$V_{DS} = 25V, f = 1 \text{ MHz}, V_{GS} = 0$		2900 900 40		pF pF pF

SWITCHING ON

Symbol	Parameter	Test Conditions	Min.	Typ.	Max.	Unit
$t_{d(on)}$ t_r	Turn-on Delay Time Rise Time	$V_{DD} = 300V, I_D = 13 A$ $R_G = 4.7\Omega, V_{GS} = 10 V$ (Resistive Load see, Figure 3)		35 22		ns ns
Q_g Q_{gs} Q_{gd}	Total Gate Charge Gate-Source Charge Gate-Drain Charge	$V_{DD} = 480V, I_D = 26 A,$ $V_{GS} = 10V$		73 20 37	102	nC nC nC

SWITCHING OFF

Symbol	Parameter	Test Conditions	Min.	Typ.	Max.	Unit
$t_r(V_{off})$ t_f t_c	Off-voltage Rise Time Fall Time Cross-over Time	$V_{DD} = 480V, I_D = 26 A,$ $R_G = 4.7\Omega, V_{GS} = 10V$ (Inductive Load see, Figure 5)		14 20 40		ns ns ns

SOURCE DRAIN DIODE

Symbol	Parameter	Test Conditions	Min.	Typ.	Max.	Unit
I_{SD} $I_{SDM} (2)$	Source-drain Current Source-drain Current (pulsed)				26 104	A A
$V_{SD} (1)$	Forward On Voltage	$I_{SD} = 26 A, V_{GS} = 0$			1.5	V
t_{rr} Q_{rr} I_{RRM}	Reverse Recovery Time Reverse Recovery Charge Reverse Recovery Current	$I_{SD} = 26 A, di/dt = 100A/\mu s$ $V_{DD} = 100 V, T_j = 25^{\circ}C$ (see test circuit, Figure 5)		450 7 30.5		ns μC A
t_{rr} Q_{rr} I_{RRM}	Reverse Recovery Time Reverse Recovery Charge Reverse Recovery Current	$I_{SD} = 26 A, di/dt = 100A/\mu s$ $V_{DD} = 100 V, T_j = 150^{\circ}C$ (see test circuit, Figure 5)		560 9 32.5		ns μC A

Note: 1. Pulsed: Pulse duration = 300 μs , duty cycle 1.5 %.
 2. Pulse width limited by safe operating area.

Safe Operating Area For TO-247

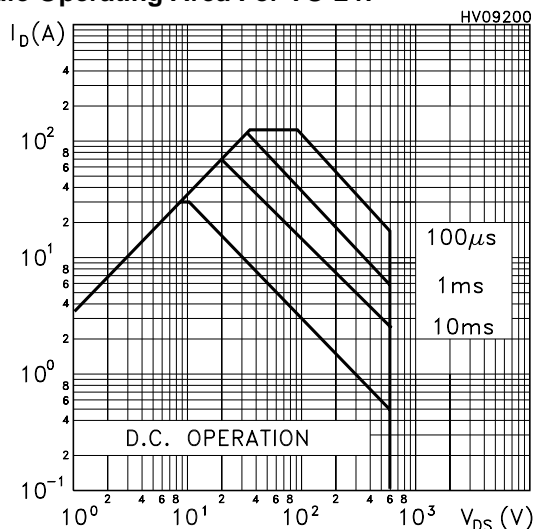

Thermal Impedance For TO-247

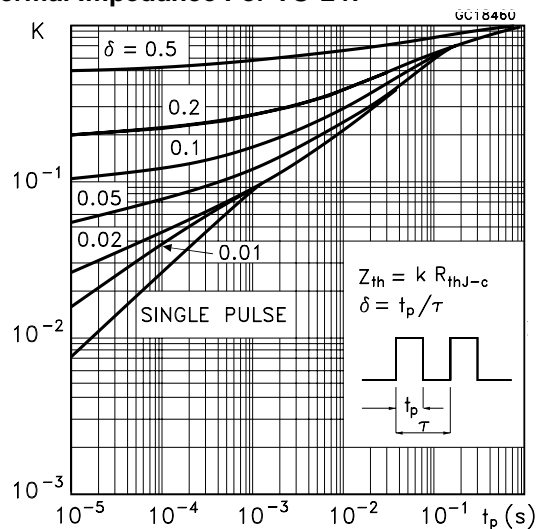

Output Characteristics

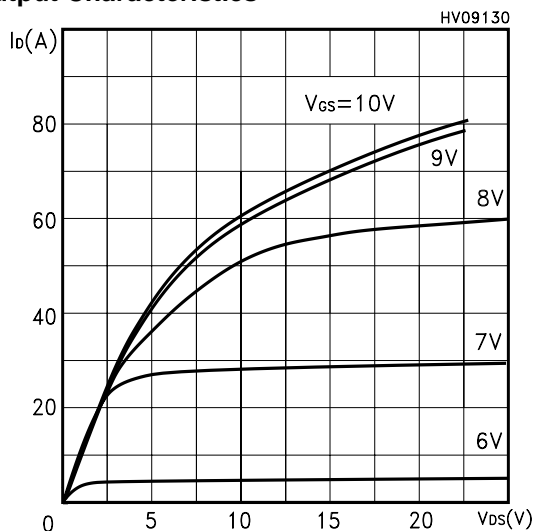

Transfer Characteristics

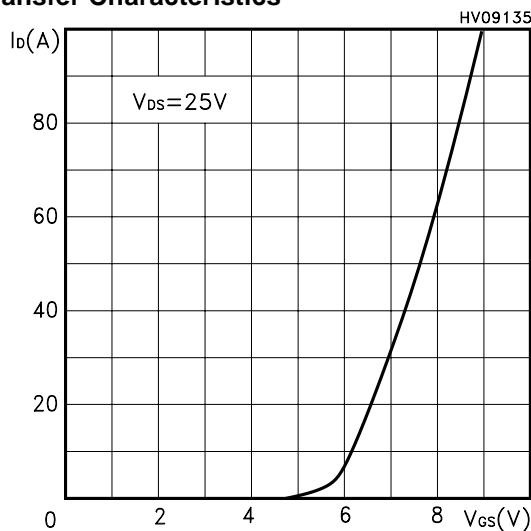

Transconductance

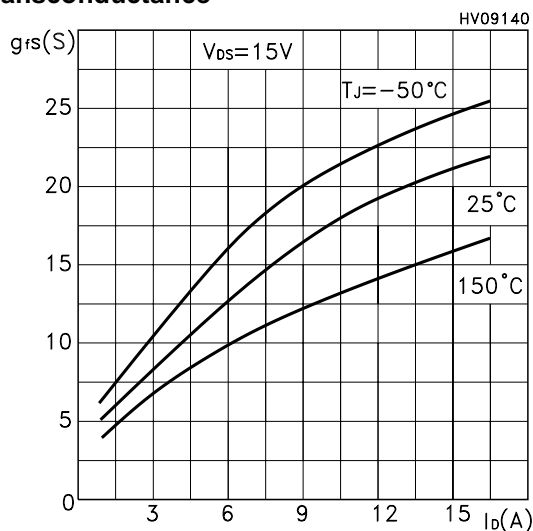

Static Drain-source On Resistance

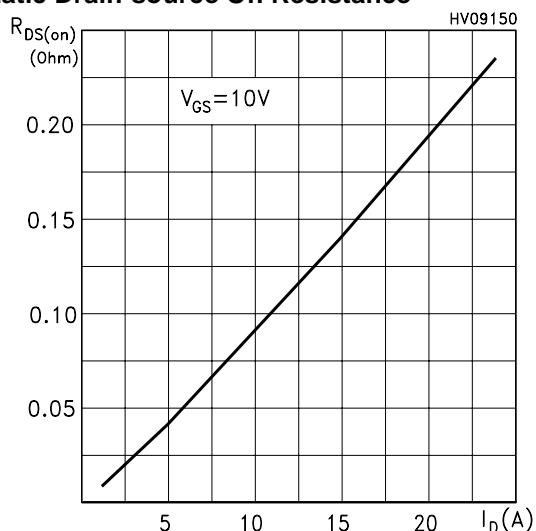

Gate Charge vs Gate-source Voltage

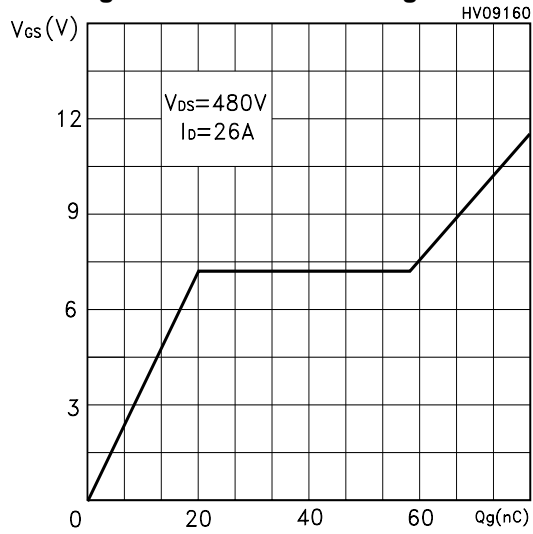

Capacitance Variations

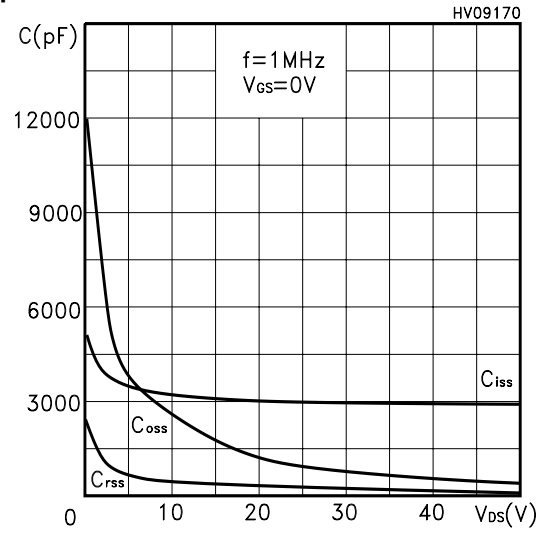

Normalized Gate Threshold Voltage vs Temp.

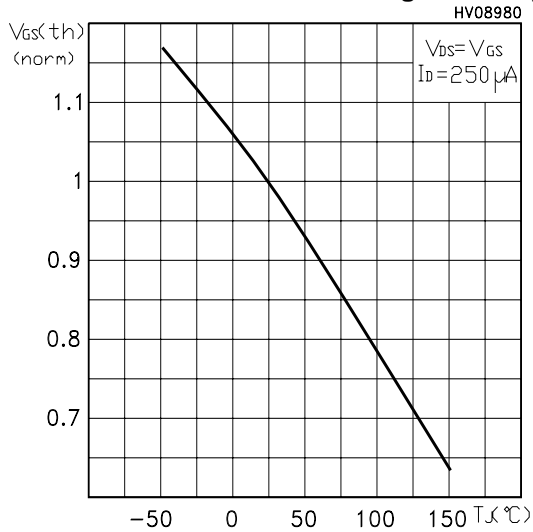

Normalized On Resistance vs Temperature

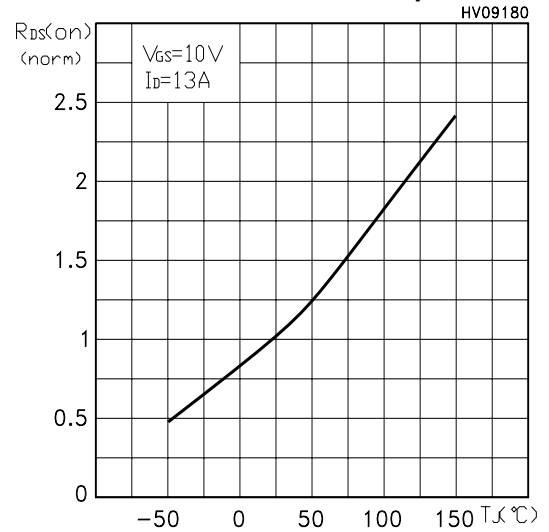

Source-drain Diode Forward Characteristics

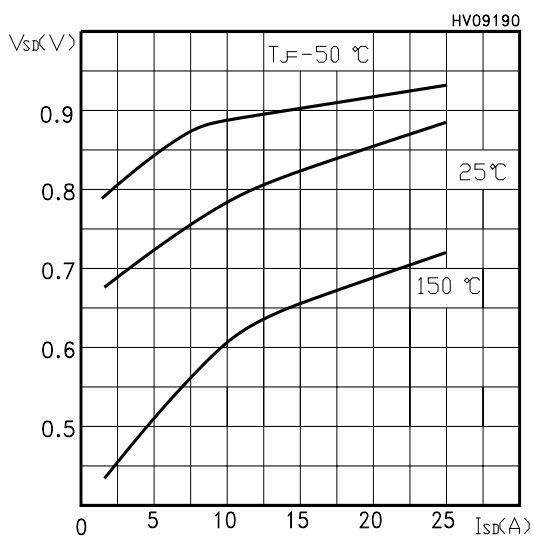

TO-247 MECHANICAL DATA

DIM.	mm.			inch		
	MIN.	TYP	MAX.	MIN.	TYP.	MAX.
A	4.85		5.15	0.19		0.20
D	2.20		2.60	0.08		0.10
E	0.40		0.80	0.015		0.03
F	1		1.40	0.04		0.05
F1		3			0.11	
F2		2			0.07	
F3	2		2.40	0.07		0.09
F4	3		3.40	0.11		0.13
G		10.90			0.43	
H	15.45		15.75	0.60		0.62
L	19.85		20.15	0.78		0.79
L1	3.70		4.30	0.14		0.17
L2		18.50			0.72	
L3	14.20		14.80	0.56		0.58
L4		34.60			1.36	
L5		5.50			0.21	
M	2		3	0.07		0.11
V		5°			5°	
V2		60°			60°	
Dia	3.55		3.65	0.14		0.143

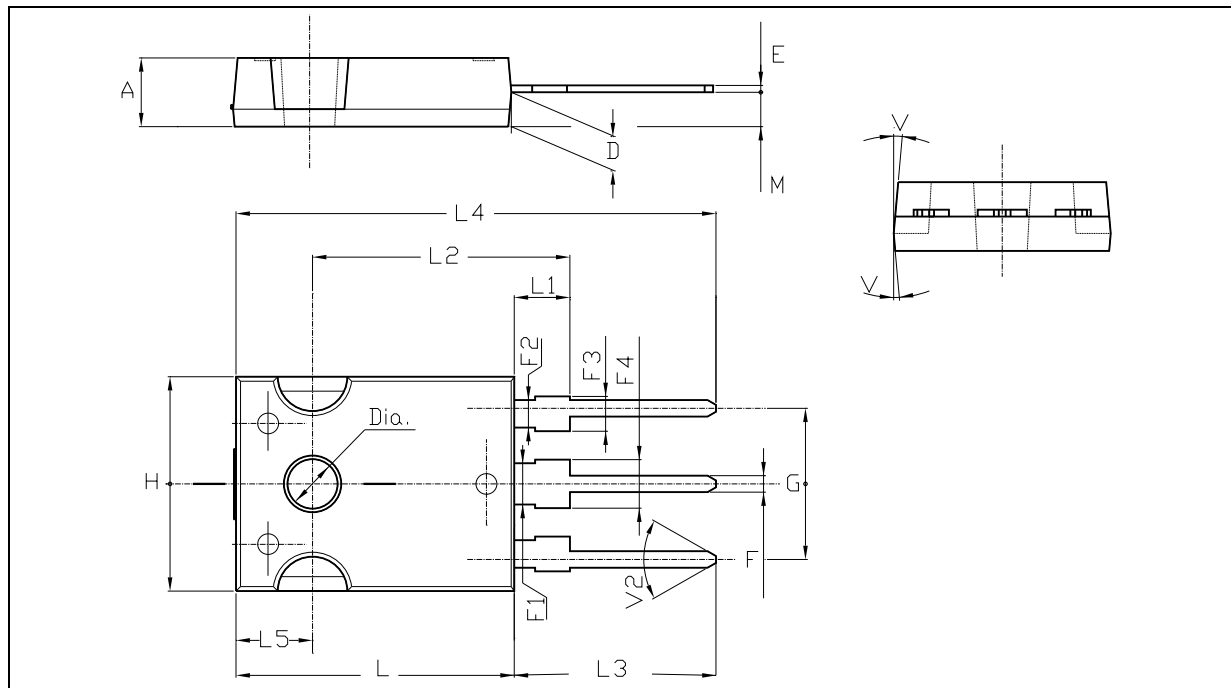

Information furnished is believed to be accurate and reliable. However, STMicroelectronics assumes no responsibility for the consequences of use of such information nor for any infringement of patents or other rights of third parties which may result from its use. No license is granted by implication or otherwise under any patent or patent rights of STMicroelectronics. Specifications mentioned in this publication are subject to change without notice. This publication supersedes and replaces all information previously supplied. STMicroelectronics products are not authorized for use as critical components in life support devices or systems without express written approval of STMicroelectronics.

© The ST logo is a registered trademark of STMicroelectronics

© 2002 STMicroelectronics - Printed in Italy - All Rights Reserved
STMicroelectronics GROUP OF COMPANIES

Australia - Brazil - Canada - China - Finland - France - Germany - Hong Kong - India - Israel - Italy - Japan - Malaysia - Malta - Morocco
Singapore - Spain - Sweden - Switzerland - United Kingdom - United States.

© <http://www.st.com>