

High Voltage Standard Rectifier

$$V_{RRM} = 2200V$$

$$I_{FAV} = 30A$$

$$V_F = 1.24V$$

Single Diode

Part number

DNA30E2200PZ

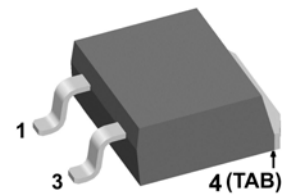

Backside: anode

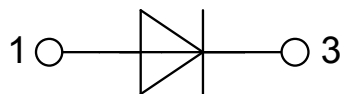

Features / Advantages:

- Planar passivated chips
- Very low leakage current
- Very low forward voltage drop
- Improved thermal behaviour

Applications:

- Diode for main rectification
- For single and three phase bridge configurations

Package: TO-263 (D2Pak-HV)

- Industry standard outline
- RoHS compliant
- Epoxy meets UL 94V-0

Rectifier				Ratings		
Symbol	Definition	Conditions	min.	typ.	max.	Unit
V_{RSM}	max. non-repetitive reverse blocking voltage	$T_{VJ} = 25^{\circ}C$			2300	V
V_{RRM}	max. repetitive reverse blocking voltage	$T_{VJ} = 25^{\circ}C$			2200	V
I_R	reverse current	$V_R = 2200 V$	$T_{VJ} = 25^{\circ}C$		40	μA
		$V_R = 2200 V$	$T_{VJ} = 150^{\circ}C$		1.5	mA
V_F	forward voltage drop	$I_F = 30 A$	$T_{VJ} = 25^{\circ}C$		1.26	V
		$I_F = 60 A$			1.53	V
		$I_F = 30 A$	$T_{VJ} = 150^{\circ}C$		1.24	V
		$I_F = 60 A$			1.63	V
I_{FAV}	average forward current	$T_C = 140^{\circ}C$ rectangular $d = 0.5$	$T_{VJ} = 175^{\circ}C$		30	A
V_{FO}	threshold voltage	} for power loss calculation only	$T_{VJ} = 175^{\circ}C$		0.83	V
r_F	slope resistance				13.4	m Ω
R_{thJC}	thermal resistance junction to case				0.7	K/W
R_{thCH}	thermal resistance case to heatsink			0.25		K/W
P_{tot}	total power dissipation		$T_C = 25^{\circ}C$		210	W
I_{FSM}	max. forward surge current	$t = 10 ms; (50 Hz), sine$	$T_{VJ} = 45^{\circ}C$		370	A
		$t = 8,3 ms; (60 Hz), sine$	$V_R = 0 V$		400	A
		$t = 10 ms; (50 Hz), sine$	$T_{VJ} = 150^{\circ}C$		315	A
		$t = 8,3 ms; (60 Hz), sine$	$V_R = 0 V$		340	A
I^2t	value for fusing	$t = 10 ms; (50 Hz), sine$	$T_{VJ} = 45^{\circ}C$		685	A ² s
		$t = 8,3 ms; (60 Hz), sine$	$V_R = 0 V$		665	A ² s
		$t = 10 ms; (50 Hz), sine$	$T_{VJ} = 150^{\circ}C$		495	A ² s
		$t = 8,3 ms; (60 Hz), sine$	$V_R = 0 V$		480	A ² s
C_J	junction capacitance	$V_R = 700 V; f = 1 MHz$	$T_{VJ} = 25^{\circ}C$		7	pF

Package TO-263 (D2Pak-HV)			Ratings			
Symbol	Definition	Conditions	min.	typ.	max.	Unit
I_{RMS}	RMS current	per terminal			35	A
T_{VJ}	virtual junction temperature		-55		175	°C
T_{op}	operation temperature		-55		150	°C
T_{stg}	storage temperature		-55		150	°C
Weight				1.5		g
F_C	mounting force with clip		20		60	N
$d_{Spp/App}$	creepage distance on surface striking distance through air	terminal to terminal	4.2			mm
$d_{Spbl/Apb}$		terminal to backside	4.7			mm

Product Marking

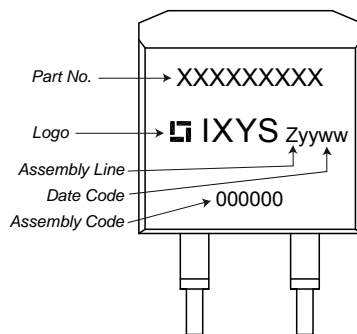

Part number

- D = Diode
- N = High Voltage Standard Rectifier
- A = ($\geq 2000V$)
- 30 = Current Rating [A]
- E = Single Diode
- 2200 = Reverse Voltage [V]
- PZ = TO-263AB (D2Pak) (2HV)

Ordering	Part Number	Marking on Product	Delivery Mode	Quantity	Code No.
Standard	DNA30E2200PZ	DNA30E2200PZ	Tape & Reel	800	514460

Similar Part	Package	Voltage class
DNA30EM2200PZ	TO-263AB (D2Pak) (2HV)	2200
DNA30E2200PA	TO-220AC	2200
DNA30E2200FE	i4-Pac (2HV)	2200
DNA30E2200IY	TO-262 (I2Pak) (2HV)	2200

Equivalent Circuits for Simulation

* on die level

$T_{VJ} = 175^\circ C$

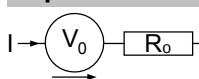

Rectifier

$V_{0\ max}$	threshold voltage	0.83	V
$R_{0\ max}$	slope resistance *	10.2	mΩ

Outlines TO-263 (D2Pak-HV)

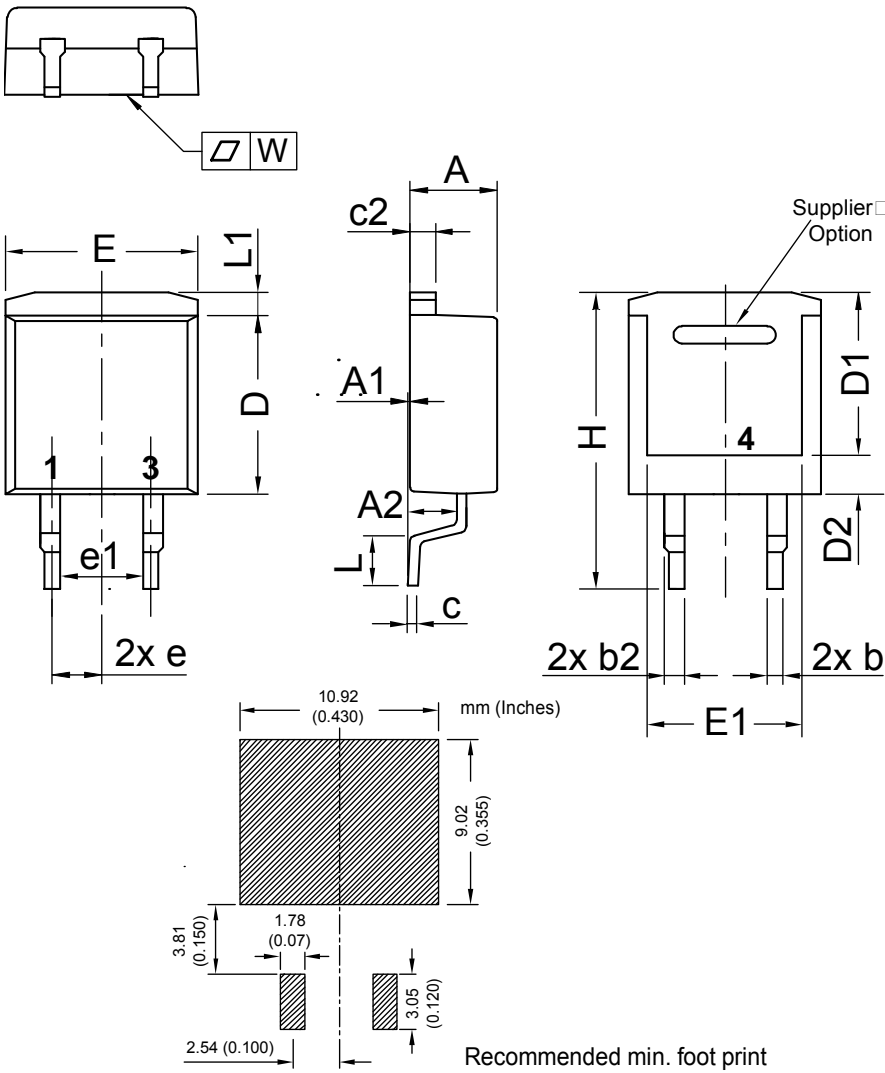

Dim.	Millimeter		Inches	
	min	max	min	max
A	4.06	4.83	0.160	0.190
A1	typ. 0.10		typ. 0.004	
A2	2.41		0.095	
b	0.51	0.99	0.020	0.039
b2	1.14	1.40	0.045	0.055
c	0.40	0.74	0.016	0.029
c2	1.14	1.40	0.045	0.055
D	8.38	9.40	0.330	0.370
D1	8.00	8.89	0.315	0.350
D2	2.3		0.091	
E	9.65	10.41	0.380	0.410
E1	6.22	8.50	0.245	0.335
e	2,54 BSC		0,100 BSC	
e1	4.28		0.169	
H	14.61	15.88	0.575	0.625
L	1.78	2.79	0.070	0.110
L1	1.02	1.68	0.040	0.066
W	typ. 0.02	0.040	typ. 0.0008	0.002

All dimensions conform with and/or within JEDEC standard.

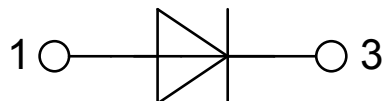

Rectifier

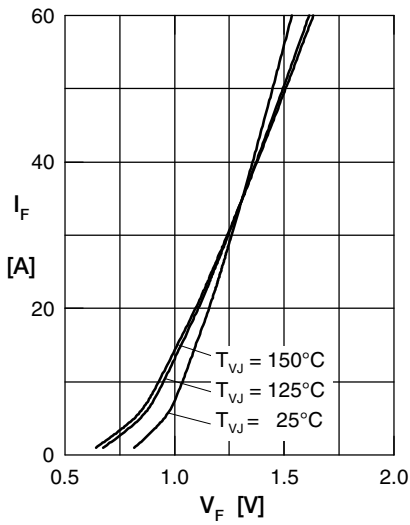

Fig. 1 Forward current versus voltage drop per diode

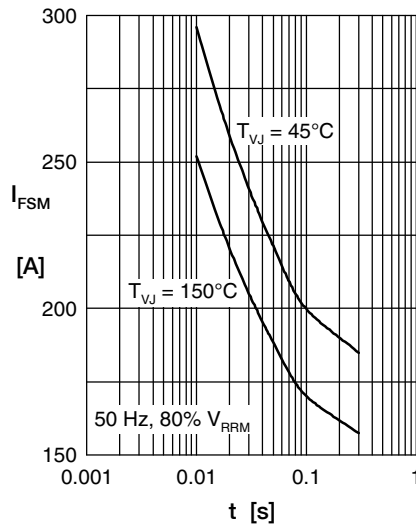

Fig. 2 Surge overload current

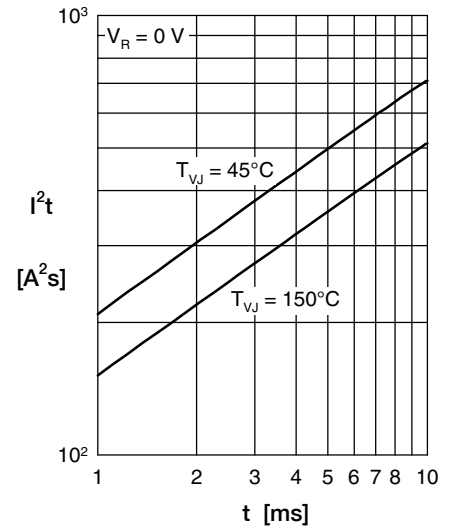

Fig. 3 I^2t versus time per diode

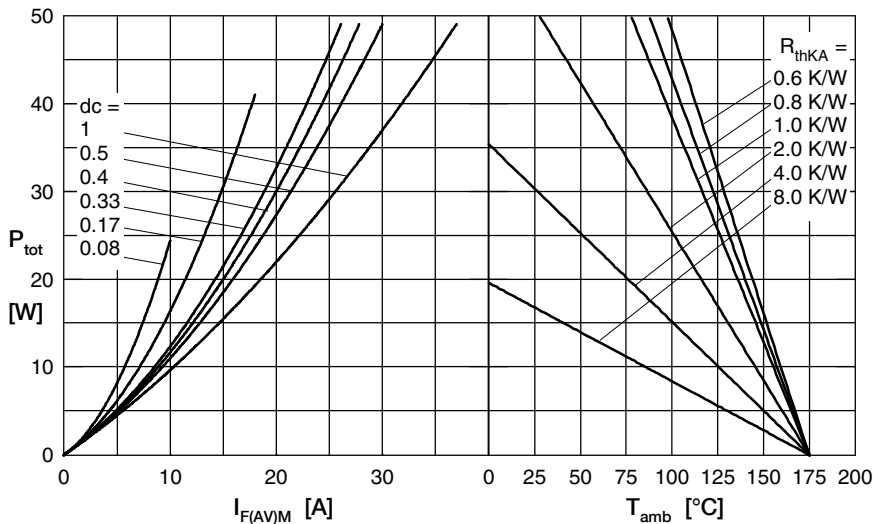

Fig. 4 Power dissipation vs. direct output current & ambient temperature

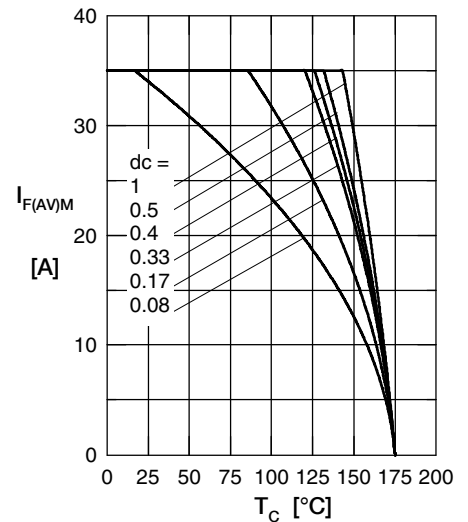

Fig. 5 Max. forward current versus case temperature

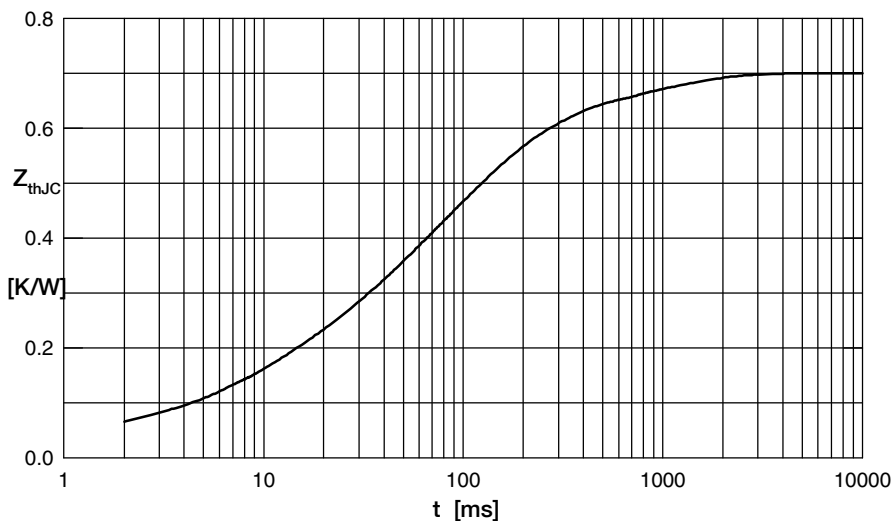

Fig. 6 Transient thermal impedance junction to case

Constants for Z_{thJC} calculation:

i	R_{thi} (K/W)	t_i (s)
1	0.03	0.0003
2	0.072	0.0065
3	0.131	0.027
4	0.367	0.105
5	0.1	0.8

Mouser Electronics

Authorized Distributor

Click to View Pricing, Inventory, Delivery & Lifecycle Information:

[IXYS:](#)

[DNA30E2200PZ](#)