

SERPAC A-21

Electronics Enclosures

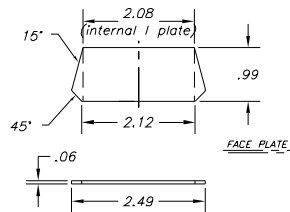
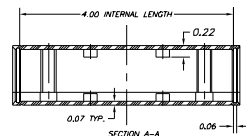
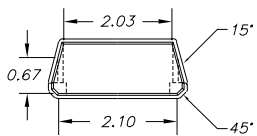
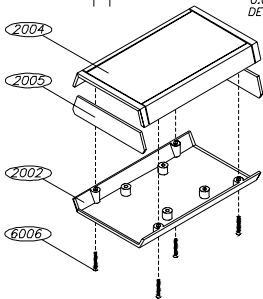
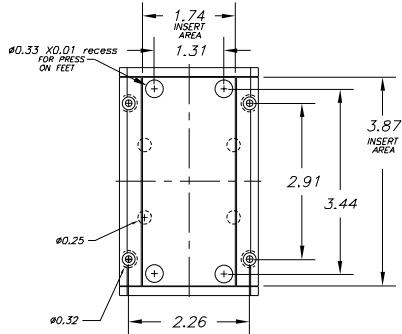
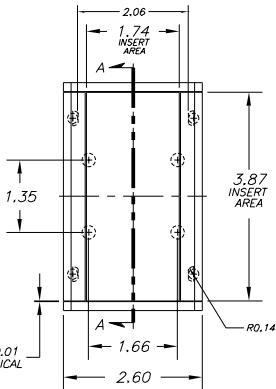
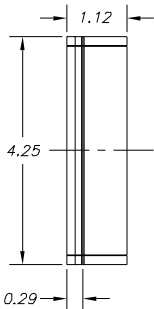

NOTES
1. WHEN MACHINE OR 1 PLATES MODIFICATIONS ARE REQUIRED, USE THE CENTER OF THE ENCLOSURE TO DIMENSION.

10-07-98

ALL DIMENSIONS ± .010

PART NO.	DESCRIPTION	PART NO.	ACCESSORIES
2004	PLASTIC TOP	52	PRESS ON FEET
2005	PLASTIC END PANEL	2005IR	INFRARED PANELS
2002	PLASTIC BOTTOM	2005CL	CLEAR & TRANSPARENT RED PANELS
6006	SCREW	2006	9 VOLT BATTERY ACCESS PANEL
		2007	PLASTIC BATTERY COVER
		2005DB9	9 PIN CONNECTOR
		2005DB25	25 PIN CONNECTOR

Mouser Electronics

Authorized Distributor

Click to View Pricing, Inventory, Delivery & Lifecycle Information:

SERPAC:

[A-21-9V-ALMOND](#) [A-21-9V-BLACK](#) [A-21-9V-GRAY](#) [A-21-GRAY](#) [A-21-ALMOND](#) [A-21-BLACK](#) [A-21-BLACK NO
PANELS 2005,BK](#)