

IEC Appliance Inlet C14 with Filter, Fuseholder 2-pole, Line Switch 2-pole



Screw-on mounting  
 from front side  
 Aluminum



Screw-on mounting  
 from front side  
 Nickel plated steel



See below:  
[Approvals and Compliances](#)

**Description**

- Panel mount :  
 Screw-on mounting from front side
- 4 Functions :  
 Appliance Inlet Protection class I , Line Switch 2-pole , Fuseholder for fuse-links 5 x 20 mm 2-pole , Line filter in standard and medical version
- Quick connect terminals 6.3 x 0.8 mm

**Characteristics**

- Compact design with optimal shielding
- All single elements are already wired
- Plug removal necessary for fuse-link replacement
- With EMC-shield
- Suitable for use in medical equipment according to IEC/UL 60601-1  
 For applications according IEC/UL 62368-1 we recommend variants with bleed resistor

**Other versions on request**

- Medical Version (M80)

**References**

- Alternative: version with 2-stage filter [FKID](#)
- Alternative: version without line filter [6765](#)

**Weblinks**

[pdf data sheet](#), [html datasheet](#), [General Product Information](#), [Approvals](#), [Distributor-Stock-Check](#), [Accessories](#), [Detailed request for product](#)

**Technical Data**

|                                 |   |                                   |  |
|---------------------------------|---|-----------------------------------|--|
| Ratings IEC                     | 1 - 10A @ Ta 40 °C / 250VAC; 50Hz   | Appliance inlet/-outlet           | C14 acc. to IEC 60320-1, UL 498, CSA C22.2 no. 42 (for cold conditions) pin-temperature 70 °C, 10A, Protection Class I |
| Ratings UL/CSA                  | 1 - 10A @ Ta 40 °C / 250VAC; 60Hz   | Fuseholder                        | 2-pole, Shocksafe category PC2 acc. to IEC 60127-6, for fuse-links 5 x 20mm  |
| Leakage Current                 | standard < 0.25mA (250V / 60Hz)<br>medical < 5 µA (250 V / 60 Hz)         | Rated Power Acceptance @ Ta 23 °C | 5 x 20: 1.6W (2-pole)  |
| Dielectric Strength             | > 1.7kVDC between L-N<br>> 2.7kVDC between L/N-PE<br>Test voltage (2 sec) | Power Acceptance @ Ta > 23°C      | Admissible power acceptance at higher ambient temperature see derating curves  |
| Allowable Operation Temperature | -25°C to 85°C   | Line Switch                       | 2-pole, non-illuminated, acc. to IEC 61058-1<br><a href="#">Technical Details</a>                                      |
| Climatic Category               | 25/085/21 acc. to IEC 60068-1   | Line Filter                       | Standard and Medical Version, IEC 60939, UL 1283, CSA C22.2 no. 8<br><a href="#">Technical Details</a>                 |
| IP-Protection                   | from front side IP40 acc. to IEC 60529                                    | MTBF                              | > 1'700'000h acc. to MIL-HB-217 F  |
| Protection Class                | Suitable for appliances with protection class I acc. to IEC 61140         |                                   |  |
| Terminal                        | Quick connect terminals 6.3 x 0.8 mm                                      |                                   |  |
| Panel Thickness S               | Screw: max 8 mm<br>Mounting screw torque max 0.5Nm                        |                                   |  |
| Material: Housing               | Thermoplastic, black, UL 94V-0  |                                   |  |

**Approvals and Compliances**



Detailed information on product approvals, code requirements, usage instructions and detailed test conditions can be looked up in [Details about Approvals](#)

SCHURTER products are designed for use in industrial environments. They have approvals from independent testing bodies according to national and international standards. Products with specific characteristics and requirements such as required in the automotive sector according to IATF 16949, medical technology according to ISO 13485 or in the aerospace industry can be offered exclusively with customer-specific, individual agreements by SCHURTER.

## Approvals









The approval mark is used by the testing authorities to certify compliance with the safety requirements placed on electronic products.

Approval Reference Type: FKI

| Approval Logo  | Certificates                  | Certification Body | Description                  |
|--|-------------------------------|--------------------|------------------------------|
|  | <a href="#">VDE Approvals</a> | VDE                | Certificate Number: 40004665 |
|  | <a href="#">UL Approvals</a>  | UL                 | UL File Number: E72928       |

## Product standards

Product standards that are referenced

| Organization   | Design                | Standard         | Description   |
|--|-----------------------|------------------|---|
|  | Designed according to | IEC 60320-1      | Appliance couplers for household and similar general purposes         |
|  | Designed according to | IEC 60939        | Passive filters for suppressing electromagnetic interference          |
|  | Designed according to | IEC 60127-6      | Miniature fuses. Part 6. Fuse-holders for miniature fuse-links        |
|  | Designed according to | IEC 61058-1      | Switches for appliances. Part 1. General requirements                 |
|  | Designed according to | UL 498           | Standard for Attachment Plugs and Receptacles                         |
|  | Designed according to | UL 1283          | Electromagnetic interference filters                                  |
|  | Designed according to | CSA C22.2 no. 42 | General Use Receptacles, Attachment Plugs, and Similar Wiring Devices |
|  | Designed according to | CSA C22.2 no. 8  | Electromagnetic interference (EMI) filters                            |







## Application standards

Application standards where the product can be used

| Organization   | Design                         | Standard     | Description  |
|--|--------------------------------|--------------|--|
|  | Designed for applications acc. | IEC/UL 60950 | IEC 60950-1 includes the basic requirements for the safety of information technology equipment.  |
|  | Designed for applications acc. | IEC 60601-1  | Medical electrical equipment - Part 1: General requirements for basic safety and essential performance   |
|  | Designed for applications acc. | IEC 60335-1  | Safety of electrical appliances for household and similar purposes. Meets the requirements for appliances in unattended use. This includes the enhanced requirements of glow wire tests acc. to IEC 60695-2-11 or -12 & -13. |

## Compliances

The product complies with following Guide Lines

| Identification   | Details                                      | Initiator   | Description   |
|--|--|-------------|---|
|  | <a href="#">CE declaration of conformity</a> | SCHURTER AG | The CE marking declares that the product complies with the applicable requirements laid down in the harmonisation of Community legislation on its affixing in accordance with EU Regulation 765/2008. |
|  | RoHS   | SCHURTER AG | Directive RoHS 2011/65/EU, Amendment (EU) 2015/863  |
|  | China RoHS                                   | SCHURTER AG | The law SJ / T 11363-2006 (China RoHS) has been in force since 1 March 2007. It is similar to the EU directive RoHS.  |
|  | REACH  | SCHURTER AG | On 1 June 2007, Regulation (EC) No 1907/2006 on the Registration, Evaluation, Authorization and Restriction of Chemicals 1 (abbreviated as "REACH") entered into force.                               |
|  | White Paper Glow wire test                   | SCHURTER AG | Meets the requirements of IEC 60335-1 for appliances in unattended use. This includes the enhanced requirements of glow wire tests acc. to IEC 60695-2-11 or -12 & -13.                               |
|  | Medical Technology                           | SCHURTER AG | Suitable for use in medical equipment according to IEC/UL 60601-1   |

Dimension [mm]

Case 45

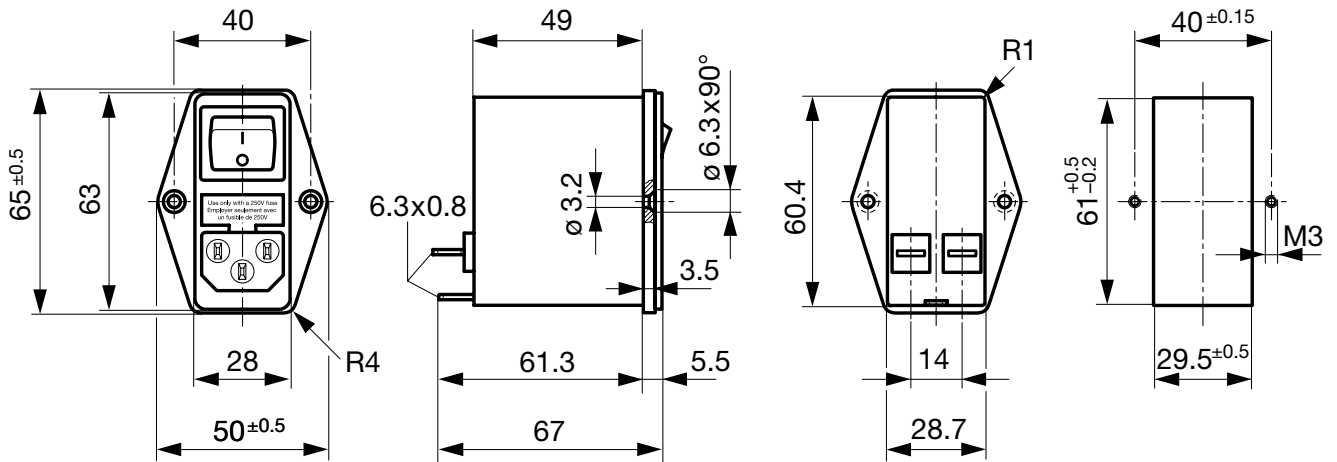

Case 50

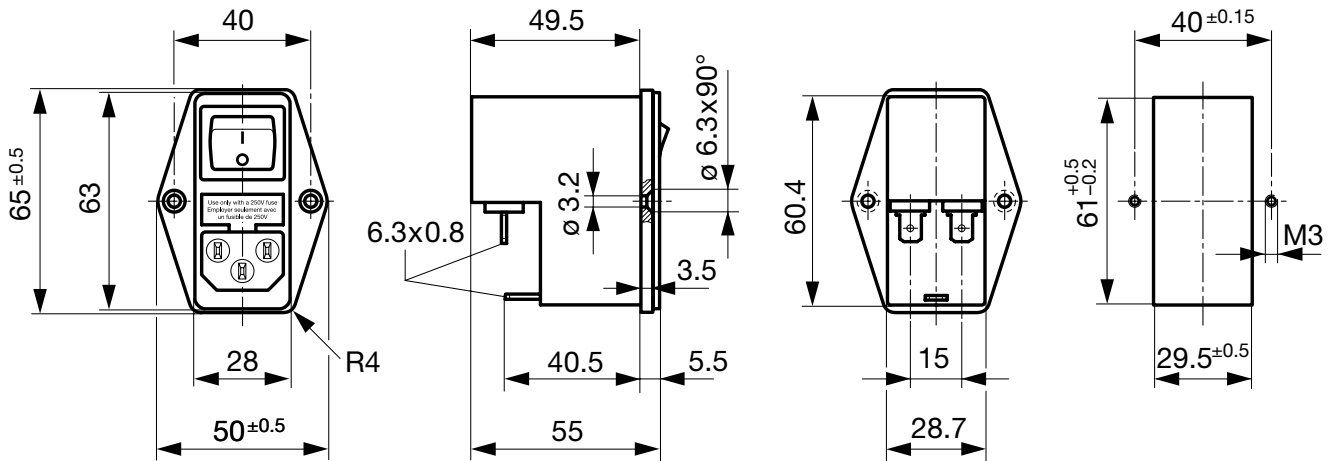

Technical Data of Filter-Components

| Rated Current [A] | Filter-Type          | Inductances L [mH] | Capacitance CX [nF] | Capacitance CY [nF] | R [MΩ] |
|-------------------|----------------------|--------------------|---------------------|---------------------|--------|
| 1                 | Standard version     | 2 x 10             | 68                  | 2.2                 | 1      |
| 2                 | Standard version     | 2 x 4              | 68                  | 2.2                 | 1      |
| 4                 | Standard version     | 2 x 1.5            | 68                  | 2.2                 | 1      |
| 6                 | Standard version     | 2 x 0.8            | 68                  | 2.2                 | 1      |
| 10                | Standard version     | 2 x 0.3            | 68                  | 2.2                 | 1      |
| 1                 | Medical Version (M5) | 2 x 10             | 68                  | -                   | 1      |
| 2                 | Medical Version (M5) | 2 x 4              | 68                  | -                   | 1      |
| 4                 | Medical Version (M5) | 2 x 1.5            | 68                  | -                   | 1      |
| 6                 | Medical Version (M5) | 2 x 0.8            | 68                  | -                   | 1      |
| 10                | Medical Version (M5) | 2 x 0.3            | 68                  | -                   | 1      |

Diagrams

Standard version

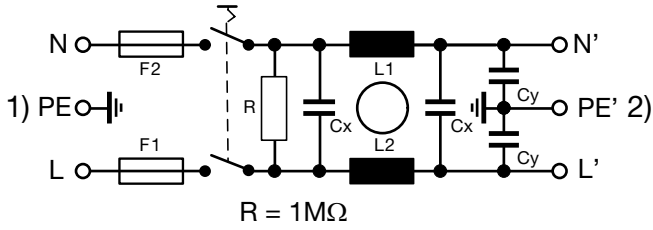

1) Line  
 2) Load

Medical Version (M5)

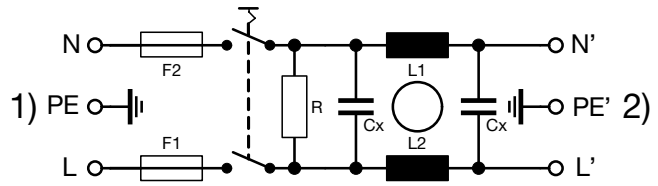

1) Line  
 2) Load

Derating Curves

2-pole

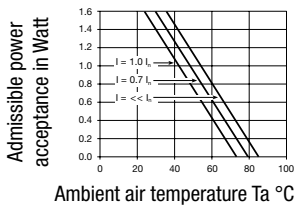

Attenuation Loss

----- 50Ω differential mode \_\_\_\_\_ 50Ω common mode

Standard version

1 A

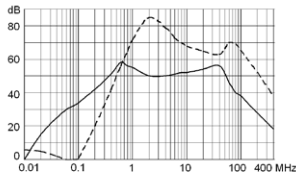

2 A

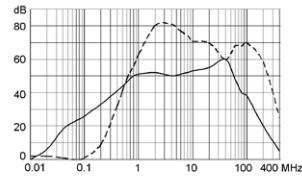

4 A

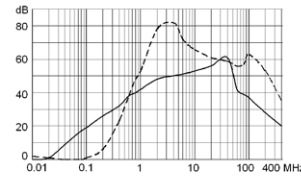

6 A

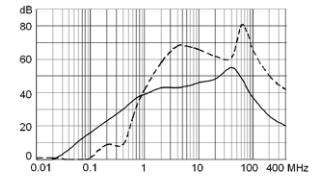

10 A

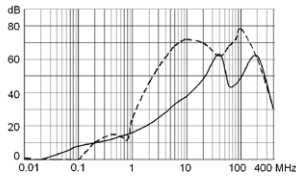

Medical version (M5)

1 A

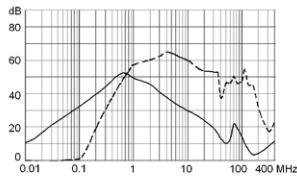

2 A

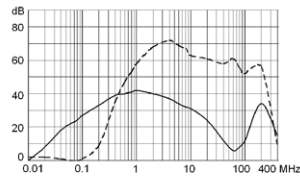

4 A

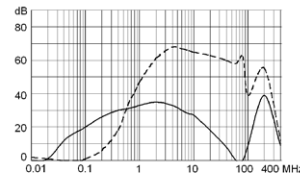

6 A

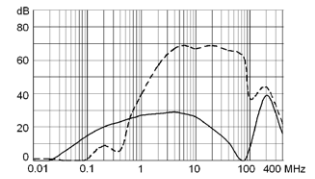

10 A

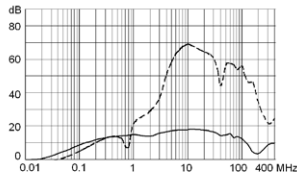

### All Variants

| Type | Rated Current [A] | Filter-Type          | Fuseholder | Line Switch | Housings | Material: Housing   | Order Number |
|------|-------------------|----------------------|------------|-------------|----------|---------------------|--------------|
| FKI  | 1                 | Standard version     | 2-pole     | 2-pole      | 45       | Aluminum            | 4304.4061    |
| FKI  | 2                 | Standard version     | 2-pole     | 2-pole      | 45       | Aluminum            | 4304.4062    |
| FKI  | 4                 | Standard version     | 2-pole     | 2-pole      | 45       | Aluminum            | 4304.4063    |
| FKI  | 6                 | Standard version     | 2-pole     | 2-pole      | 45       | Aluminum            | 4304.4064    |
| FKI  | 10                | Standard version     | 2-pole     | 2-pole      | 45       | Aluminum            | 4304.4065    |
| FKI  | 1                 | Medical Version (M5) | 2-pole     | 2-pole      | 45       | Aluminum            | 4304.4091    |
| FKI  | 2                 | Medical Version (M5) | 2-pole     | 2-pole      | 45       | Aluminum            | 4304.4092    |
| FKI  | 4                 | Medical Version (M5) | 2-pole     | 2-pole      | 45       | Aluminum            | 4304.4093    |
| FKI  | 6                 | Medical Version (M5) | 2-pole     | 2-pole      | 45       | Aluminum            | 4304.4094    |
| FKI  | 10                | Medical Version (M5) | 2-pole     | 2-pole      | 45       | Aluminum            | 4304.4095    |
| FKI  | 1                 | Standard version     | 2-pole     | 2-pole      | 50       | Nickel plated steel | 4304.4021    |
| FKI  | 2                 | Standard version     | 2-pole     | 2-pole      | 50       | Nickel plated steel | 4304.4022    |
| FKI  | 4                 | Standard version     | 2-pole     | 2-pole      | 50       | Nickel plated steel | 4304.4023    |
| FKI  | 6                 | Standard version     | 2-pole     | 2-pole      | 50       | Nickel plated steel | 4304.4024    |
| FKI  | 10                | Standard version     | 2-pole     | 2-pole      | 50       | Nickel plated steel | 4304.4025    |
| FKI  | 1                 | Medical Version (M5) | 2-pole     | 2-pole      | 50       | Nickel plated steel | 4304.4066    |
| FKI  | 2                 | Medical Version (M5) | 2-pole     | 2-pole      | 50       | Nickel plated steel | 4304.4067    |
| FKI  | 4                 | Medical Version (M5) | 2-pole     | 2-pole      | 50       | Nickel plated steel | 4304.4068    |
| FKI  | 6                 | Medical Version (M5) | 2-pole     | 2-pole      | 50       | Nickel plated steel | 4304.4069    |
| FKI  | 10                | Medical Version (M5) | 2-pole     | 2-pole      | 50       | Nickel plated steel | 4304.4070    |

Most Popular.

Availability for all products can be searched real-time: <https://www.schurter.com/en/Stock-Check/Stock-Check-SCHURTER>

Packaging unit

10 Pcs

Accessories

Description

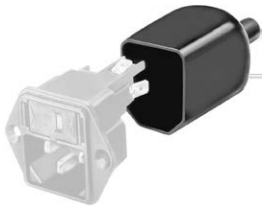

Assorted Covers  
 Rear Cover

0859.0074

Mating Outlets/Connectors

Category / Description

[Appliance Outlet Overview complete](#)



4787, Mounting: Screw-on mounting, Appliance Outlet: IEC Solder terminals, 10 A, Suitable for appliances with protection class I 4787

4788, Mounting: Snap-in version, Appliance Outlet: IEC Solder terminals or quick connect terminals, 10 A, Suitable for appliances with protection class I 4788

IEC Appliance Outlet F or H, Screw-on Mounting, Front Side, Solder, PCB or Quick-connect Terminal 5091

[Appliance Outlet further types to FKI](#)

[Connector Overview complete](#)



4022 Mounting: Power Supply Cord, 3 x 1.5 mm<sup>2</sup>, Screw clamps, Connector: IEC C13 4022

4782 Mounting: Power Cord, 3 x 1 mm<sup>2</sup> / 3 x 18 AWG, Cable, Connector: IEC C13 4782

4012 Mounting: Power Supply Cord, 3 x 1 mm<sup>2</sup>, Screw clamps, Connector: IEC C13 4012

4785 Mounting: Power Cord, 3 x 1 mm<sup>2</sup> / 3 x 18 AWG, Cable, Connector: IEC C13 4785

4300-06 Mounting: Power Cord, 3 x 1 mm<sup>2</sup> / 3 x 18 AWG, Cable, Connector: IEC C13 4300-06

[Connector further types to FKI](#)

...

# Mouser Electronics

Authorized Distributor

Click to View Pricing, Inventory, Delivery & Lifecycle Information:

## Schurter:

[4304.4022](#) [4304.4024](#) [4304.4025](#) [4304.4069](#) [4304.4028](#) [4304.4062](#) [4304.4064](#) [4304.4067](#) [4304.4068](#) [4304.4061](#)  
[4304.4063](#) [4304.4065](#) [4304.4095](#) [4304.407](#) [4304.4070](#)