

<For Tr1(PNP)>

Parameter	Value
$V_{CEO}$	-50V
$I_C$	-150mA

<For Tr2(NPN)>

Parameter	Value
$V_{CEO}$	50V
$I_C$	150mA

### ● Outline

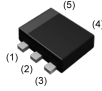
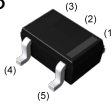
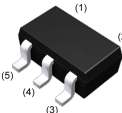
<p>SOT-553</p>  <p>EMY1 (EMT5)</p>	<p>SOT-353</p>  <p>UMY1N (UMT5)</p>
<p>SOT-25</p>  <p>FMY1A (SMT5)</p>	

### ● Features

- 1) Included a 2SA1037AK and a 2SC2412K transistor in a EMT, UMT or SMT package.
- 2) Mounting possible with EMT3 or UMT3 or SMT3 automatic mounting machines.
- 3) PNP and NPN transistors have common emitters.
- 4) Mounting cost and area can be cut in half.

### ● Application

GENERAL PURPOSE SMALL SIGNAL AMPLIFIER

### ● Inner circuit

EMY1 / UMY1N

- (1) Tr1 Base
- (2) Tr1/Tr2 Emitter
- (3) Tr2 Base
- (4) Tr2 Collector
- (5) Tr1 Collector

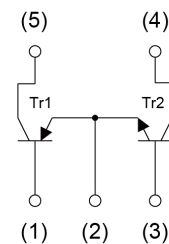

FMY1A

- (1) Tr1 Collector
- (2) Tr2 Collector
- (3) Tr2 Base
- (4) Tr1/Tr2 Emitter
- (5) Tr1 Base

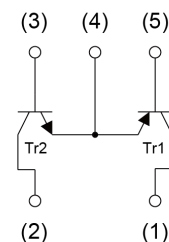

### ● Packaging specifications

Part No.	Package	Package size	Taping code	Reel size (mm)	Tape width (mm)	Basic ordering unit.(pcs)	Marking
EMY1	SOT-553 (EMT5)	1616	T2R	180	8	8000	Y1
UMY1N	SOT-353 (UMT5)	2021	TR	180	8	3000	Y1
FMY1A	SOT-25 (SMT5)	2928	T148	180	8	3000	Y1

● Absolute maximum ratings (T<sub>a</sub> = 25°C)

Parameter		Symbol	Tr1(PNP)	Tr2(NPN)	Unit
Collector-base voltage		V <sub>CBO</sub>	-60	60	V
Collector-emitter voltage		V <sub>CEO</sub>	-50	50	V
Emitter-base voltage		V <sub>EBO</sub>	-6	7	V
Collector current		I <sub>C</sub>	-150	150	mA
Power dissipation	EMY1/ UMY1N	P <sub>D</sub> <sup>*1*2</sup>	150		mW/Total
	FMY1A	P <sub>D</sub> <sup>*1*3</sup>	300		mW/Total
Junction temperature		T <sub>j</sub>	150		°C
Range of storage temperature		T <sub>stg</sub>	-55 to +150		°C

● Electrical characteristics (T<sub>a</sub> = 25°C) <For Tr1(PNP)>

Parameter	Symbol	Conditions	Values			Unit
			Min.	Typ.	Max.	
Collector-base breakdown voltage	BV <sub>CBO</sub>	I <sub>C</sub> = -50μA	-60	-	-	V
Collector-emitter breakdown voltage	BV <sub>CEO</sub>	I <sub>C</sub> = -1mA	-50	-	-	V
Emitter-base breakdown voltage	BV <sub>EBO</sub>	I <sub>E</sub> = -50μA	-6	-	-	V
Collector cut-off current	I <sub>CBO</sub>	V <sub>CB</sub> = -60V	-	-	-100	nA
Emitter cut-off current	I <sub>EBO</sub>	V <sub>EB</sub> = -6V	-	-	-100	nA
Collector-emitter saturation voltage	V <sub>CE(sat)</sub>	I <sub>C</sub> = -50mA, I <sub>B</sub> = -5mA	-	-	-500	mV
DC current gain	h <sub>FE</sub>	V <sub>CE</sub> = -6V, I <sub>C</sub> = -1mA	120	-	560	-
Transition frequency	f <sub>T</sub>	V <sub>CE</sub> = -12V, I <sub>E</sub> = 2mA, f = 100MHz	-	140	-	MHz
Output capacitance	C <sub>ob</sub>	V <sub>CB</sub> = -12V, I <sub>E</sub> = 0mA, f = 1MHz	-	4.0	5.0	pF

● Electrical characteristics (T<sub>a</sub> = 25°C) <For Tr2(NPN)>

Parameter	Symbol	Conditions	Values			Unit
			Min.	Typ.	Max.	
Collector-base breakdown voltage	BV <sub>CBO</sub>	I <sub>C</sub> = 50μA	60	-	-	V
Collector-emitter breakdown voltage	BV <sub>CEO</sub>	I <sub>C</sub> = 1mA	50	-	-	V
Emitter-base breakdown voltage	BV <sub>EBO</sub>	I <sub>E</sub> = 50μA	7	-	-	V
Collector cut-off current	I <sub>CBO</sub>	V <sub>CB</sub> = 60V	-	-	100	nA
Emitter cut-off current	I <sub>EBO</sub>	V <sub>EB</sub> = 7V	-	-	100	nA
Collector-emitter saturation voltage	V <sub>CE(sat)</sub>	I <sub>C</sub> = 50mA, I <sub>B</sub> = 5mA	-	-	400	V
DC current gain	h <sub>FE</sub>	V <sub>CE</sub> = 6V, I <sub>C</sub> = 1mA	120	-	560	-
Transition frequency	f <sub>T</sub>	V <sub>CE</sub> = 12V, I <sub>E</sub> = -2mA, f = 100MHz	-	180	-	MHz
Output capacitance	C <sub>ob</sub>	V <sub>CB</sub> = 12V, I <sub>E</sub> = 0A, f = 1MHz	-	2.0	3.5	pF

- \*1 Each terminal mounted on a referenve land.
- \*2 120mW per element must not be exceeded.
- \*3 200mW per element must not be exceeded.

●Electrical characteristic curves( $T_a=25^{\circ}\text{C}$  <For Tr1(PNP)>

Fig.1 Ground Emitter Propagation Characteristics

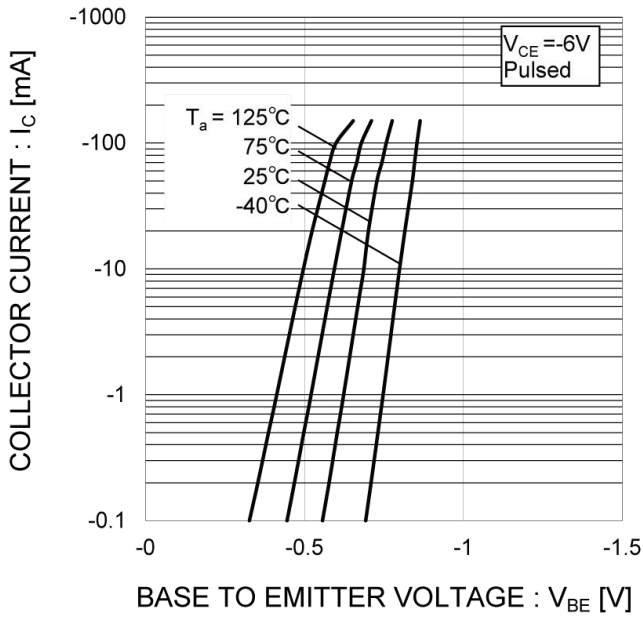

Fig.2 Grounded Emitter Output Characteristics

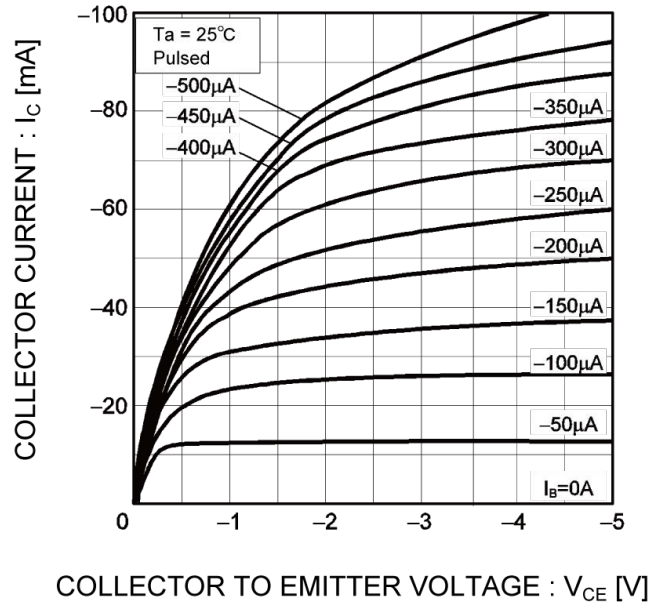

Fig.3 DC Current Gain vs. Collector Current (I)

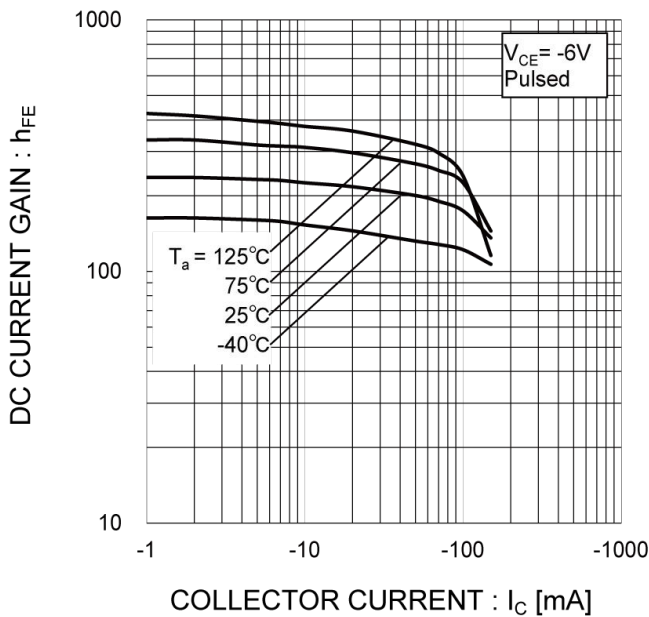
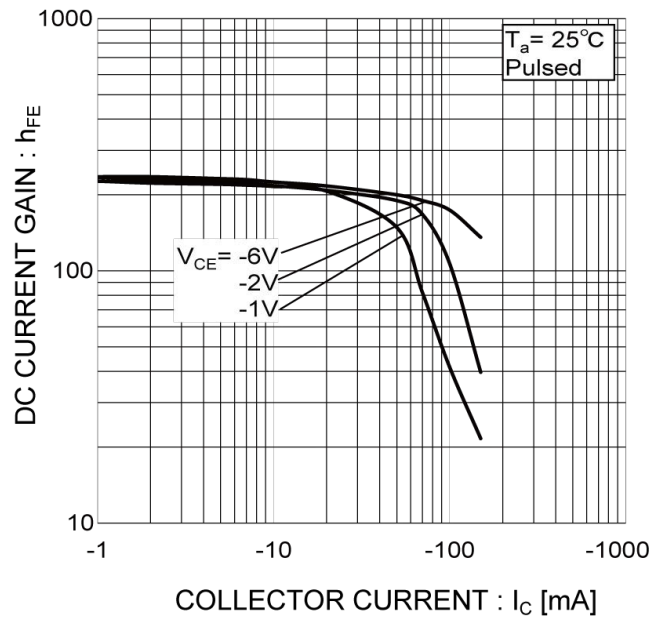

Fig.4 DC Current Gain vs. Collector Current (II)



●Electrical characteristic curves( $T_a=25^{\circ}\text{C}$  <For Tr1(PNP)>

Fig.5 Collector-Emitter Saturation Voltage vs. Collector Current(I)

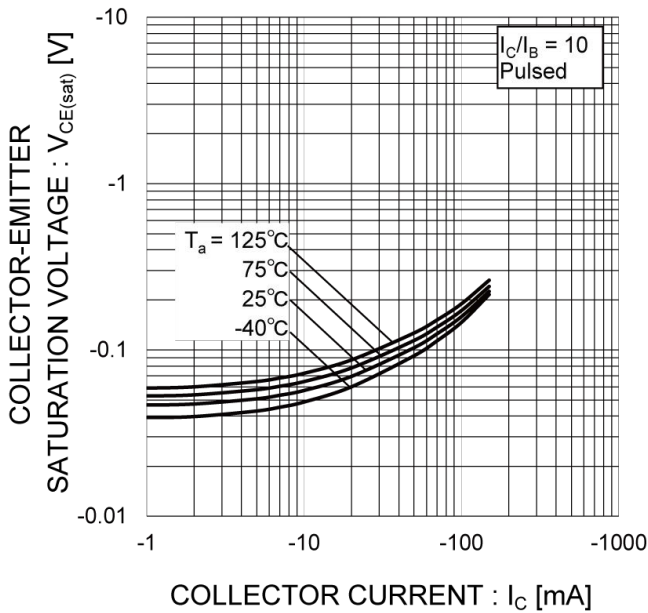

Fig.6 Collector-Emitter Saturation Voltage vs. Collector Current(II)

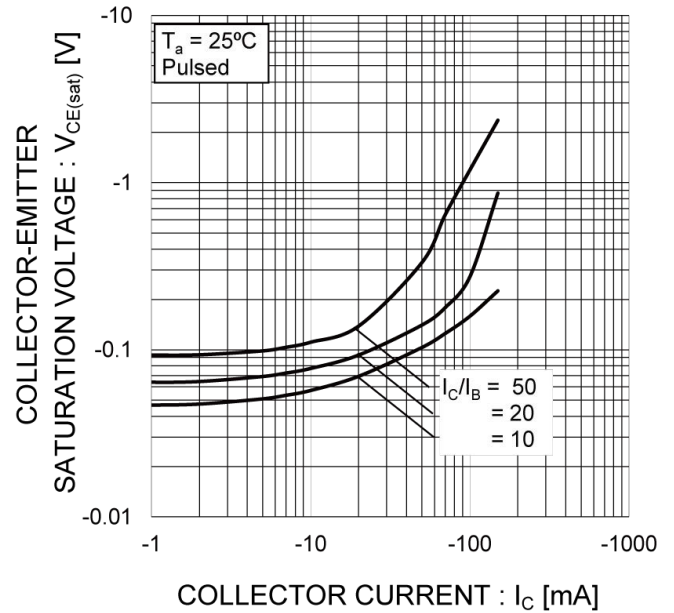

Fig.7 Base-Emitter Saturation Voltage vs. Collector Current (I)

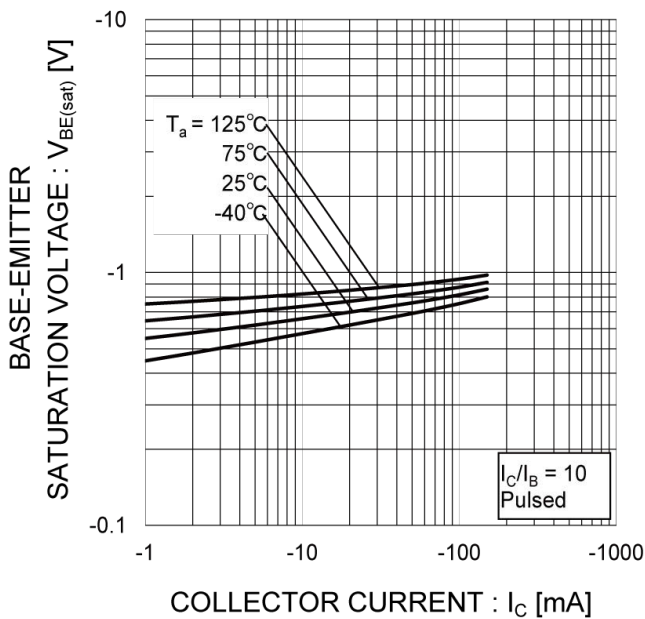
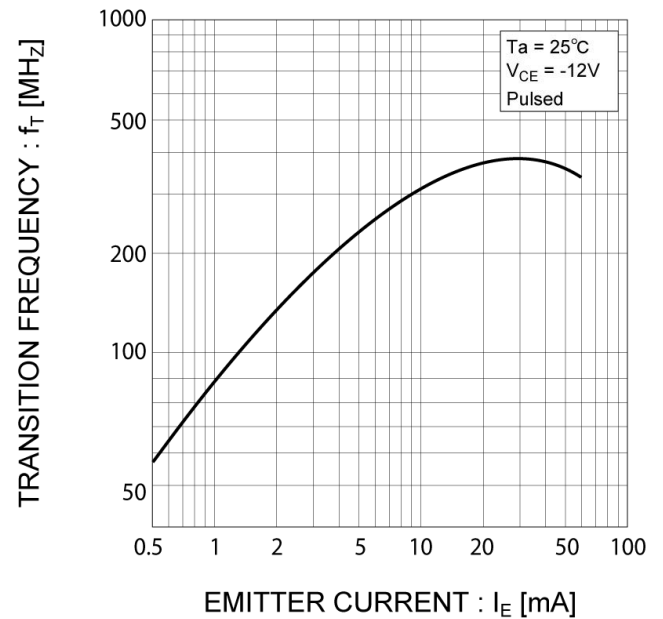

Fig.8 Gain Bandwidth Product vs. Emitter Current



●Electrical characteristic curves( $T_a=25^{\circ}\text{C}$ ) <For Tr1(PNP)>

Fig.9 Collector Output Capacitance vs. collector-Base Voltage  
Emitter Input Capacitance vs. Emitter-Base Voltage

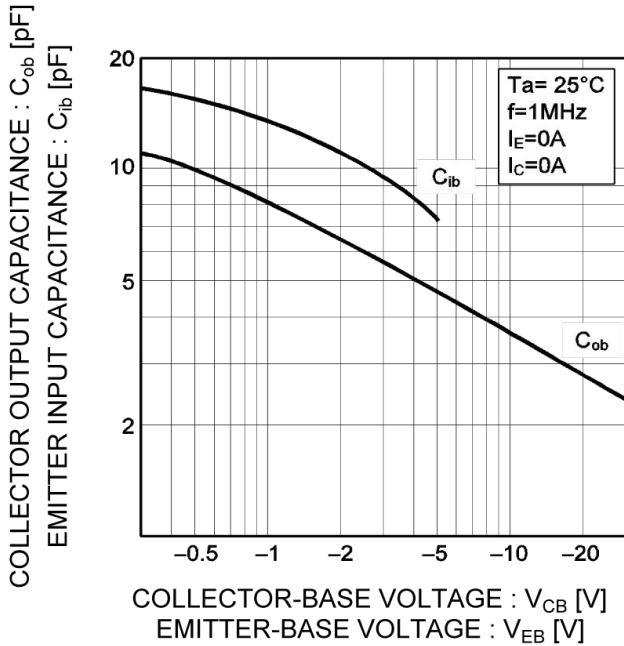

Fig.10 Safe Operating Area

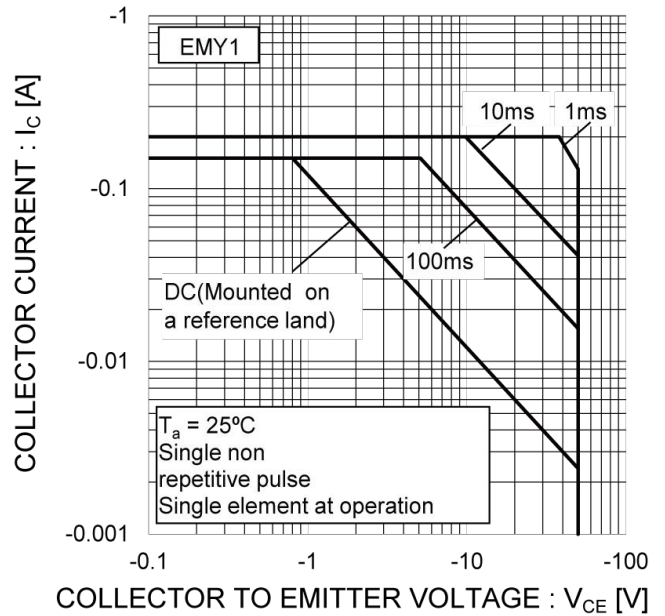

Fig.11 Safe Operating Area

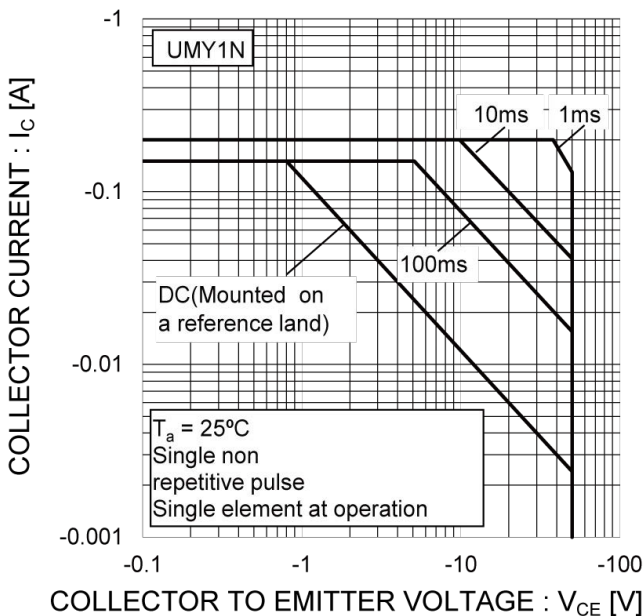
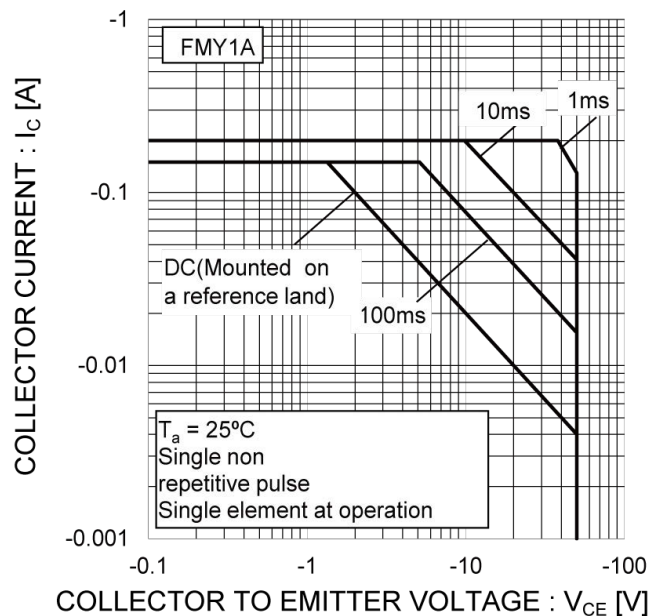

Fig.12 Safe Operating Area



●Electrical characteristic curves( $T_a=25^{\circ}\text{C}$ ) <For Tr2(NPN)>

Fig.13 Ground Emitter Propagation Characteristics

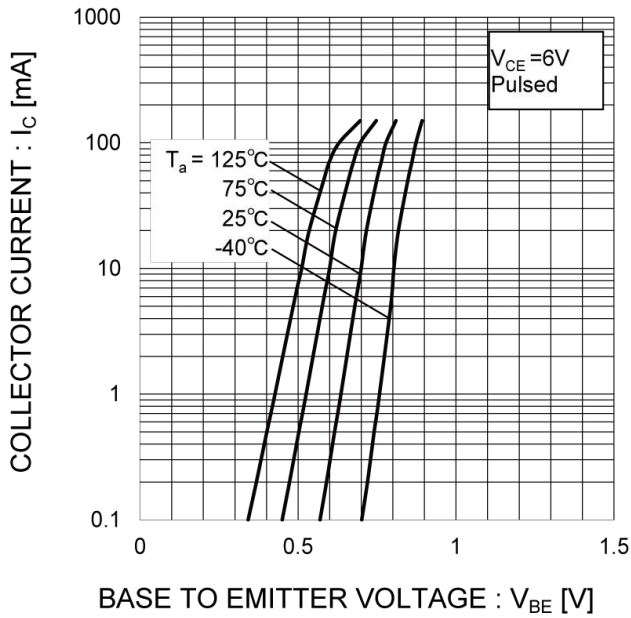

Fig.14 Grounded Emitter Output Characteristics

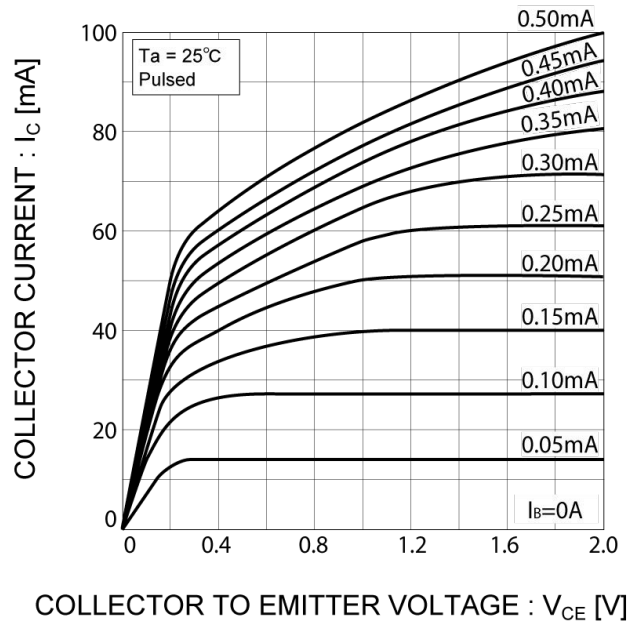

Fig.15 DC Current Gain vs. Collector Current (I)

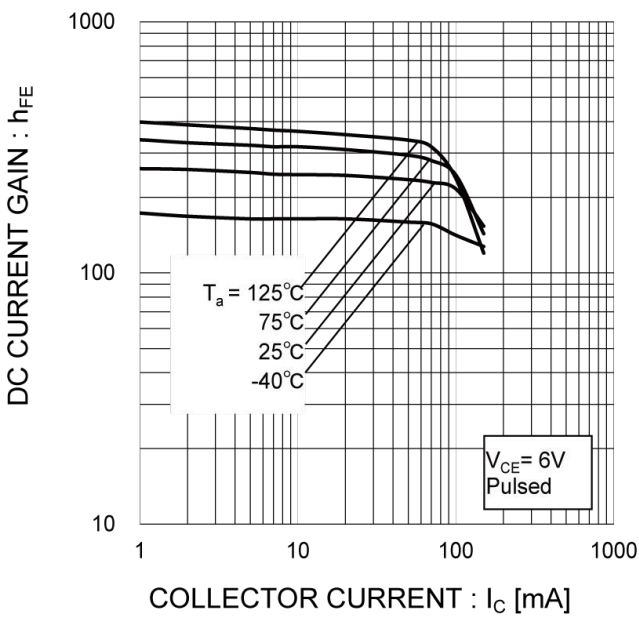
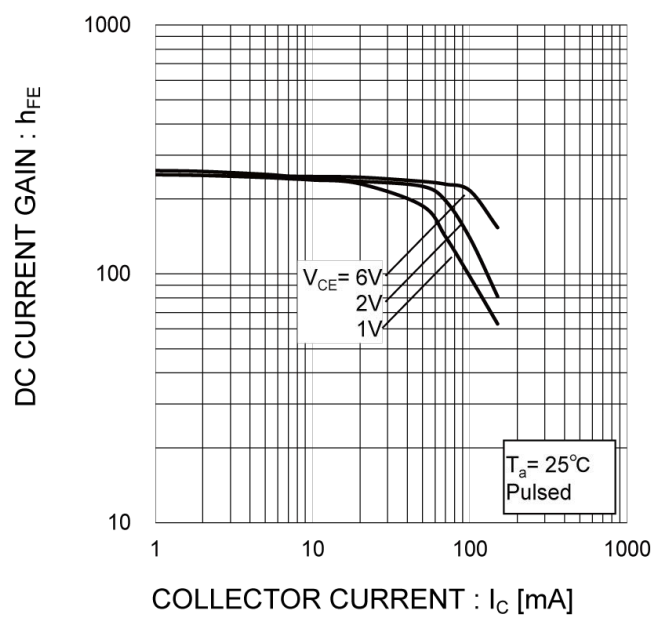

Fig.16 DC Current Gain vs. Collector Current (II)



●Electrical characteristic curves ( $T_a = 25^\circ\text{C}$ ) <For Tr2(NPN)>

Fig.17 Collector-Emitter Saturation Voltage vs. Collector Current(I)

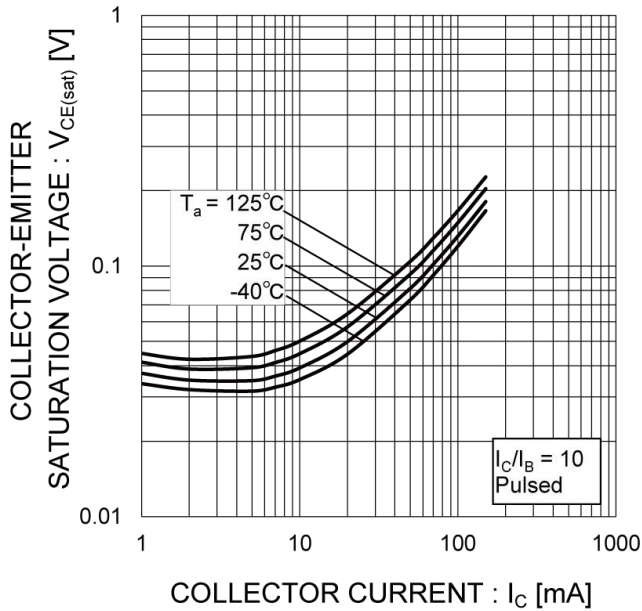

Fig.18 Collector-Emitter Saturation Voltage vs. Collector Current(II)

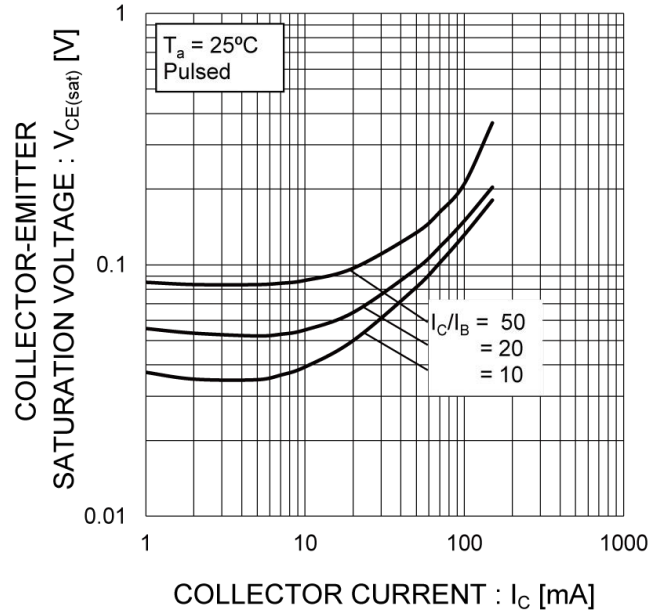

Fig.19 Base-Emitter Saturation Voltage vs. Collector Current (I)

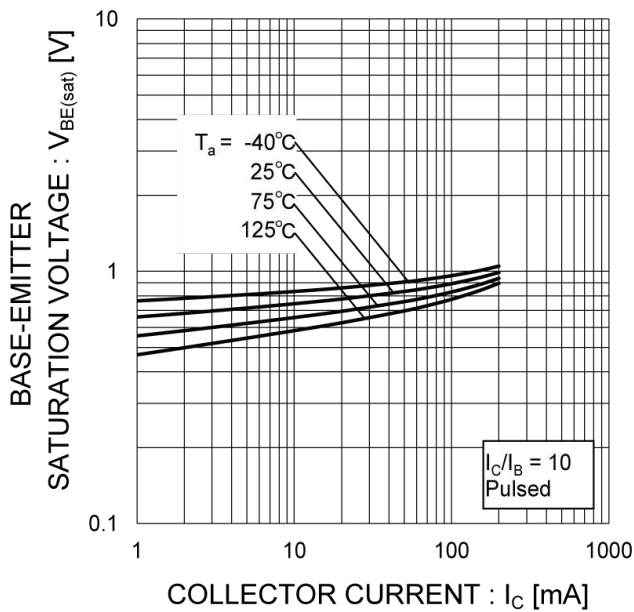
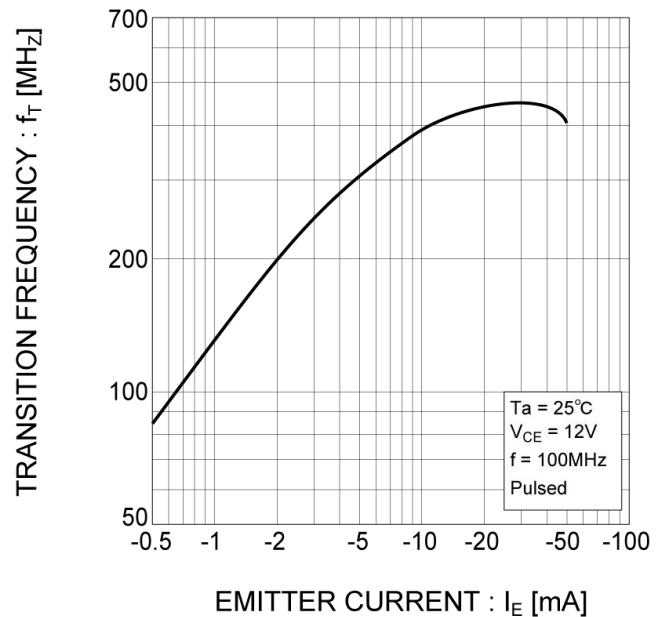

Fig.20 Gain Bandwidth Product vs. Emitter Current



●Electrical characteristic curves( $T_a = 25^\circ\text{C}$ ) <For TR2(NPN)>

Fig.21 Collector Output Capacitance vs. collector-Base Voltage  
Emitter Input Capacitance vs. Emitter-Base Voltage

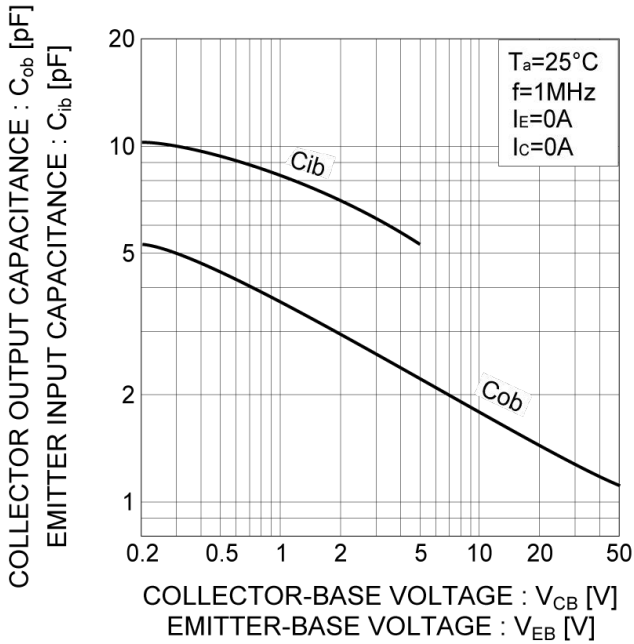

Fig.22 Safe Operating Area

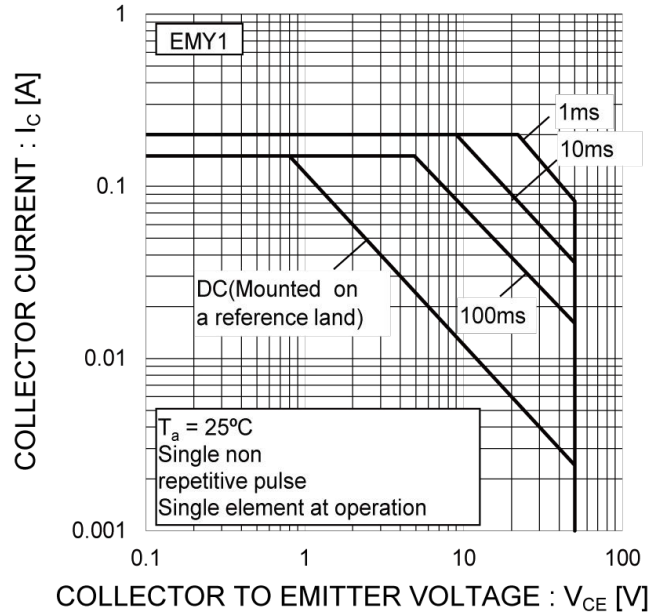

Fig.23 Safe Operating Area

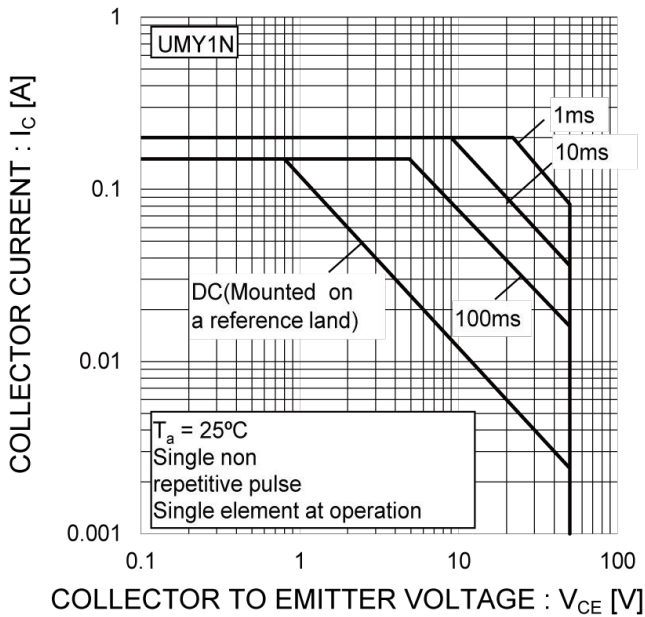
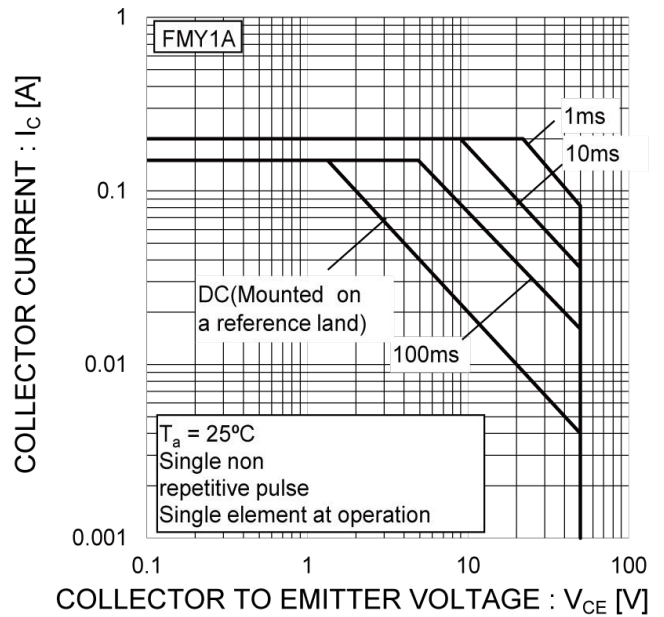
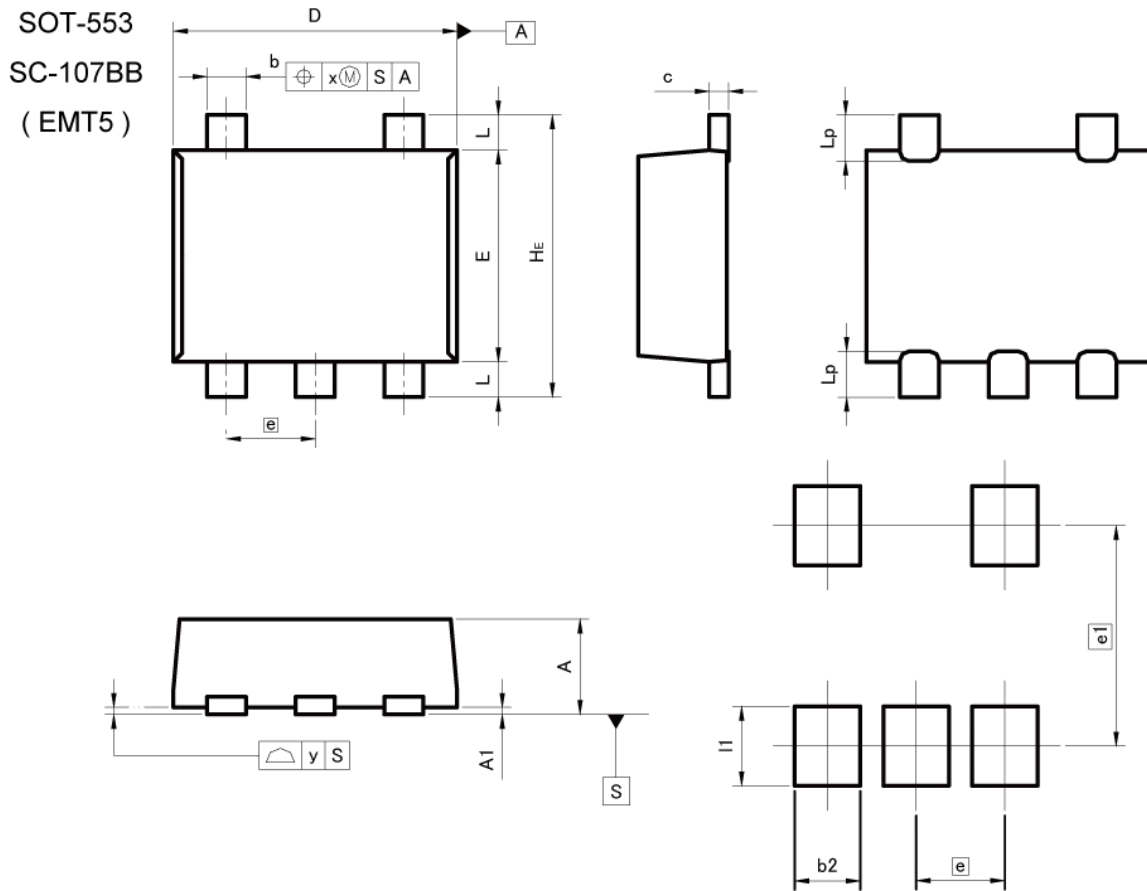

Fig.24 Safe Operating Area



●Dimensions



Pattern of terminal position areas  
[Not a pattern of soldering pads]

DIM	MILIMETERS		INCHES	
	MIN	MAX	MIN	MAX
A	0.45	0.55	0.018	0.022
A1	0.00	0.10	0.000	0.004
b	0.17	0.27	0.007	0.011
c	0.08	0.18	0.003	0.007
D	1.50	1.70	0.059	0.067
E	1.10	1.30	0.043	0.051
e	0.50		0.020	
HE	1.50	1.70	0.059	0.067
L	0.10	0.30	0.004	0.012
Lp	-	0.35	-	0.014
x	-	0.10	-	0.004
y	-	0.10	-	0.004

  

DIM	MILIMETERS		INCHES	
	MIN	MAX	MIN	MAX
b2	-	0.37	-	0.015
e1	1.25		0.049	
I1	-	0.45	-	0.018

Dimension in mm/inches

●Dimensions

SOT-353  
SC-88A  
(UMT5)

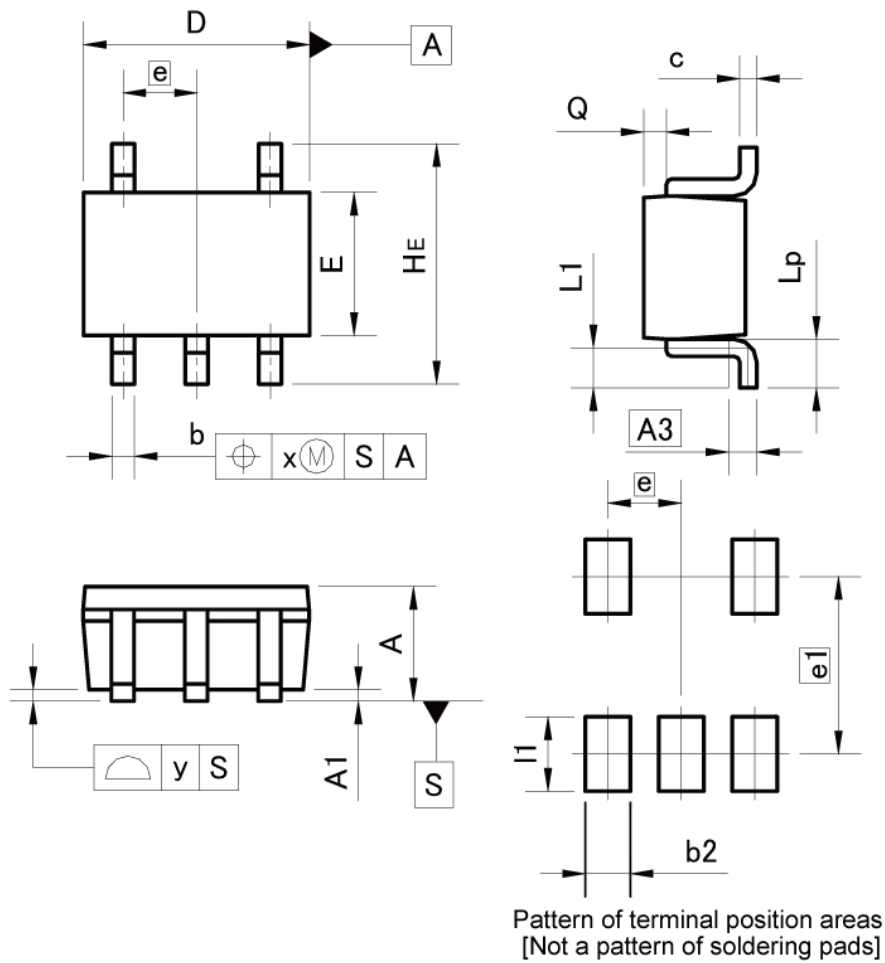

DIM	MILIMETERS		INCHES	
	MIN	MAX	MIN	MAX
A	0.80	1.00	0.031	0.039
A1	0.00	0.10	0.000	0.004
A3	0.25		0.010	
b	0.15	0.30	0.006	0.012
c	0.10	0.20	0.004	0.008
D	1.90	2.10	0.075	0.083
E	1.15	1.35	0.045	0.053
e	0.65		0.026	
HE	2.00	2.20	0.079	0.087
L1	0.20	0.50	0.008	0.020
Lp	0.25	0.55	0.010	0.022
Q	0.10	0.30	0.004	0.012
x	-	0.10	-	0.004
y	-	0.10	-	0.004

DIM	MILIMETERS		INCHES	
	MIN	MAX	MIN	MAX
b2	-	0.40	-	0.016
e1	1.55		0.061	
l1	-	0.65	-	0.026

Dimension in mm/inches

●Dimensions

SOT-25  
SC-74A  
(SMT5)

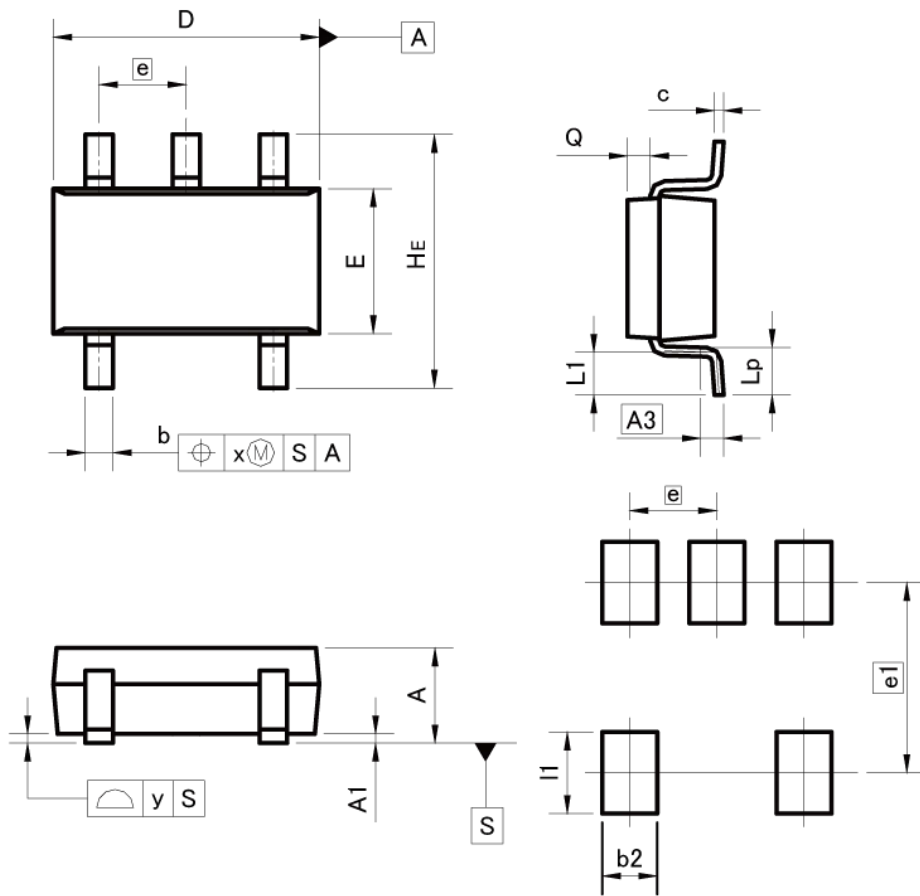

Pattern of terminal position areas  
[Not a pattern of soldering pads]

DIM	MILIMETERS		INCHES	
	MIN	MAX	MIN	MAX
A	1.00	1.30	0.039	0.051
A1	0.00	0.10	0.000	0.004
A3	0.25		0.010	
b	0.25	0.40	0.010	0.016
c	0.09	0.25	0.004	0.010
D	2.80	3.00	0.110	0.118
E	1.50	1.80	0.059	0.071
e	0.95		0.037	
HE	2.60	3.00	0.102	0.118
L1	0.30	0.60	0.012	0.024
Lp	0.40	0.70	0.016	0.028
Q	0.20	0.30	0.008	0.012
x	-	0.20	-	0.008
y	-	0.10	-	0.004

DIM	MILIMETERS		INCHES	
	MIN	MAX	MIN	MAX
b2	-	0.60	-	0.024
e1	2.10		0.083	
l1	-	0.90	-	0.035

Dimension in mm/inches

## Notes

- 1) The information contained herein is subject to change without notice.
- 2) Before you use our Products, please contact our sales representative and verify the latest specifications :
- 3) Although ROHM is continuously working to improve product reliability and quality, semiconductors can break down and malfunction due to various factors. Therefore, in order to prevent personal injury or fire arising from failure, please take safety measures such as complying with the derating characteristics, implementing redundant and fire prevention designs, and utilizing backups and fail-safe procedures. ROHM shall have no responsibility for any damages arising out of the use of our Products beyond the rating specified by ROHM.
- 4) Examples of application circuits, circuit constants and any other information contained herein are provided only to illustrate the standard usage and operations of the Products. The peripheral conditions must be taken into account when designing circuits for mass production.
- 5) The technical information specified herein is intended only to show the typical functions of and examples of application circuits for the Products. ROHM does not grant you, explicitly or implicitly, any license to use or exercise intellectual property or other rights held by ROHM or any other parties. ROHM shall have no responsibility whatsoever for any dispute arising out of the use of such technical information.
- 6) The Products are intended for use in general electronic equipment (i.e. AV/OA devices, communication, consumer systems, gaming/entertainment sets) as well as the applications indicated in this document.
- 7) The Products specified in this document are not designed to be radiation tolerant.
- 8) For use of our Products in applications requiring a high degree of reliability (as exemplified below), please contact and consult with a ROHM representative : transportation equipment (i.e. cars, ships, trains), primary communication equipment, traffic lights, fire/crime prevention, safety equipment, medical systems, servers, solar cells, and power transmission systems.
- 9) Do not use our Products in applications requiring extremely high reliability, such as aerospace equipment, nuclear power control systems, and submarine repeaters.
- 10) ROHM shall have no responsibility for any damages or injury arising from non-compliance with the recommended usage conditions and specifications contained herein.
- 11) ROHM has used reasonable care to ensure the accuracy of the information contained in this document. However, ROHM does not warrant that such information is error-free, and ROHM shall have no responsibility for any damages arising from any inaccuracy or misprint of such information.
- 12) Please use the Products in accordance with any applicable environmental laws and regulations, such as the RoHS Directive. For more details, including RoHS compatibility, please contact a ROHM sales office. ROHM shall have no responsibility for any damages or losses resulting non-compliance with any applicable laws or regulations.
- 13) When providing our Products and technologies contained in this document to other countries, you must abide by the procedures and provisions stipulated in all applicable export laws and regulations, including without limitation the US Export Administration Regulations and the Foreign Exchange and Foreign Trade Act.
- 14) This document, in part or in whole, may not be reprinted or reproduced without prior consent of ROHM.



Thank you for your accessing to ROHM product informations.  
More detail product informations and catalogs are available, please contact us.

**ROHM Customer Support System**

<http://www.rohm.com/contact/>

# Mouser Electronics

Authorized Distributor

Click to View Pricing, Inventory, Delivery & Lifecycle Information:

[ROHM Semiconductor:](#)

[EMY1T2R](#)